

COLLECTION 2019 | 01

Yeggam

feel comfortable



EXCLUSIVE DISTRIBUTION NEW COLLECTION 2019

Italy is home of good food and style, where hospitality is an art. We, Yegam, strive to create products that embody the italian spirit, while responding to the needs of professionals. All our products are not only truly beautiful. They are functional and practical. We put utmost attention to production processes and details to ensure maximum reliability. We believe in quality. Quality is value over time!

Yegam
feel comfortable

indice



CATALOG PART 1

BUFFET

Modular buffet table AirBuffet	18
Modular buffet system Domino	24
Combinations	30
Single unit	36
Warmer	47
Magnetic induction platform	48
Led buffet table & accessories	50
Carving station and heating lamps	54
Domino light	60
Induction chafing dishes	62
Induction chafing dishes collections	64
Artisan	80
Induction hob	86
Roll top chafing dishes	88
Roll top chafing dishes collections	90
Electric heaters	97
Mini chafing dishes collections	98
Chafing dishes accessories	100
Ceramic coated	108
Serving spoons	110
Urns and dispensers	112
Soup and coffee urns collections	114
Dispensers collections	120
Buffet presentation	134
Stands and risers	138
Vassoio pasticceria	152
Displays	156
Trays	158
Bowls	168
Stands	172
Wooden boxes	194
Presentation sets	202
Room service trolleys & hot food warmer	204



CATALOG PART 2

TABLE TOP

New bone china Luzerne	210
Coloured ware collections	212
White ware collections	232
Hollowware	262
Coffee & tea pots	266
Water pitchers	267
Duble wall coffee pots & Thermos	268
Wine coolers	270
Others	276
Bread Basket	280
Cutlery	282
Table mats	300



CATALOG PART 3

HAPPY HOUR

Le lattine	304
Street food	308
Cocktail	316
Vassoi e piatti	334
Legno	348

The soul of stylish vintage combined with old-world charm.



There is something to be said about nostalgia when it comes to vintage trend. Aspiring the trend from another period can be a sort of escape or consolation from contemporary stresses for the people of twenty-first century.

That vintage style keeps 1920s fashions at its core because in many respects, 1920s American society represents the good old days of prosperity. It was a decade of indulgence, rapid economic growth.

The Artisan, premium aluminum casting chafer. The comfort of home served by professionals.



















COLLECTION 2019 | PART 1

buffet

IN ASSOCIATION WITH TIGER COMPANY



Modular buffet table AirBuffet



Modular design table. Steel structure, with a choice of shapes and sizes. Shelves available in methacrylate and wood. Easy to assemble, store and transport. Complete of accessories to set up a modern and attractive buffet.

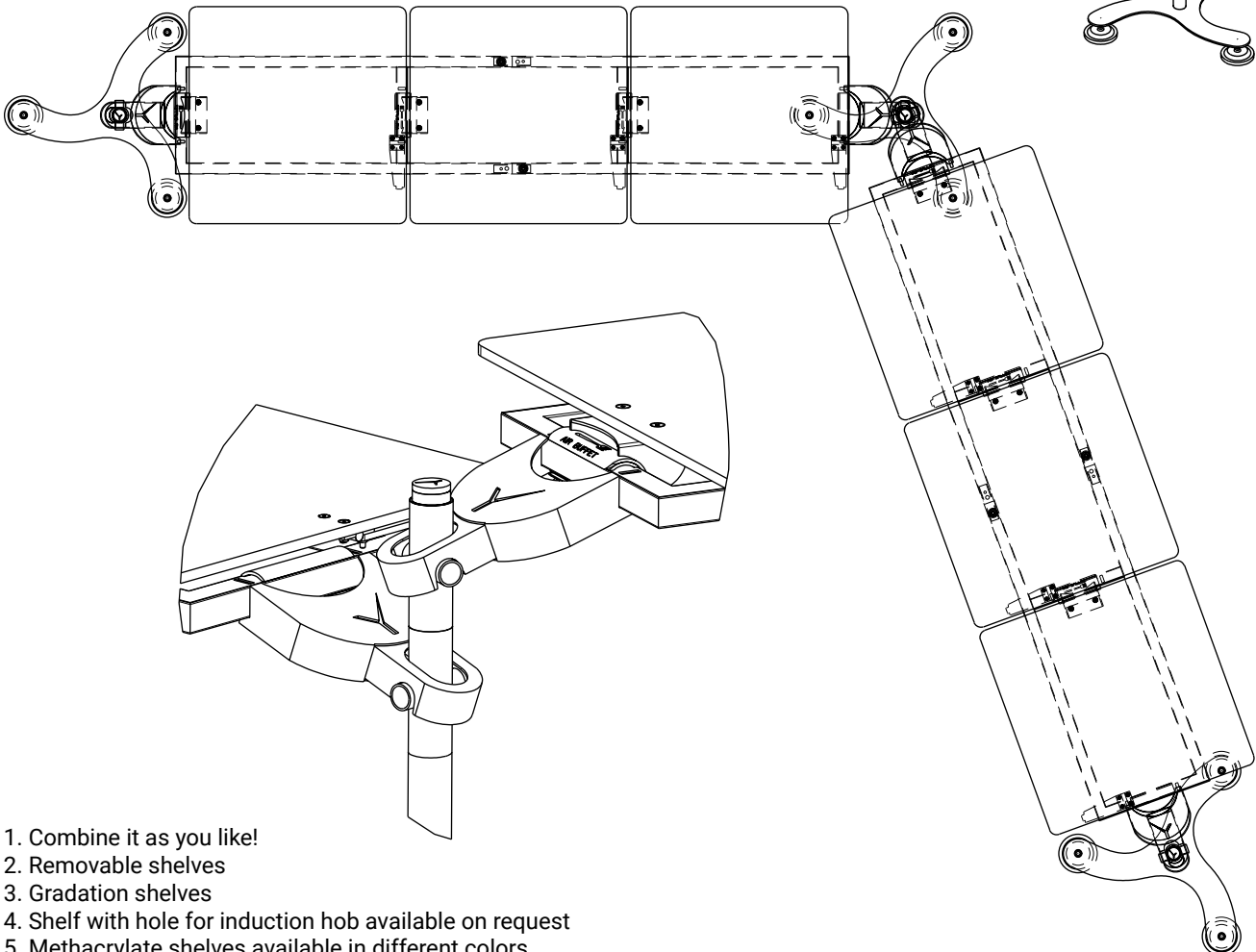
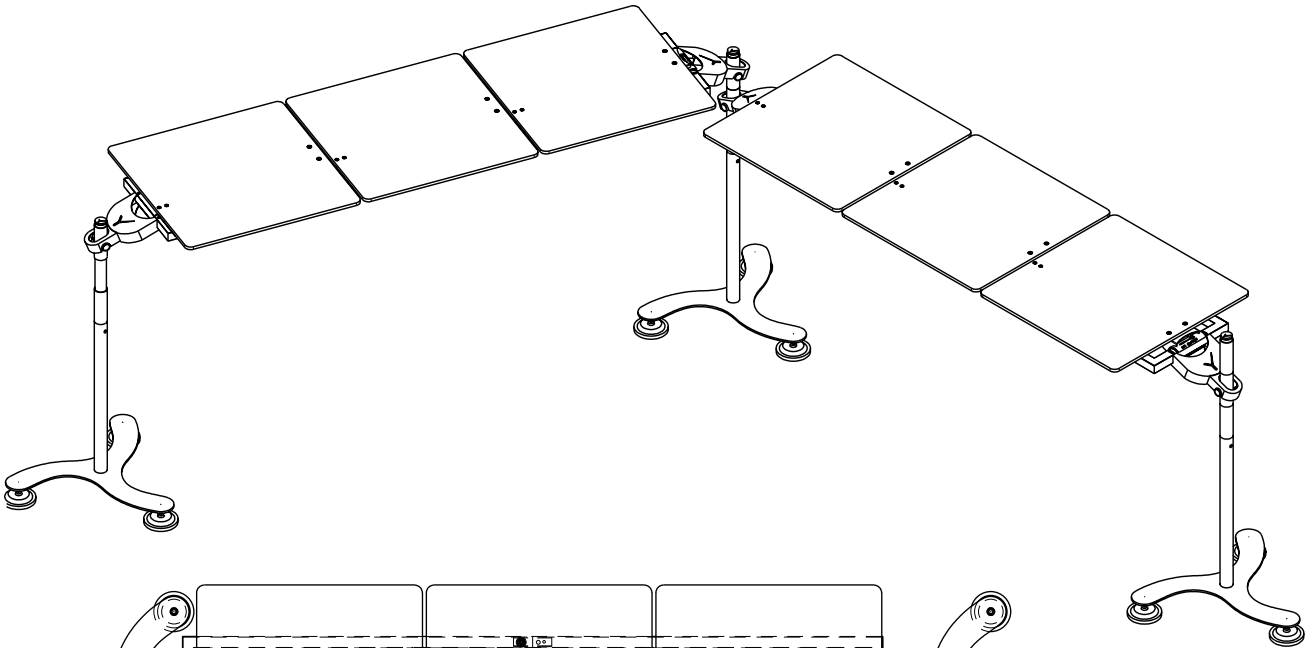
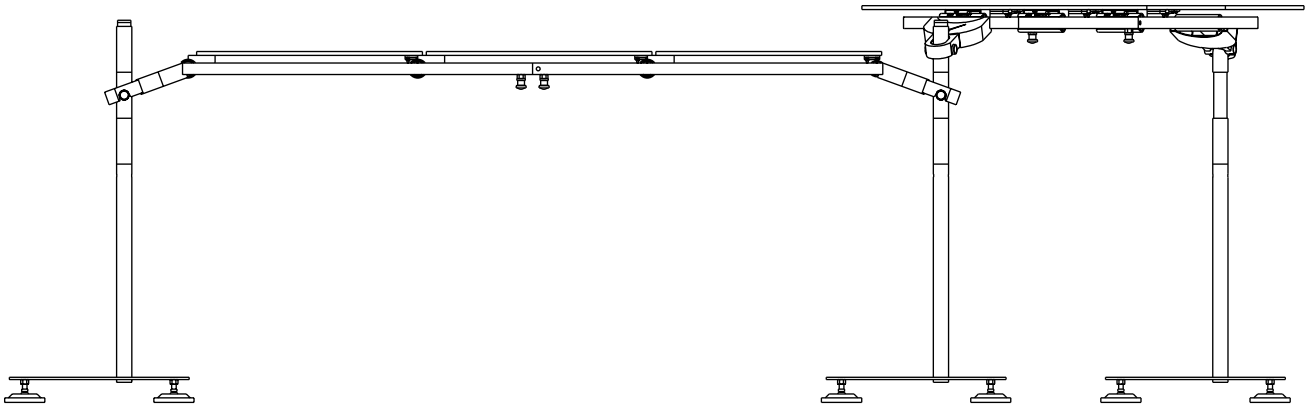

1. Combine it as you like!
2. Removable shelves
3. Gradation shelves
4. Shelf with hole for induction hob available on request
5. Methacrylate shelves available in different colors



AIR-BASIC: 3 legs + 2 bars + 6 plexi shelves standard
AIR - SHELF: Standard Shelf
AIR-IND: Shelf with hole for induction hob
AIR-LEG: Complete leg
AIR-BAR: complete supporting bar

3 COLORS AVAILABLE





Modular buffet system-Domino



Domino is a completely new concept in modular buffet system. All the Domino components can interlock or stand alone. Simply connect components to build your designed buffet. When tomorrow comes build it again or try something new. Domino is made from food grade 18/10 Stainless steel. Built and design to endure the abuse of a commercial operation. Domino heated components can use caned fuel or electric; domino's easy lock & unlock leg system makes it simple to change height; no tools or complicated instructions; simply insert and twist. The base modules consist of 3 sizes: 25 cm (9.75") square; 35 cm (13.75") square; 62x35 cm (24.25" x 13.75") rectangle. Each base unit is 9 cm (3.50") tall. The unit can simply share legs or the height can be increased by 9 cm (3.50") increments to create beautiful high and low horizon on the buffet scene. To add a leg/height just insert and twist. No tools required. You build it and they will come. **Let your imagination design your Buffet. The system is so simple, a child can do it. Simply put, Domino makes it fun again!**

PATENT KOREA: 20-0458123; 20-0481867; 30-0601673. PATENT CHINA: 2448616; 1959783.

ASSEMBLE YOUR DOMINO AND MAKE YOUR OWN.



1. All components interchangeable
2. Easy lock & unlock leg system
3. Stackable stand
4. Corner to corner linkable system
5. Easy building blocks for better buffet

THE BUILDING BLOCKS FOR A BETTER BUFFET IS BEYOND YOUR IMAGINATION!



Risers and displays
Juice/milk/cereal dispensers
Carving boards
Heating lamps
Dome covers
Soup and hot stations
Condiment stands
Sauce chafers
Chafing dishes
Chafing dishes
Magnetic induction platforms
Utensils

DOMINO IS THE BEST CHOICE!



THE SYSTEM GIVES YOU THE FLEXIBILITY TO COMPLETELY REDESIGN YOUR BUFFETS BASED ON YOUR MENU.

EVERY DAY DOMINO GIVES YOU A NEW CANVAS TO WORK WITH.



COOKING IS ART. DOMINO IS YOUR CANVAS.

DOMINO SQUARE MODULE 25 CM.



DOMINO SQUARE MODULE 35 CM.



DOMINO RECTANGULAR MODULE 62X35 CM.



DOMINO ACCESSORIES COMPATIBLE WHIT ALL MODULES.



DOMINO COMBINATION

These 7 demonstration of the Domino modular buffet is just one of thousands combinations that you can make.





Domino Bread & CO. - Bread station

Code: 19425-000

Items: 19411-090; 19413-090; S1-19402-260 (x2); 19402-180; 19413-BGT



Domino Sushi & Roll - Cold station

Code: 19431-000

Items: 19415-090 (x2); 11206-250; 11207-250 (x2); 19414-090 (x2); S1-19402-260



Domino Cereal Fantasia 1 - Cereal station

Code: 19427-000

Items: 19412-090 (x2); 19404-180



Domino Vita ACE 1 - Juice station

Code: 19429-000

Items: 19403-180 (x3); S1-19402-260



Domino Sweet Treat Station - Dessert station

Code: 19433-000

Items: 19405-090 (x4); 19405-PCB; 19406-090; 11206-250; 19414-090; S1-19402-260 (x3); 19405-WNT (x2); 19421; 18929



Domino hot station

Code: 19432-000

Item: 19407-180; 19406-090; 19405-180; 19405-IDT; 19406-IDT; 15800-CHO; 15801-CHO; 11762-230 (x2)





Domino Green Therapy - Salad Station

Code: 19426-000

Item: 19402-090 (x2); 19403-PCB (x2); 19405-180; 19405-PCB (x2); 19406-180; 11207-250 (x2); S1-19402-206 (set); 19409-180 (x2); 19423



DOMINO SINGLE UNIT



Domino sauce chafing dish

Material: Stainless steel 18-10; Porcelain; Corian

Code: 19401-180

Size: L250 x W250 x H312 mm

Weight: 5.56 kg

Capacity: 0.8 Ltr



Domino juice dispenser - single (3.5 Ltr)

Material: Stainless steel 18-10; Polycarbonate cylinder; Acacia wood

Code: 19403-180

Size: L250 x W330 x H434 mm

Weight: 6.68 kg

Capacity: 3.5 Ltr



Domino milk dispenser (5 Ltr)

Material: Stainless steel 18-10; Acacia wood

Code: 19404-180

Size: L250 x W324 x H458 mm

Weight: 7.06 kg

Capacity: 5.0 Ltr



Domino coffee urn (3.8 Ltr)

Material: Stainless steel 18-10

Code: 19435-180

Size: L255 x W322 x H423 mm

Weight: 4.31 kg

Capacity: 3.8 Ltr



Domino cereal dispenser - single (3.7 Ltr, 9 cm)

Material: Stainless steel 18-10; Polycarbonate cylinder

Code: 19412-090

Size: L250 x W264 x H621 mm

Weight: 5.06 kg

Capacity: 3.7 Ltr



Domino cereal dispenser - single (3.7 Ltr, 18 cm)

Material: Stainless steel 18-10; Polycarbonate cylinder; Acacia wood

Code: 19412-180

Size: L250 x W264 x H713 mm

Weight: 7.32 kg

Capacity: 3.7 Ltr



Domino dish stand (25x9 cm)

Material: Stainless steel 18-10

Code: 19402-090

Size: L250 x W250 x H103 mm

Weight: 1.84 kg

Compatible with: Chafing dishes accessories



Domino dish stand bronze vintage (25x9 cm)

Material: Bronze PVD coated Stainless steel; Stainless steel 18-10

Code: 19402-090-BRZ

Size: L250 x W250 x H103 mm

Weight: 1.84 kg

Compatible with: Chafing dishes accessories



Domino dish stand (25x18 cm)

Material: Stainless steel 18-10; Acacia wood

Code: 19402-180

Size: L250 x W250 x H196 mm















Weight: 4.10 kg

Compatible with: Chafing dishes accessories



NEW



<p>Domino porcelain bowl (25 cm) Material: Porcelain Code: 19403-PCB Package: 3 ea Size: L235 x W125 x H100 mm Weight: 1.24 kg Capacity: 1.1 Ltr</p> 	<p>Domino soup station stand Material: Stainless steel 18-10; Corian Code: 19407-180 Size: L350 x W350 x H323 mm Weight: 8.74 kg Capacity: 4.2 Ltr</p>  <p> WARM</p>	<p>Domino hot station stand Material: Stainless steel 18-10; Corian Code: 19408-180 Size: L350 x W350 x H196 mm Weight: 8.34 kg Capacity: 4.5 Ltr</p>  <p> WARM</p>
<p>Domino dish stand (35x9 cm) Material: Stainless steel 18-10 Code: 19405-090 Size: L350 x W350 x H103 mm Weight: 2.08 kg Compatible with: Chafing dishes accessories</p>  <p> STACKABLE</p>	<p>Domino dish stand bronze vintage (35x9 cm) Material: Bronze PVD coated Stainless steel; Stainless steel 18-10 Code: 19405-090-BRZ Size: L350 x W350 x H103 mm Weight: 2.08 kg Compatible with: Chafing dishes accessories</p>  <p> STACKABLE</p> <p> VINTAGE DESIGN PREMIUM QUALITY</p>	<p>Domino dish stand (35x18 cm) Material: Stainless steel 18-10; Acacia wood Code: 19405-180 Size: L350 x W350 x H196 mm Weight: 5 kg Compatible with: Chafing dishes accessories</p>  <p> STACKABLE</p>
<p>Domino porcelain bowl (35 cm) Material: Porcelain Code: 19405-PCB Package: 3 ea Size: L340 x W340 x H110 mm Weight: 2.50 kg Capacity: 3 Ltr</p> 	<p>Domino wooden tray Material: Acacia wood Code: 19405-WNT Size: D332 x H25 mm Weight: 0.8 kg</p> 	<p>Domino marble tray Material: Corian Code: 19405-MBT Size: D330 x H22 mm Weight: 1.82 kg</p> 

NEW



Domino complete bread cutting board

Material: Stainless steel 18-10; Acacia wood

Code: 19411-090

Size: L615 x W350 x H116 mm

Weight: 5.86 kg



STACKABLE



Domino complete bread basket

Material: Stainless steel 18-10; Polycarbonate dome cover; PE

Code: 19413-090

Size: L615 x W355 x H297 mm

Weight: 6.46 kg



Domino bread basket

Material: PE

Code: 19413-BAS

Size: L490 x W305 x H100 mm

Weight: 0.78 kg





Domino cold display with dome cover
 Material: Stainless steel 18-10; Polycarbonate dome cover

Code: 19414-090
 Size: L615 x W355 x H297 mm
 Weight: 9.82 kg
 Compatible with: PC Dome Cover 19927



Domino cold display without dome cover
 Material: Stainless steel 18-10

Code: 19415-090
 Size: L615 x W350 x H103 mm
 Weight: 7.88 kg



Domino Dome Cover
 Material: Polycarbonate dome cover

Code: 19927-BOM
 Size: L575 x W355 x H216 mm
 Weight: 1.94 kg





Domino oblong dish stand (9 cm)

Material: Stainless steel 18-10

Code: 19406-090

Size: L615 x W350 x H101 mm

Weight: 2.76 kg

Compatible with: Chafing dishes accessories



STACKABLE



Domino oblong dish stand bronze vintage (9 cm)

Material: Bronze PVD coated Stainless steel; Stainless steel 18-10

Code: 19406-090-BRZ

Size: L615 x W350 x H101 mm

Weight: 2.76 kg

Compatible with: Chafing dishes accessories



STACKABLE



NEW

Domino oblong dish stand (18 cm)

Material: Stainless steel 18-10; Acacia wood

Code: 19406-180

Size: L615 x W350 x H196 mm

Weight: 6.76 kg

Compatible with: Chafing dishes accessories



STACKABLE





Domino oblong wooden tray

Material: Acacia wood

Code: 19406-WNT

Size: L527 × W321 × H28 mm

Weight: 1.68 kg



Domino bread cutting board

Material: Acacia wood

Code: 19411-BCB

Size: L526 × W325 × H28 mm

Weight: 1.10 kg



Domino oblong marble tray

Material: Corian

Code: 19406-MBT

Size: L525 × W325 × H22 mm

Weight: 3.64 kg





Domino buffet display 1 tier

Material: Stainless steel 18-10; PMMA (Acrylic)

Code: 19437-090 (black), 19436-090 (white)

Size: L615 x W250 x H103.5 mm

Weight: 2.5 kg



Domino buffet display 2 tiers

Material: Stainless steel 18-10; PMMA (Acrylic)

Code: 19437-180 (black), 19436-180 (white)

Size: L615 x W427 x H196 mm

Weight: 5.2 kg



Domino buffet display 3 tiers









Material: Stainless steel 18-10; PMMA (Acrylic)

Code: 19437-270 (black), 19436-270 (white)

Size: L615 x W604 x H288.5 mm

Weight: 8.3 kg



<p>Domino extensible legs Material: Stainless steel 18-10; ABS</p> <p>Code: S1-19402-260 Package: 4 pcs/set Size: D28 × H105 mm Weight: 0.16 kg (1 ea)</p> 	<p>Domino square wooden base Material: Acacia wood</p> <p>Code: K1-19402-270 Size: L250 × W250 × H15 mm Weight: 0.86 kg</p> <p>Code: K1-19405-270 Size: L350 × W350 × H15 mm Weight: 1.54 kg</p> <p>Code: K1-19406-270 (oblong) Size: L615 × W350 × H15 mm Weight: 1.9 kg</p> 	<p>Domino condiment pole Material: Stainless steel 18-10; Porcelain</p> <p>Code: 19410-180 Package: 2 bowls and pole Size: L290 × W252 × H80 mm Weight: 2.22 kg</p> 
<p>Domino condiment pole Material: Stainless steel 18-10; Porcelain; Silicone</p> <p>Code: 19410-090 Package: 1 bowls and pole Size: L140 × W234 × H229 Weight: 1.15 kg</p> 	<p>Domino condiment porcelain Material: Porcelain</p> <p>Code: 11220-000 Package: 2 pcs/set Size: L177 × W118 × H48 mm Weight: 0.28 kg (1 ea) Capacity: 0.35 Ltr (1 ea)</p> 	<p>Domino serving utensil pole Material: Stainless steel 18-10; Porcelain</p> <p>Code: 19409-180 Package: 1 spoons, 1 fork and pole Size: L174 × W149 × H370 mm Weight: 1.62 kg Capacity: 0.35 Ltr (1 ea)</p> 
<p>Domino porcelain holder Material: Porcelain</p> <p>Code: 11223-000 Package: 2 pcs/set Size: D78 × H120 mm Weight: 0.44 kg (1 ea) Capacity: 0.35 Ltr (1 ea)</p> 	<p>Domino serving cutlery Material: Stainless steel 18-10</p> <p>Code: 11514-000 (fork) Package: 6 ea/set Size: L36 × W22 × H277 mm Weight: 0.20 kg (1 ea)</p> <p>Code: 11515-000 (spoon) Package: 6 ea/set Size: L55 × W26 × H280 mm Weight: 0.20 kg (1 ea)</p> 	

NEW



Domino utility stand

Material: Stainless steel 18-10; Porcelain; PMMA (Acrylic)
Platform not included

Code: 19423-000
Size: L337 x W270 x H487 mm
Weight: 3.71 kg



Domino fruit bowl (9 Ltr)

Material: Stainless steel 18-10; Acacia wood

Code: 19421-000
Size: L331 x W349 x H509 mm
Weight: 2.28 kg
Capacity: 9 Ltr



Domino napkin holder

Material: Stainless steel 18-10; Acacia wood

Code: 19422-000
Size: D206 x H176 mm
Weight: 0.9 kg



DOMINO CROISSANT (BREAD) WARMER



Domino croissant warmer

Material: Stainless steel 18-10; PE basket; Ceramic coated aluminium sheathed plate; PPS

Code: 19438-230

Heating plate: 230 V, 490 W

Size: L615 × W361 × H287 mm

Weight: 11 kg

Relate accessories: 11206-250, 11207-250



Croissant warmer can be also used as regular warmer for dry food.

DOMINO MAGNETIC INDUCTION PLATFORM

We proudly present the most Green and eco-friendly induction-heated banqueting equipment in the world. Not only does switching to induction enable you to help conserve materials, keep used fuel cans out of landfills, and eliminate greenhouse gas emissions, but switching to our particular product also allows you to warm food using 69% less electricity while impressing your guests with your conservation efforts.



Domino magnetic induction platform (square)

The 4 magnetics ensure the tight hold of the chafer onto the platform.

Material: Acacia wood; Magnet

Code: 19405-IDT

Size: L350 x W350 x H40.6 mm

Weight: 0.95 kg



Domino magnetic induction platform (oblong)

The 4 magnetics ensure the tight hold of the chafer onto the platform.

Material: Acacia wood; Magnet

Code: 19406-IDT

Size: L618 x W353 x H40.6 mm

Weight: 1.73 kg





Induction warmer (mini round, 300W)

Material: Stainless steel 18-10

Code: 11764-230

Size: D180 × H81.5 mm

Weight: 1.55 kg



Hold temperature of any Tiger induction chafier with only 300W max absorption. It can stay in operation without control panel up to 4 hours.

NEW

INDUCTION WARMER 11764-230

Product features:

- Safety Start Up
- Small Object Detection
- Empty Pot Detection
- Overheat Protection



Specification:

Model	11764-230
Voltage	220-230V
Frequency	50/60Hz
Dimension	Dia. 180 × H81.5
Power Consumption	300W
Weight	1400g

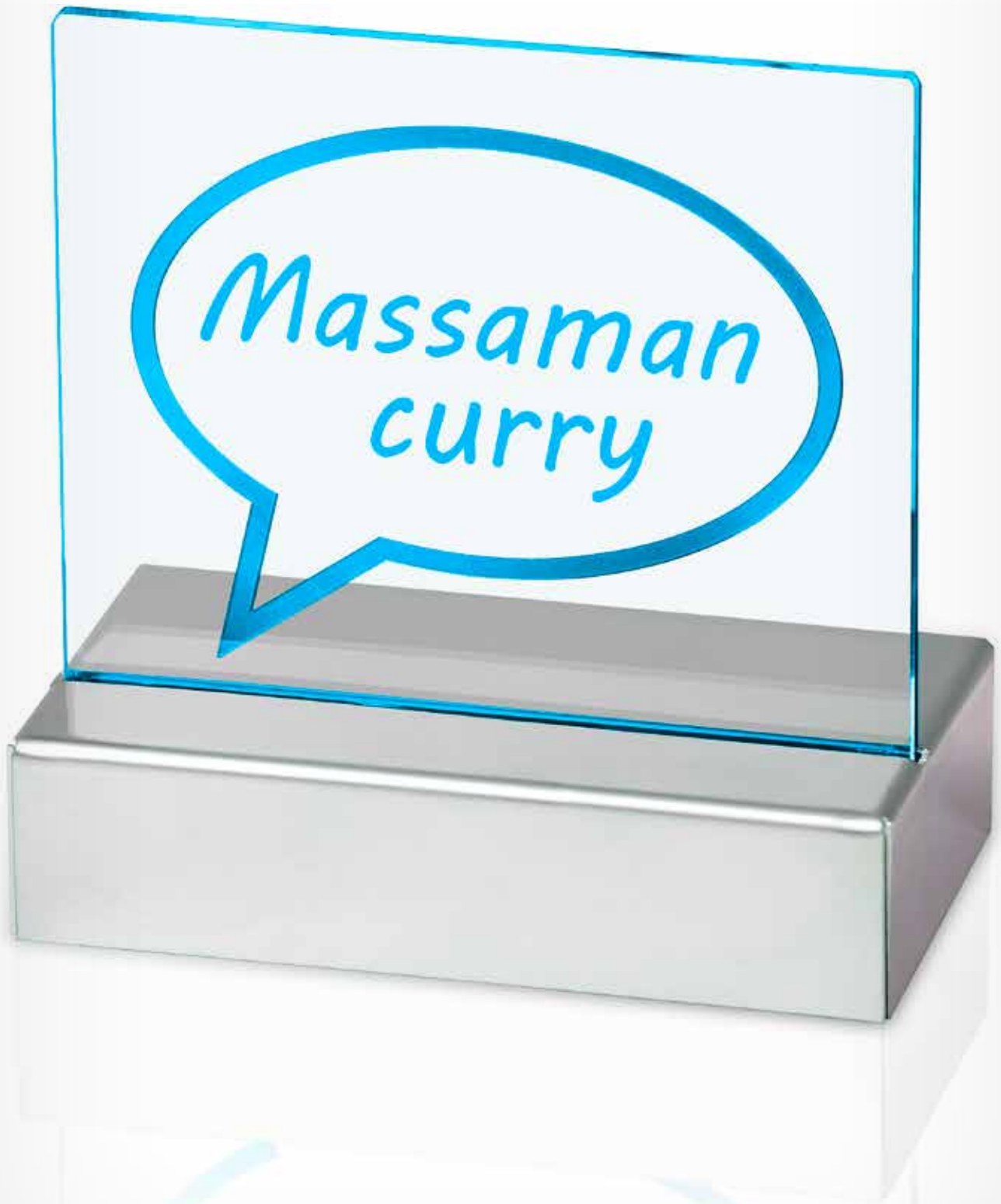

*Massaman
curry*

LED buffet & table accessories



LED LIGHT PRODUCTS



Write with white neon marker and choose the color you like!

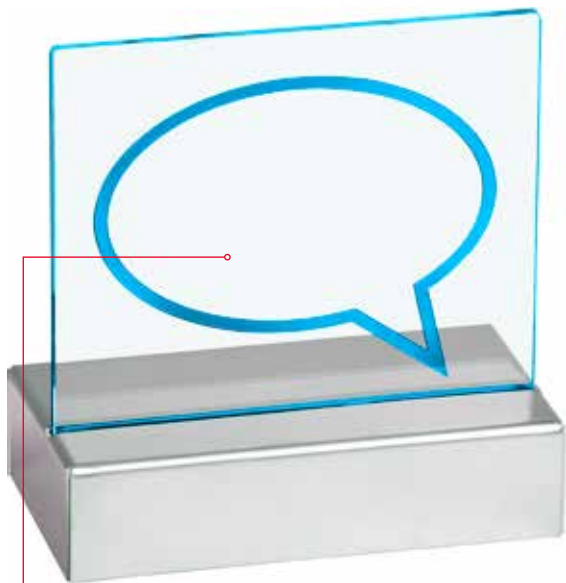

Lasting 30 hours for one-time charge!

LED light menu stand

Material: Stainless steel 18-10; Silicone; ABS; PMMA(Acrylic); PCB; Power supply; USB cable

Code: 19943-230

Size: L133 × W70 × H134.7 mm
Weight: 0.35 kg



NEW

LED table No. stand style1

Material: Stainless steel 18-10; Silicone; ABS; PMMA(Acrylic); PCB; Power supply; USB cable

Code: 19945-230-001

Size: L133 × W70 × H344.7 mm
Weight: 0.45 kg



NEW

LED table No. stand style 2

Material: Stainless steel 18-10; Silicone; ABS; PMMA(Acrylic); PCB; Power supply; USB cable

Code: 19945-230-002

Size: L133 × W70 × H344.7 mm
Weight: 0.40 kg



NEW

White Neon maker pan

Code: 19011-100



NEW

Mobil sneeze guard with LED writable

Material: Stainless steel 18-10; PMMA (Acrylic); Silicone; ABS; PCB; Power supply; USB cable

Code: 19012-230; 19012-110

Size: L754.4 × W342 × H556 mm
Max: 556 mm; Min: 416 mm
Weight: 4.10 kg



Height adjustable

NEW

Mobil sneeze guard writable

Material: Stainless steel 18-10; PMMA (Acrylic); Silicone

Code: 19011-000

Size: L754.4 × W342 × H556 mm
Max: 556 mm; Min: 416 mm
Weight: 3.80 kg



Height adjustable

NEW



Carving stations & heating lamps



T-COLLECTION CARVING STATIONS AND HEATING LAMPS





T-Collection heating lamp stand gooseneck bronze vintage 110V & 230V

Material: Bronze PVD coated Stainless steel; Stainless steel 18-10; Solid die casting; Powder coated steel (black)

Code: 19448-110-BRZ
 Rating: 110V, 250W / 230V, 375W (max)
 Size: L363.7 x W210 x H761 mm
 Weight: 6.60 kg



NEW

T-Collection heating lamp stand gooseneck 2-light bronze vintage 110V & 230V

Material: Bronze PVD coated Stainless steel; Stainless steel 18-10; Solid die casting; Powder coated steel (black)

Code: 19449-110-BRZ
 Rating: 110V, 250W / 230V, 375W (max)
 Size: L304.4 x W474.8 x H761 mm
 Weight: 7.45 kg



NEW



Different cables are available on request

**T-Collection heating lamp stand gooseneck
110V & 230V**

Material: Stainless steel 18-10; Solid die casting; Powder coated steel (black); Powder coated steel

Code: 19446-230 & 19446-110
Rating: 110V, 250W / 230V, 375W (max)
Size: L404 x W196 x H761 mm
Weight: 5.71 kg



**T-Collection heating lamp stand gooseneck
2-light 110V & 230V**

Material: Stainless steel 18-10; Solid die casting; Powder coated steel (black); Powder coated stainless steel

Code: 19447-230 & 19447-110
Rating: 110V, 250W / 230V, 375W (max)
Size: L344 x W474.8 x H761 mm
Weight: 6.92 kg



**T-Collection rect. carving station base with
carving board**

Material: Stainless steel 18-10; Powder coated steel (black); Phenolic sheet (black) board

Code: 11763-000
Size: L768 x W592 x H125.5 mm
Weight: 13.8kg



T-Collection rect. fiber resin carving board

SGS approved No. TSNHG1500055102 A01
Material: Phenolic sheet (black)

Code: 11763-CVB-BLK
Size: L650 x W530 x H12 mm
Weight: 2.80kg



**Domino round carving station base with carving
board**

Material: Stainless steel 18-10; Phenolic sheet (black) board

Code: 11760-BSE
Size: L618 x W588 x H59.5 mm
Weight: 6.88kg



Fiber resin carving board (1 ea)

SGS approved No. TSNHG1500055102 A01
Material: Phenolic sheet

Code: 11760-CVB
Size: D495 x H12 mm
Weight: 3 kg



Domino heating lamp for 11760

Material: Stainless steel 18-10; Solid die casting; Aluminium; ABS (chrome plated)

Code: 19416-CS1
Rating: 110V, 250W / 230V, 375W (max)
Size: L176 x W350 x H626 mm
Weight: 1.8 kg
Compatible with: 11760-230



Domino round stackable carving station

Material: Stainless steel 18-10; Solid die casting; Phenol sheet

Code: 11760-230
Rating: 110V, 250W / 230V, 375W (max)
Size: L648 x W588 x H647 mm
Weight: 8.24 kg
Compatible with: 19416-CS1





FEATURE

1. No tools needed to remove heat lamp
2. All that touches food is dish washer safe
3. Liquid control in sub reservoir
4. Stackable for storage



BULB NOT INCLUDED IN THE HEATING LAMP

DOMINO CARVING STATIONS AND HEATING LAMPS



Heating lamp free stand (single lamp)

Material: Stainless steel 18-10; Solid die casting; Aluminium; ABS (chrome plated)

Code: 19417-110; 19417-230
Rating: 110V / 250W, 230V / 375W (max)
Size: L204 x W375 x H725 mm
Weight: 6.50 kg



Heating lamp free stand (single lamp)

Material: Stainless steel 18-10; Solid die casting; Aluminium; ABS (chrome plated)

Code: 19417-230-RGD (rose gold)
Rating: 110V / 250W, 230V / 375W (max)
Size: L204 x W375 x H725 mm
Weight: 6.50 kg



Heating lamp free stand (single lamp)

Material: Stainless steel 18-10; Solid die casting; Aluminium; ABS (chrome plated)

Code: 19417-230-BLK (black)
Rating: 110V / 250W, 230V / 375W (max)
Size: L204 x W375 x H725 mm
Weight: 6.50 kg



Domino heating lamp for clamp (single lamp)

Material: Stainless steel 18-10; Solid die casting; Aluminium; ABS (chrome plated)

Code: 19416-110; 19416-230
Rating: 110V, 250W / 230V, 375W (max)
Size: L176 x W350 x H657 mm
Weight: 2.34 kg





Induction chafing dishes



The induction chafing dishes from Tiger not only look great, but also are unique in design and effective in cost. This unit can be flush mounted utilizing induction heat, or our electric heater, or canned fuel. The clad bottom distributes heat evenly minimizing hot spots that cause food to stick and burn. The self-closing lid has adjustable patented hinges that will prevent food from getting cold. In addition, the lid can be removed with one hand for easy cleaning. The lid also has air vents that reduce condensation build up that could drip on the food. This condensation is captured by the water recycling system allowing less refilling of the water pan, decreasing labor costs. The handle keeps cool preventing burns. The entire chafer is repairable, making this a quality investment that will last for years to come.

THANKS TO ITS HIGH DENSITY MAGNETIC BOTTOM TIGER CHAFERS ARE THE MOST ENERGY EFFICIENT CHAFERS IN THE MARKET! SAVE ON THE ENERGY COST, CHOOSE SMART!

T-COLLECTION



FEATURE

1. Three interchangeable color bands
2. The revolutionary infinite stop motion hinge
3. Water recycling system with easy no mess clean-up
4. Stackable stands for convenient storage
5. Counter handle for easy, safe transport





Easy detachment of the cover for Cleaning.



Counter handle for easy transportation.



Level adjustable foot.



Stackable stand with magnetic burner holder.



Water recycling system.

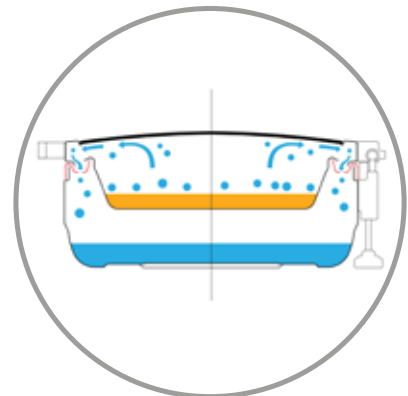



Compatible with stacking trolley Code: 91101.



Set includes chafer base, top, food pan & removable adaptor for easy water removal.



Infinite stop motion hinge™. Longer endurance with a quick easy adjustment.



T-Collection induction chafing dish (square)

Material: Stainless steel 18-10; Tempered glass; Solid die casting

Code: 15800-CHO

Size: L395 x W429.5 x H176.5 mm

Weight: 7.75 kg

Capacity: 5.5 Ltr



T-Collection induction chafing dish (square)

Material: Stainless steel 18-10; Tempered glass; Rose gold PVD coated stainless steel

Code: 15800-CHO-RGD (rose gold)

Size: L395 x W429.5 x H176.5 mm

Weight: 7.75 kg

Capacity: 5.5 Ltr



T-Collection induction chafing dish (square)

Material: Stainless steel 18-10; Tempered glass; Black PVD coated stainless steel

Code: 15800-CHO-BLK (black)

Size: L395 x W429.5 x H176.5 mm

Weight: 7.75 kg

Capacity: 5.5 Ltr



T-Collection induction chafing dish (round)

Material: Stainless steel 18-10; Tempered glass; Solid die casting

Code: 15801-CHO

Size: D420 x W484.5 x H155.5 mm

Weight: 7.6 kg

Capacity: 6 Ltr



T-Collection induction chafing dish (round)

Material: Stainless steel 18-10; Tempered glass; Rose gold PVD coated stainless steel

Code: 15801-CHO-RGD (rose gold)

Size: D420 x W484.5 x H155.5 mm

Weight: 7.6 kg

Capacity: 6 Ltr



T-Collection induction chafing dish (round)

Material: Stainless steel 18-10; Tempered glass; Black PVD coated stainless steel

Code: 15801-CHO-BLK (black)

Size: D420 x W484.5 x H155.5 mm

Weight: 7.6 kg

Capacity: 6 Ltr



T-Collection stackable stand (square)

Material: Stainless steel 18-10; PE; Powder coated steel;

Magnetic burner holder included

Can be used with induction warmer 11762-230 and magnetic induction lid 11123-000.

Code: 11281-000

Size: L465 x W372 x H251 mm

Weight: 3.92 kg



T-Collection stackable stand (round)

Material: Stainless steel 18-10; PE; Powder coated steel;

Magnetic burner holder included

Can be used with induction warmer 11762-230 and magnetic induction lid 11123-000.

Code: 11282-000

Size: D500 x W456 x H244 mm

Weight: 3.8 kg



Induction warmer

Code: 11764-230 (mini round, 300W)

Magnetic fixing ring for 11762

Code: 11123-000



See induction hob pages for specification



T-Collection rose gold band (square)

Material: Stainless steel 18-10; Rose gold PVD coated stainless steel; Silicone

Code: S1-15800-100-RGD

Size: L393 x W370 x H26 mm
Weight: 0.65 kg



T-Collection black band (square)

Material: Stainless steel 18-10; Black PVD coated stainless steel; Silicone

Code: S1-15800-100-BLK

Size: L393 x W370 x H26 mm
Weight: 0.65 kg



T-Collection rose gold band (round)

Material: Stainless steel 18-10; Rose gold PVD coated stainless steel; Silicone

Code: S1-15801-100-RGD

Size: D420 x H21 mm
Weight: 0.5 kg



T-Collection black band (round)

Material: Stainless steel 18-10; Black PVD coated stainless steel; Silicone

Code: S1-15801-100-BLK

Size: D420 x H21 mm
Weight: 0.5 kg



SMART W COLLECTION

While inheriting the legacy of Smart chafer, Smart W has been upgraded and enhanced with 100,000 times of opening and closing guarantee on the hinge mechanism and fun, futuristic modern design. PVD treatment available in rose gold or black.



Special finishing available on request for all Smart W.



Smart W oblong chafing dish with glass lid

Material: Stainless steel 18-10; Tempered glass

Code: 15706-135

Size: L581 x W435 x H210 mm

Weight: 9.3 kg

Capacity: 8 Ltr (11101-070 food pan)
12 Ltr (11101-100 food pan)

Compatible with: 10 cm high pans



Smart W oblong chafing dish with S.S. lid

Material: Stainless steel 18-10

Code: 15707-135

Size: L581 x W435 x H213 mm

Weight: 8.9 kg

Capacity: 8 Ltr (11101-070 food pan)
12 Ltr (11101-100 food pan)

Compatible with: 10 cm high pans



Smart W oblong stand

Material: Stainless steel 18-10; Solid die casting legs; Silicone

Code: 11266-000

Size: L565 x W440 x H140 mm

Weight: 4.56 kg

Compatible with: 15706; 15707



Smart W square chafing dish with glass lid

Material: Stainless steel 18-10; Tempered glass

Code: 15700-CHOB

Size: L410 x W440 x H180 mm

Weight: 6.8 kg

Capacity: 5.5 Ltr



Smart W square chafing dish with S.S. lid

Material: Stainless steel 18-10

Code: 15703-CHOB

Size: L410 x W440 x H178 mm

Weight: 6.5 kg

Capacity: 5.5 Ltr



Smart W square chafing dish with S.S. lid bronze vintage

Material: Stainless steel 18-10; Bronze PVD coated Stainless steel; Solid die casting

Code: 15703-CHOB-BRZ

Size: L410 x W440 x H178 mm

Weight: 6.5 kg

Capacity: 5.5 Ltr



NEW

Smart W square stand

Material: Stainless steel 18-10; Solid die casting legs; Silicone

Code: 11265-000

Size: L405 x W455 x H140 mm

Weight: 3.7 kg

Compatible with: 15700; 15703



Smart W round chafing dish with glass lid

Material: Stainless steel 18-10; Tempered glass

Code: 15701-CHOB

Size: L440 x W490 x H195 mm

Weight: 6.8 kg

Capacity: 6 Ltr

Code: 15702-CHOB

Size: L380 x W435 x H180 mm

Weight: 5.5 kg

Capacity: 4.5 Ltr



Smart W round chafing dish with S.S. lid

Material: Stainless steel 18-10

Code: 15704-CHOB

Size: L440 x W490 x H215 mm

Weight: 6.4 kg

Capacity: 6 Ltr

Code: 15705-CHOB

Size: L380 x W435 x H175 mm

Weight: 5.3 kg

Capacity: 4.5 Ltr





Level adjustable foot.

Smart W round chafing dish with S.S. lid bronze vintage

Material: Stainless steel 18-10; Bronze PVD coated
Stainless steel; Solid die casting

Code: 15704 - CHOB-BRZ
Size: L440 × W490 × H215 mm
Weight: 6.4 kg
Capacity: 6 Ltr



NEW

Smart W round stand

Material: Stainless steel 18-10; Solid die casting legs;
Silicone

Code: 11263-000
Size: L350 × W440 × H140 mm
Weight: 3.6 kg
Compatible with: 15701; 15704

Code: 11264-000
Size: L300 × W420 × H140 mm
Weight: 3.5 kg
Compatible with: 15702; 15705; Soup Urn 16800







If storage space is a problem for you, the Smart W stackable stand is a smart choice.
STACKABLE UP TO 5.



Smart W stackable chafer stand (square)

Magnetic burner holder included.
Can be used with induction warmer 11762-230 and magnetic induction lid 11123-000.
Material: Stainless steel 18-10; Magnet; PE

Code: 11275-000
Size: L472 × W382.5 × H257 mm
Weight: 4.7 kg

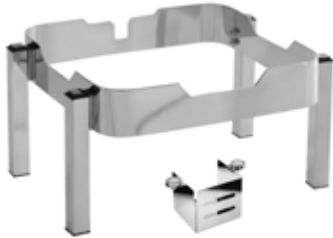

Smart W stackable chafer stand (oblong)

Magnetic burner holder included.
Can be used with induction warmer 11762-230 and magnetic induction lid 11123-000.
Material: Stainless steel 18-10; Magnet; PE

Code: 11274-000
Size: L648 × W381 × H268 mm
Weight: 5.6 kg

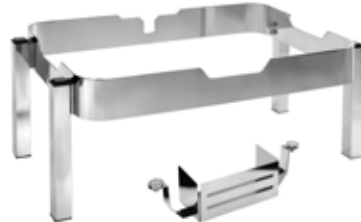

Smart W stackable chafer stand (round)

Magnetic burner holder included.
Can be used with induction warmer 11762-230 and magnetic induction lid 11123-000.
Material: Stainless steel 18-10; Magnet; PE

Code: 11276-000
Size: L514 × W514 × H247 mm
Weight: 4.5 kg
Compatible with: 15701; 15704

Code: 11277-000
Size: L456 × W456 × H247 mm
Weight: 4.3 kg
Compatible with: 15702; 15705



Smart W soup urn with glass lid (10 Ltr)

Material: Stainless steel 18-10; Tempered glass

Code: 16800-000
Size: L474 × W434 × H303 mm
Capacity: 10 Ltr
Weight: 7 kg
Compatible with: Smart W round stand 11264; Soup bucket K1-16800-230



Smart W spoon holder

Material: Stainless steel 18-10; Porcelain spoon not included

Code: 11272-000
Size: L150 × W131 × H87 mm
Weight: 0.22 kg



Smart W porcelain spoon holder

Material: Porcelain

Code: 11273-000
Size: L235 × W105 × H48 mm
Weight: 0.28 kg



SMART COLLECTION



Smart square chafing dish with stainless steel lid

Material: Stainless steel 18-10; Solid die casting handle
Back supporter and spoon holder hook not included.

Code: 15600-CHO; 15600-000 (drop-in)

Size: L453 x W407 x H200 mm

Weight: 6.8 kg; 6.6 kg (drop-in)

Capacity: 5.5 Ltr



Smart square chafing dish with glass lid

Material: Stainless steel 18-10; Solid die casting handle;
Tempered glass

Back supporter and spoon holder hook not included.

Code: 15601-CHO; 15601-000 (drop-in)

Size: L453 x W407 x H195 mm

Weight: 6.5 kg; 5.4 kg (drop-in)

Capacity: 5.5 Ltr



Smart round chafing dish with stainless steel lid

Material: Stainless steel 18-10; Solid die casting handle
Back supporter and spoon holder hook not included.

Code: 15300-CHO; 15300-000 (drop-in)

Size: L435 x W505 x H225 mm

Weight: 8.0 kg; 7.8 kg (drop-in)

Capacity: 6 Ltr



Smart round chafing dish with glass lid

Material: Stainless steel 18-10; Solid die casting handle;
Tempered glass
Back supporter and spoon holder hook not included.

Code: 15301-CHO; 15301-000 (drop-in)
Size: L435 × W505 × H202 mm
Weight: 8.4 kg; 8.2 kg (drop-in)
Capacity: 6 Ltr



Smart round chafing dish with stainless steel lid

Material: Stainless steel 18-10; Solid die casting handle
Back supporter and spoon holder hook not included.

Code: 15302-CHO; 15302-000 (drop-in)
Size: L378 × W442 × H193 mm
Weight: 5.5 kg; 5.3 kg (drop-in)
Capacity: 4.5 Ltr



Smart round chafing dish with glass lid

Material: Stainless steel 18-10; Solid die casting handle;
Tempered glass
Back supporter and spoon holder hook not included.

Code: 15303-CHO; 15303-000 (drop-in)
Size: L378 × W442 × H184 mm
Weight: 5.7 kg; 5.5 kg (drop-in)
Capacity: 4.5 Ltr



Smart round stand

Material: Stainless steel 18-10; Solid die casting handle;
Silicone

Code: 11259-000
Size: L410 × W295 × H150 mm
Weight: 3.38 kg
Compatible with: 15300; 15301

Code: 11260-000
Size: L375 × W265 × H150 mm
Weight: 3.28 kg
Compatible with: 15302; 15303



Smart square stand

Material: Stainless steel 18-10; Solid die casting handle;
Silicone

Code: 11261-000
Size: L415 × W353 × H150 mm
Weight: 3.48 kg
Compatible with: 15600; 15601



Smart serving spoon holder for smart round

Material: Stainless steel 18-10

Code: 11268-000
Size: L220 × W118 × H35 mm
Weight: 0.2 kg



Smart serving spoon holder for smart square

Material: Stainless steel 18-10

Code: 11269-000
Size: L240 × W110 × H35 mm
Weight: 0.22 kg





THE ARTISAN COLLECTION BY TIGER

The comfort of home served by professionals.



Square casting chafer with wood handle

Material: Al casting body; Tempered glass; Phenol; Ceramic Coated 18-10 S.S. food pan; Silicone
1 spoon included

Code: 15900-000
Size: L460 x W280 x H206 mm
Weight: 4.410 kg
Capacity: 4.5 Ltr



Square casting chafer with black handle

Material: Al casting body; Tempered glass; Phenol; Ceramic Coated 18-10 S.S. food pan; Silicone
1 spoon included

Code: 15900-001
Size: L460 x W280 x H206 mm
Weight: 4.410 kg
Capacity: 4.5 Ltr



Round casting chafer with wood handle

Material: Al casting body; Tempered glass; Phenol; Ceramic Coated 18-10 S.S. food pan; Silicone
1 spoon included

Code: 15901-000
Size: L449 x W330 x H209 mm
Weight: 4.330 kg
Capacity: 4.5 Ltr





Round casting chafer with black handle
 Material: Al casting body; Tempered glass; Phenol; Ceramic
 Coated 18-10 S.S. food pan; Silicone
 1 spoon included
Code: 15901-001
 Size: L449 × W330 × H209 mm
 Weight: 4.330 kg
 Capacity: 4.5 Ltr



Inductive bottom





Square casting chafer with wood handle
 Material: Al casting body; Tempered glass; Phenol;
 Stainless steel 18-10 Food pan; Silicone

Code: 15900-002
 Size: L460 × W280 × H206 mm
 Weight: 4.410 kg
 Capacity: 4.5 Ltr



NEW

Square casting chafer with black handle
 Material: Al casting body; Tempered glass; Phenol;
 Stainless steel 18-10 Food pan; Silicone

Code: 15900-003
 Size: L460 × W280 × H206 mm
 Weight: 4.410 kg
 Capacity: 4.5 Ltr



NEW

Round casting chafer with wood handle
 Material: Al casting body; Tempered glass; Phenol;
 Stainless steel 18-10 Food pan; Silicone

Code: 15901-002
 Size: L449 × W330 × H209 mm
 Weight: 4.330 kg
 Capacity: 4.5 Ltr



NEW

Round casting chafer with black handle
 Material: Al casting body; Tem-pered glass; Phenol;
 Stainless steel 18-10 Food pan; Silicone

Code: 15901-003
 Size: L449 × W330 × H209 mm
 Weight: 4.330 kg
 Capacity: 4.5 Ltr



NEW

Multi stand square black
 Material: Stainless steel 18-10; Powder coated steel
 (black); Silicone
 Compatible with mini induction and electric spring heater

Code: 19600-000-BLK
 Size: L360 × W360 × H174 mm
 Weight: 3.95 kg



NEW

Multi stand square bronze vintage
 Material: Stainless steel 18-10; Powder coated steel
 (bronze); Silicone
 Compatible with mini induction and electric spring heater

Code: 19600-000-BRZ
 Size: L360 × W360 × H174 mm
 Weight: 3.95 kg



NEW

Multi stand square black
 Material: Stainless steel 18-10; Powder coated steel (black)
 Compatible with electric spring heater, sterno and mini
 induction

Code: 19600-STN-BLK
 Size: L360 × W360 × H174 mm
 Weight: 3.95 kg



NEW



Ceramic coated stainless steel 18-10 food pan,
recommended wood or silicone spoon



Parked position



Home style design

Light aluminum casting body



INDUCTION HOB

When using any of Tigers induction chafers and combining them with Tigers Induction heaters you will accomplish many good things: going green, use less energy, run more chafers on a single power circuit, possibly eliminate the need to re-wire the building. Induction heaters require induction ready pans and chafers.



Anti skid silicone pad for induction.



Low consumption induction warmer!



Smart adaptor for built-in induction

Material: Stainless steel 18-10
Easy adaptor to transform to free standing induction hob.
Detachable back-supporter for Smart chafer.

Code: 11120-NEW
Size: L417 x W459 x H85 mm
Weight: 2.4 kg
Compatible with: 11758-230



Smart W oblong adaptor for built-in induction

Material: Stainless steel 18-10; Solid die casting
Easy adaptor to transform to free standing induction hob.
Detachable back-supporter for Smart chafer.

Code: 11120-OBL
Size: L458.5 x W576.5 x H84 mm
Weight: 3.4 kg
Compatible with: 11758-230



Smart induction hob with touch panel

Remote controller not included
Code: 11758-230
Rating: 230 V, 50/60 Hz, 1 KW (11758-230)
Size: L355 x W355 x H77 mm
Weight: 3.3 kg



Smart remote controller for induction 11758-230

Code: 11758-300
OPTIONAL



Remote controller for 11764

Code: 11764-300
OPTIONAL



Induction warmer (mini round, 300W)

Rating: 230V, 50/60Hz, 200~600W

Code: 11764-230
Size: D180 x H81.5 mm
Weight: 1.55 kg



Holds temperature at 300 Watts with Smart chafers.
Heat continuously for 4 hours non-stop
without connected control panel.

NEW

NEW

Magnetic fixing ring for 11762

Material: Stainless steel 18-10; Magnet

Code: 11123-000
Size: D268 x H19 mm
Weight: 1.6 kg



Anti skid silicone pad for induction

Material: Silicone

Code: 11759-000
Size: D263 x H2 mm
Weight: 0.1 kg





1. Removable lid opens at 90° and 180° degrees for serving versatility.



2. Dripless Waterpan.



3. Fully functional automatic slow-down system.



Roll top chafing dishes



Oblong Roll Top Chafing Dishes are made of solid 18-10 Stainless steel. The structure is sturdy due to 3 mm gauge frames. The lid opens to 90° and 180° for serving versatility and has an auto-braking system to prevent slamming. The lid will roll back to 90° and stop. To continue to 180° simply push the lid beyond the stop. This will help keep food warm more efficiently.

The water control system will decrease labor by recycling the condensation from the lid to the water pan. In addition, the lid can be removed for easy cleaning.

The handle keeps cool preventing burns.

The chafers are repairable, making this a quality investment that will last for years to come.

IBIS COLLECTION

If storage space is a problem for you, the Ibis Chafing Dish is a smart choice. The Ibis chafing dishes are stackable, so they require a fraction of the normal storage space when not in use. Thanks to its unique design, the Ibis Chafing Dish is cost effective. Ibis chafing dishes are stackable up to 5.



Ibis oblong roll top chafing dish

Material: Stainless steel 18-10; Solid die casting handle

Code: 17510-000

Size: L667 × W485 × H452 mm

Weight: 14 kg

Capacity: 8 Ltr



Ibis round roll top chafing dish

Material: Stainless steel 18-10; Solid die casting handle

Code: 17610-000 Large

Size: L515 × W518 × H470 mm

Weight: 11 kg

Capacity: 6 Ltr

Code: 17710-000 Medium

Size: L441 × W442 × H395 mm

Weight: 8 kg

Capacity: 4.5 Ltr



Ibis stacking trolley

Material: Powder coated steel pipe; Rubber carpet

Code: 91101-000

Size: L980 × W695 × H1546 mm

Weight: 30 kg



Ibis stacking trolley pvc cover

Material: PVC

Code: 91101-PVC

Size: L980 × W710 × H1400 mm (folded: H100 mm)



EURI COLLECTION



Euri oblong chafing dish with brass legs

Material: Stainless steel 18-10; Solid die casting handle and legs

Code: 1271D-B00

Size: L667 × W488 × H452 mm

Weight: 18.5 kg

Capacity: 8 Ltr



Euri round chafing dish with brass legs

Material: Stainless steel 18-10; Solid die casting handle and legs

Code: 1281D-B00

Size: L515 × W497 × H468 mm

Weight: 14.5 kg

Capacity: 6 Ltr



Euri round chafing dish with brass legs

Material: Stainless steel 18-10; Solid die casting handle and legs

Code: 1282D-B00

Size: L435 × W425 × H410 mm

Weight: 11.20 kg

Capacity: 4.5 Ltr



Euri oblong chafing dish with chrome legs

Material: Stainless steel 18-10; Solid die casting handle and legs

Code: 1271D-CHO

Size: L667 × W488 × H452 mm

Weight: 18.5 kg

Capacity: 8 Ltr



Euri round chafing dish with chrome legs

Material: Stainless steel 18-10; Solid die casting handle and legs

Code: 1281D-CHO

Size: L515 × W497 × H468 mm

Weight: 14.5 kg

Capacity: 6 Ltr



Euri round chafing dish with chrome legs

Material: Stainless steel 18-10; Solid die casting handle and legs

Code: 1282D-CHO

Size: L435 × W425 × H410 mm

Weight: 11.20 kg

Capacity: 4.5 Ltr



ODIN COLLECTION



Odin oblong chafing dish with brass legs

Material: Stainless steel 18-10; Solid die casting handle and legs

Code: 1231D-B00

Size: L667 × W498 × H452 mm

Weight: 19.5 kg

Capacity: 8 Ltr



Odin round chafing dish with brass legs

Material: Stainless steel 18-10; Solid die casting handle and legs

Code: 1241D-B00

Size: L515 × W523 × H468 mm

Weight: 15 kg

Capacity: 6 Ltr



Odin round chafing dish with brass legs

Material: Stainless steel 18-10; Solid die casting handle and legs

Code: 1242D-B00

Size: L435 × W445 × H410 mm

Weight: 14 kg

Capacity: 4.5 Ltr



Odin oblong chafing dish with chrome legs

Material: Stainless steel 18-10; Solid die casting handle and legs

Code: 1231D-CHO

Size: L667 × W498 × H452 mm

Weight: 19.5 kg

Capacity: 8 Ltr



Odin round chafing dish with chrome legs

Material: Stainless steel 18-10; Solid die casting handle and legs

Code: 1241D-CHO

Size: L515 × W523 × H468 mm

Weight: 15 kg

Capacity: 6 Ltr



Odin round chafing dish with chrome legs

Material: Stainless steel 18-10; Solid die casting handle and legs

Code: 1242D-CHO

Size: L435 × W445 × H410 mm

Weight: 14 kg

Capacity: 4.5 Ltr



Odin oblong chafing dish drop-in

Material: Stainless steel 18-10; Solid die casting handle

Code: 1434D-000

Size: L667 × W475 × H410 mm

Weight: 12.80 kg

Capacity: 8 Ltr



Odin round chafing dish drop-in

Material: Stainless steel 18-10; Solid die casting handle

Code: 1444D-000

Size: L515 × W485 × H470 mm

Weight: 10.20 kg

Capacity: 6 Ltr



CONTEMPORARY COLLECTION



Contemporary oblong chafing dish

Material: Stainless steel 18-10

Code: 15410-000

Size: L650 x W415 x H440 mm

Weight: 11.7 kg

Capacity: 8 Ltr



WARM



Contemporary round chafing dish

Material: Stainless steel 18-10

Code: 15420-000

Size: L495 x W485 x H480 mm

Weight: 6.6 kg

Capacity: 6 Ltr



WARM



ELECTRIC HEATERS

Equipped with temperature sensor which can detect accurate temperature. Delay function to set the time of use. Overheating alarm system.



Spring electric heater with digital controller and temperature sensor

Material: Stainless steel frame; Aluminium sheathed; Ceramic coated die casting plate; PPS

Code: 11731-UGD
 Rating: 230V, 50/60Hz, 400W
 Size: L110 × W180 × H123 mm
 Weight: 1.2 kg



Universal electric roll top chafing dish heater plate with digital controller and temperature sensor

Material: Aluminium sheathed; Ceramic coated die casting plate; PPS
 Compatible with: oblong and round roll top chafing dishes

Code: 11722-000
 Rating: 230V, 50/60Hz, 470W
 Size: L200 × W235 × H37 mm
 Weight: 1.48 kg



Universal Electric Heater Plate with digital controller and temperature sensor + round water pan (dripless).



MINI CHAFER COLLECTION



Odin mini sauce chafing dish with brass legs

Material: Stainless steel 18-10; Porcelain

Code: 12920-B00

Package: Porcelain tray included

Size: L235 x W235 x H310 mm

Weight: 4.2 kg

Capacity: 0.8 Ltr



Odin mini sauce chafing dish with chrome legs

Material: Stainless steel 18-10; Porcelain

Code: 12920-CHO

Package: Porcelain tray included

Size: L235 x W235 x H310 mm

Weight: 4.2 kg

Capacity: 0.8 Ltr



Mini chafing dish

Material: Stainless steel 18-10; Chrome plated brass pipe; Porcelain

Code: 12910-CHO

Package: Porcelain tray included

Size: L270 x W270 x H310 mm

Weight: 3.2 kg

Capacity: 0.8 Ltr



Domino sauce chafing dish

Material: Stainless steel 18-10; Porcelain; Corian

Package: Porcelain tray included

Code: 19401-180

Size: L250 x W250 x H312 mm

Weight: 5.56 kg

Capacity: 0.8 Ltr



Tiffany mini sauce chafer

Material: Stainless steel 18-10; Solid die casting handle; Porcelain

Code: 12921-000

Size: L227 x W224 x H323 mm

Weight: 2.7 kg

Capacity: 0.8 Ltr



Tiffani mini sauce chafer golden bell

Material: Stainless steel 18-10; Solid die casting handle; Rose gold PVD coated stainless steel dome cover; Porcelain

Code: 12921-001

Size: L224 x W224 x H494 mm

Weight: 2.65 kg

Capacity: 0.8 Ltr



Tiffani mini sauce chafer golden bell bronze vintage

Material: Stainless steel 18-10; Solid die casting handle; Bronze PVD coated stainless steel dome cover; Porcelain

Code: 12921-001-BRZ

Size: L224 x W224 x H494 mm

Weight: 2.65 kg

Capacity: 0.8 Ltr



NEW



Chafing dishes accessories



ACCESSORIES

HOW TO MAKE SOUP STATION

With Tiger chafers, conventional chafers can transform into soup station as easy as ABC. Simply take out the food pan and insert the kit as indicated below.

1. Soup kit for round Induction chafing dish:
11228 (large) + 11500 (1 ea)
11238 (medium) + 11500 (1 ea)
2. Soup kit for round roll top chafing dish:
11228 (large) + 11500 (1 ea)
11238 (medium) + 11500 (1 ea)
3. Soup kit for oblong roll top chafing dish:
11118 + 11500 (2 ea)



Soup bucket with single wall

Material: Stainless steel 18-10

Code: 11500-000

Size: D240 x H214 mm

Weight: 0.92 kg

Capacity: 4.2 Ltr



Round soup station lid

Material: Stainless steel 18-10

Code: 11228-000

Size: D390 x H55 mm

Weight: 0.82 kg

Thickness: 1 mm



Round soup station lid

Material: Stainless steel 18-10

Code: 11238-000

Size: D328 x H60 mm

Weight: 0.7 kg

Thickness: 1 mm



Oblong soup station lid

Material: Stainless steel 18-10











Code: 11118-000

Size: L537 x W335 x H56 mm















Weight: 1.14 kg

Thickness: 1 mm

















<p>Fuel holder cup Material: Stainless steel 18-10 Code: 11900-000 Size: L93 x W169.5 x H65.8 mm Weight: 0.12 kg</p> 	<p>Hinged soup bucket (4.2 Ltr) Material: Stainless steel 18-10 Code: 11500-500 Size: L237 x W254 x H209 mm Weight: 1.03 kg Capacity: 4.2 Ltr</p>  <p>HINGED</p>	<p>Soup bucket for 16500 (10 Ltr) Material: Stainless steel 18-10 Code: S1-16500-200 Size: L360 x W315 x H350 mm Weight: 1.95 kg Capacity: 10 Ltr</p> 	<p>Soup Bucket for 16800 (10 ltr) Material: Stainless steel 18-10 Code: K1-16800-230 Size: D287.9 x H210.7 mm Weight: 0.9 kg Capacity: 10 Ltr</p> 
<p>Smart serving spoon holder for smart round Material: Stainless steel 18-10 Code: 11268-000 Size: L220 x W118 x H35 mm Weight: 0.2 kg</p> 	<p>Smart serving spoon holder for smart square Material: Stainless steel 18-10 Code: 11269-000 Size: L240 x W110 x H35 mm Weight: 0.22 kg</p> 	<p>Detachable serving spoon holder for oblong roll top chafer Material: Stainless steel 18-10 Code: 11270-000 Size: L235 x W108 x H104 mm Weight: 0.26 kg Spoon not included</p> 	<p>Detachable serving spoon holder for round roll top chafer Material: Stainless steel 18-10 Code: 11271-000 Size: L220 x W116 x H104 mm Weight: 0.24 kg</p> 
<p>Smart W spoon holder Material: Stainless steel 18-10; Porcelain Code: 11272-000 Size: L150 x W131 x H87 mm Weight: 0.22 kg Spoon not included</p> 	<p>Smart W porcelain spoon holder Material: Porcelain Code: 11273-000 Size: L235 x W105 x H48 mm Weight: 0.28 kg</p> 	<p>Windguard round Material: Stainless steel 18-10 Code: 11914-000 Size: L140 x W120 x H77 mm Weight: 0.38 kg</p> 	<p>Windguard oblong Material: Stainless steel 18-10 Code: 11913-000 Size: L370 x W120 x H77 mm Weight: 0.6 kg</p> 











<p>Yogurt lid (28 holes) Material: Stainless steel 18-10 Code: 11512-000 Size: L480 × W287 × H10 mm Weight: 1.04 kg Package: 3 ea/set</p> 	<p>Ice pack Material: HDPE cylinder Code: 11511-000 Package: 2 ea Size: L255 × W200 × H30 mm Weight: 1 kg</p>  <p> COOL</p>	<p>Ice pack tray Material: Stainless steel 18-10 Code: 11513-ST5 Size: L495 × W300 × H55 mm Weight: 1.22 kg Capacity: 5 Ltr Thicknes: 1 mm</p>  <p> COOL</p>	<p>Adaptor ring for 10 cm depth food pan Material: Stainless steel 18-10 Code: 11119-000 Size: L460 × W410 × H80 mm Weight: 1.66 kg Thicknes: 1 mm</p> 
<p>Oblong food pan (GN 1/1) Material: Stainless steel 18-10 Code: 11101-070 Size: L530 × W325 × H65.5 mm Weight: 1.54 kg Capacity: 8 Ltr Thicknes: 1 mm</p> 	<p>Oblong food pan (GN 1/2, 1 ea) Material: Stainless steel 18-10 Code: 11102-000 Size: L265 × W325 × H65 mm Weight: 0.74 kg Capacity: 4 Ltr Thicknes: 0.7 mm</p> 	<p>Oblong food pan (GN 1/3, 1 ea) Material: Stainless steel 18-10 Code: 11103-000 Size: L176 × W325 × H65 mm Weight: 0.46 kg Capacity: 2.5 Ltr Thicknes: 0.7 mm</p> 	<p>Drip dish for 11103 Material: Stainless steel 18-10 Code: 11516-000 Size: L127 × W259 × H19.5 mm Weight: 0.35 kg (1 ea)</p> 
<p>Round food pan (large) Material: Stainless steel 18-10 Code: 11201-000 Size: D383 × H66 mm Weight: 1.28 kg Capacity: 6 Ltr Thicknes: 1 mm</p> 	<p>Round food pan (medium) Material: Stainless steel 18-10 Code: 11202-000 Size: D328 × H66 mm Weight: 0.98 kg Capacity: 4.5 Ltr Thicknes: 1 mm</p> 	<p>Round half food pan Material: Stainless steel 18-10 Code: 11221-HLF Package: 2 pcs/set Size: D385 × H68 mm Weight: 1.06 kg (1 ea) Capacity: 2.7 Ltr (1 ea) Thicknes: 1.2 mm</p> 	<p>Drip dish for 11221-HLF Material: Stainless steel 18-10 Code: 11517-000 Size: L140.5 × W314 × H25 mm Weight: 0.36 kg (1 ea)</p> 



<p>Oblong food pan (GN 2/3) Material: Stainless steel 18-10</p> <p>Code: 11104-000 Size: L335 × W325 × H65.5 mm Weight: 1.12 kg Capacity: 5.5 Ltr Thicknes: 1 mm</p> 	<p>Oblong food pan (GN 2/3) Material: Stainless steel 18-10</p> <p>Code: 11104-100 Size: L351 × W324 × H100 mm Weight: 0.75 kg Capacity: 8.5 Ltr Thicknes: 1 mm</p>  <p style="text-align: center;">NEW</p>	<p>Oblong S.S. food pan for Artisan (4.5Ltr) Material: Stainless steel 18-10</p> <p>Code: 11318-000 Size: L340 × W280 × H65 mm Weight: 0.95 kg Capacity: 4.5 Ltr Thicknes: 1 mm</p>  <p style="text-align: center;">NEW</p>	<p>Oblong food pan (GN 1/1) Material: Stainless steel 18-10</p> <p>Code: 11101-100 Size: L530 × W325 × H100 mm Weight: 1.80 kg Capacity: 12 Ltr Thicknes: 1 mm</p> 
<p>Oblong Water Pan (non-dripless) Material: Stainless steel 18-10</p> <p>Code: 11300-001 Size: L534 × W329 × H101 mm Weight: 1.94 kg Capacity: 15 Ltr Thicknes: 1 mm</p>  	<p>Round water pan (non-dripless) Material: Stainless steel 18-10</p> <p>Code: 11401-000 Size: D382 × H100 mm Weight: 1.52 kg Capacity: 10 Ltr Thicknes: 1 mm</p>  	<p>Round water pan (non-dripless) Material: Stainless steel 18-10</p> <p>Code: 11402-000 Size: D325 × H88.5 mm Weight: 1.22 kg Capacity: 6 Ltr Thicknes: 1 mm</p>  	<p>Round water pan (dripless) Material: Stainless steel 18-10</p> <p>Code: 11401-200 Size: L452 × W428 × H95 mm Weight: 1.74 kg Capacity: 9 Ltr Thicknes: 1 mm</p>  
<p>Oblong water pan (dripless) Material: Stainless steel 18-10</p> <p>Code: 11307-000 Size: L604 × W307 × H103 mm Weight: 2.25 kg Capacity: 14 Ltr Thicknes: 1 mm</p>  			























<p>Porcelain insert round (1/1) Material: Porcelain Code: 11204-000 Package: 3 ea/set Size: D388 × H66 mm Weight: 2.44 kg Capacity: 5 Ltr</p> 	<p>Porcelain insert round (1/1) Material: Porcelain Code: 11214-000 Package: 3 ea/set Size: D328 × H71 mm Weight: 2 kg Capacity: 3.5 Ltr</p> 	<p>Porcelain insert round (1/2) Material: Porcelain Code: 11205-000 Package: 3 ea/set Size: D388 × H66 mm Weight: 2.98 kg Capacity: 4 Ltr</p> 	<p>Porcelain insert round (1/2) Material: Porcelain Code: 11215-000 Package: 3 ea/set Size: D328 × H71 mm Weight: 1.96 kg Capacity: 2.6 Ltr</p> 
<p>Round divided porcelain insert (1/3) Material: Porcelain Code: 11217-000 Size: D388 × H66 mm Weight: 3.3 kg Capacity: 3 Ltr</p> 	<p>Porcelain insert (GN 1/1) Material: Porcelain Code: 11206-000 Package: 2 ea Size: L534 × W329 × H63 mm Weight: 5.1 kg Capacity: 7 Ltr</p> 	<p>Porcelain insert (GN 1/1) Material: Porcelain Code: 11206-250 Package: 3 ea Size: L500 × W306 × H33 mm Weight: 2.52 kg</p> 	<p>Porcelain insert (GN 1/2) Material: Porcelain Code: 11207-000 Package: 3 ea Size: L329 × W267 × H63 mm Weight: 3.6 kg Capacity: 4 Ltr</p> 
<p>Porcelain insert (GN 1/2) Material: Porcelain Code: 11207-250 Package: 3 ea Size: L252 × W306 × H33 mm Weight: 1.34 kg</p> 	<p>Porcelain insert (GN 1/3) Material: Porcelain Code: 11208-000 Package: 3 ea Size: L178 × W329 × H63 mm Weight: 1.8 kg Capacity: 2 Ltr</p> 	<p>Porcelain insert (GN 2/3) Material: Porcelain Code: 11209-209 Package: 3 ea Size: L329 × W355 × H63 mm Weight: 2.6 kg Capacity: 3 Ltr</p> 	<p>Mini chafer insert Material: Porcelain Code: 11216-000 Package: 3 ea Size: D208 × H60 mm Weight: 0.6 kg Capacity: 0.8 Ltr</p> 

CERAMIC COATED S.S. FOOD PANS

Unbreakable beauty!











1. Ceramic coated Stainless Steel food pan
2. Dish-washer safe
3. Compatible food pans for all the chafers



<p>Ceramic coated S.S. 18-10 oblong food pan (GN 1/1, 65 mm) Material: Stainless steel 18-10; Ceramic coated Code: 11310-WHT Size: L530 × W325 × H65.5 mm Weight: 1.65 kg Capacity: 8 Ltr</p>  	<p>Ceramic coated S.S. 18-10 oblong food pan (GN 1/1, 100 mm) Material: Stainless steel 18-10; Ceramic coated Code: 11311-WHT Size: L534 × W329 × H101 mm Thickness: 0.7 mm Weight: 1.45 kg Capacity: 15 Ltr</p>  	<p>Ceramic coated S.S. 18-10 oblong food pan (GN 1/2, 65 mm) Material: Stainless steel 18-10; Ceramic coated Code: 11312-WHT Size: L265 × W325 × H65 mm Weight: 0.65 kg Capacity: 4 Ltr</p>  	<p>Ceramic coated S.S. 18-10 oblong food pan (GN 1/3, 65 mm) Material: Stainless steel 18-10; Ceramic coated Code: 11313-WHT Size: L176 × W325 × H65 mm Weight: 0.5 kg Capacity: 4 Ltr</p>  
<p>Ceramic coated S.S. 18-10 oblong food pan (GN 2/3, 65 mm) Material: Stainless steel 18-10; Ceramic coated Code: 11314-WHT Size: L355 × W325 × H65.5 mm Weight: 1.15 kg Capacity: 5.5 Ltr</p>  	<p>Ceramic coated S.S. 18-10 round food pan (6 Ltr) Material: Stainless steel 18-10; Ceramic coated Code: 11315-WHT Size: D383 × H66 mm Weight: 1.25 kg Capacity: 6 Ltr</p>  	<p>Ceramic coated S.S. 18-10 round food pan (4.5 Ltr) Material: Stainless steel 18-10; Ceramic coated Code: 11316-WHT Size: D328 × H66 mm Weight: 0.95 kg Capacity: 4.5 Ltr</p>  	<p>Ceramic coated S.S. 18-10 round half food pan (2.7 Ltr) Material: Stainless steel 18-10; Ceramic coated Code: 11317-WHT Size: D385 × H68 mm Weight: 0.85 kg Capacity: 2.7 Ltr</p>  
<p>Ceramic coated S.S. 18-10 casting chafer food pan (GN 2/3) Material: Stainless steel 18-10; Ceramic coated Code: 11318-WHT Size: L340 × W280 × H65 mm Thickness: 1 mm Weight: 0.95 kg Capacity: 4.5 Ltr</p>  	<p>Silicone Serving Spoon Material: Silicone; Nylon Code: 11524-SET Package: 6 ea/set Size: L340.5 × W65.5 × H26.5 mm Weight: 0.15 kg (1 ea)</p>  <p>NEW</p>		

SERVING SPOONS



<p>Shelly tong Material: Stainless steel 18-8 Code: 11506-000 Package: 6 ea/set Size: H250 mm Weight: 0.3 kg</p> 	<p>9.5" Spring tong Material: Stainless steel 18-8 Code: 11507-000 Package: 6 ea/set Size: H245 mm Weight: 0.22 kg</p> 	<p>Spaghetti tong Material: Stainless steel 18-8 Code: 11508-000 Package: 6 ea/set Size: H190 mm Weight: 0.16 kg</p> 	<p>Multi use tong Material: Stainless steel 18-10 Code: 11008-000 Size: L82 x W46 x H250 mm Weight: 0.13 kg</p> 
<p>Soup ladle Material: Stainless steel 18-8 Code: 11501-000 Package: 6 ea/set Size: H305 mm Weight: 0.22 kg</p> 	<p>Solid spoon Material: Stainless steel 18-8 Code: 11502-000 Package: 6 ea/set Size: H345 mm Weight: 0.25 kg</p> 	<p>Slotted spoon Material: Stainless steel 18-8 Code: 11503-000 Package: 6 ea/set Size: H345 mm Weight: 0.24 kg</p> 	<p>Meat fork Material: Stainless steel 18-8 Code: 11504 Package: 6 ea/set Size: H355 mm Weight: 0.22 kg</p> 
<p>Pasta ladle Material: Stainless steel 18-8 Code: 11505-000 Package: 6 ea/set Size: H350 mm Weight: 0.3 kg</p> 	<p>Soup ladle Material: Stainless steel 18-8 Code: 11523-000 Package: 6 ea/set Size: L90 x H310 mm Weight: 0.192 kg (1 ea)</p> 	<p>Cake server Material: Stainless steel 18-8 Code: 11522-000 Package: 6 ea/set Size: L53 x H246 mm Weight: 0.108 kg (1 ea)</p> 	<p>Silicone Serving Spoon Material: Silicone; Nylon Code: 11524-SET Package: 6 ea/set Size: L340.5 x W65.5 x H26.5 mm Weight: 0.15 kg (1 ea)</p> 

NEW



Urns and dispensers



The cereal dispenser is designed to dispense many different dry foods such as: Nuts, goldfish, trail mix, candy, yogurt toppings and of course cereal. Simply turn the soft rubber paddle with the handle to dispense. There is a catch tray at the bottom for crumbs. It can be easily assembled and disassembled so its simple to clean and repair. Replacement parts are readily available. This makes it a quality investment that will last for years to come. Made of 18-10 Stainless steel. The Dispenser cylinders are made of polycarbonate. Dishwasher safe. Outstanding scratch resistance and no glazing. Bisphenol A (BPA) Free. Juice Dispenser has a removable stainless steel ice core that fits onto the edge of the acrylic jar. The interior ridge of the acrylic jar flares, making the jar stronger. It has a removable drip tray for easy cleaning. Replacement parts are also available, so the juice dispenser is 100% repairable.

Coffee urns are designed to look great and be simple and easy to clean or service. With our optional electric heater, you can keep the coffee at a perfect temperature without it burning or scorching. It's made out of 18/10 stainless steel & comes with an insulated lid.

SMART W SOUP URNS

This 10 Liter capacity of soup urn is equipped with clad bottom, which works on the induction hob with 98% of responsiveness. With the stand, heating methods becomes even more versatile. Like any of our induction chafers, sterno or electric spring heater (11731-DGT) can be used.

Everlasting hydraulic hinge enables the one-hand operation to serve the food while keeping the soup warm and moisture. Modern and fun design of Smart W ranges has been completed with the arrival of soup urn.



Smart W soup urn with glass lid (10 Ltr)

Material: Stainless steel 18-10; Tempered glass

Code: 16800-000

Size: L474 x W434 x H303 mm

Capacity: 10 Ltr

Weight: 7 kg

Compatible with: Smart W round stand 11264; Soup bucket K1-16800-230



ODIN SOUP AND COFFEE URNS



Odin coffee urn (3 gal) with brass legs
Material: Stainless steel 18-10; Solid die casting handle and Legs

Code: 16330-B00
Size: L315 x W315 x H575 mm
Weight: 7.6 kg
Capacity: 12 Ltr



Odin coffee urn (3 gal) with chrome legs
Material: Stainless steel 18-10; Solid die casting handle and Legs

Code: 16330-CHO
Size: L315 x W315 x H575 mm
Weight: 7.6 kg
Capacity: 12 Ltr



Odin coffee urn (5 gal) with brass legs
Material: Stainless steel 18-10; Solid die casting handle and legs

Code: 16350-B00
Size: L325 x W325 x H690 mm
Weight: 8.3 kg
Capacity: 19 Ltr



Odin coffee urn (5 gal) with chrome legs
Material: Stainless steel 18-10; Solid die casting handle and legs

Code: 16350-CHO
Size: L325 x W325 x H690 mm
Weight: 8.3 kg
Capacity: 19 Ltr



EURI COFFEE URNS



Euri coffee urn (3 gal) with brass legs

Material: Stainless steel 18-10

Code: 16360-B00

Size: L315 x W315 x H575 mm

Weight: 7.6 kg

Capacity: 12 Ltr



WARM



Euri coffee urn (3 gal) with chrome legs

Material: Stainless steel 18-10

Code: 16360-CHO

Size: L315 x W315 x H575 mm

Weight: 7.6 kg

Capacity: 12 Ltr



WARM



Euri coffee urn (5 gal) with brass legs

Material: Stainless steel 18-10

Code: 16370-B00

Size: L320 x W320 x H690 mm

Weight: 8.3 kg

Capacity: 19 Ltr



WARM



Euri coffee urn (5 gal) with chrome legs

Material: Stainless steel 18-10

Code: 16370-CHO

Size: L320 x W320 x H690 mm

Weight: 8.3 kg

Capacity: 19 Ltr



WARM



IBIS COFFEE URNS



Ibis coffee urn (1 gal)

Material: Stainless steel 18-10

Code: 16340-000

Size: L228.6 × W266 × H388 mm

Weight: 3.17 kg

Capacity: 4.5 Ltr



WARM



DISPENSER SETS



Borosilicate glass juice set (3 cylinder)

Material: Borosilicate glass; Stainless steel 18-10; PMMA (Acrylic); ABS (chrome plated); Silicone

Code: 40021-000

Size: L505 x W176 x H337 mm

Weight: 3.38 kg

Capacity: 1.2 Ltr (1 cylinder)



Borosilicate glass cereal set (3 cylinder)

Material: Glass, Stainless steel 18-10; PMMA (Acrylic); ABS (chrome plated); Silicone

Code: 40022-000

Size: L505 x W176 x H337 mm

Weight: 3.38 kg

Capacity: 1.2 Ltr (1 cylinder)





Borosilicate glass juice set (3 cylinder)

Material: Borosilicate glass; Asy wood; ABS (chrome plated); Silicone

Code: 40021-ASH

Size: L414 × W158 × H340.5 mm

Weight: 2.55 kg

Capacity: 1.2 Ltr (1 cylinder)



Borosilicate glass cereal set (3 cylinder)

Material: Borosilicate glass; Asy wood; ABS (chrome plated); Silicone

Code: 40022-ASH

Size: L414 × W158 × H340.5 mm

Weight: 2.55 kg

Capacity: 1.2 Ltr (1 cylinder)



T-COLLECTION DISPENSERS







T-Collection glass container juice dispenser (single)

Material: Stainless steel 18-10; Powder coated steel pipe (black); Asy wood (gray); Tempered glass; Silicone
Ice core included

Code: 18005-000
Size: L287.5 x W296.2 x H523
Weight: 5.15 kg
Capacity: 5.7 Ltr



NEW

T-Collection glass container juice dispenser (double)

Material: Stainless steel 18-10; Powder coated steel pipe (black); Asy wood (gray); Tempered glass; Silicone
Ice core included

Code: 18006-000
Size: L574.5 x W296.2 x H523
Weight: 9.88 kg
Capacity: 11.4 Ltr



NEW

Acrylic diffuser core

Material: PMMA (Acrylic), Silicone

Code: 18005-200
Size: D130 x H270 mm
Weight: 0.31 kg
Capacity: 0.7 Ltr
Diffuser optional



Acrylic ice core

Material: PMMA (Acrylic), Silicone

Code: 18005-100
Size: D130 x H270 mm
Weight: 0.33 kg
Capacity: 0.7 Ltr
Spare part



T-Collection cereal dispenser

Material: Stainless steel 18-10; Powder coated steel; Ashwood; PP; Silicone; POM; Solid die casting
Ice core included

Code: 18430-000
Size: L160 x W216.8 x H632.8
Weight: 5.4 kg
Capacity: 3 Ltr



T-Collection cereal dispenser container

Material: Ashwood; Chestnut wood; PMMA (Acrylic); Powder coated steel pipe(black)

Code: 18007-000
Size: L530.5 x W162.5 x H278 mm
Weight: 3.95 kg
Capacity: 2 Ltr x 3ea (6 Ltr)



T-Collection cereal container with cover

Material: Ashwood

Code: 18007-100
Size: L130 x W130 x H125 mm



T-Collection cereal dispenser stand

Material: Ashwood; Powder coated steel pipe(black)

Code: 18007-200
Size: L530.5 x W162.5 x H120 mm
Weight: 1.5 kg



T-Collection cereal dispenser spoon

Material: Wood

Code: 18007-300
Size: L63 x H220 mm
Weight: 0.04 kg





T-Collection square juice dispenser 7 Ltr

Material: Stainless steel 18-10; Powder coated steel pipe(black); PMMA (Acrylic); Silicone

Code: 18008-000

Size: L286.5 x W392.3 x H399 mm

Weight: 5.55 kg

Capacity: 7 Ltr



NEW

T-Collection square juice dispenser 15 Ltr

Material: Stainless steel 18-10; Powder coated steel pipe(black); PMMA (Acrylic); Silicone

Code: 18009-000

Size: L286.5 x W392.3 x H661 mm

Weight: 8.05 kg

Capacity: 15 Ltr



NEW

Universal drip tray for juice dispenser

Material: Stainless steel 18-10; Silicone

Code: 18008-300

Size: L107.9 x W107.9 x H16.5 mm

Weight: 0.35 kg



NEW

Ice core for 18008-000

Material: PMMA (Acrylic)

Code: 18008-100

Size: L70 x W90 x H172 mm

Weight: 0.19 kg

Capacity: 0.67 Ltr



NEW

Diffuser for 18008-000

Material: PMMA (Acrylic)

Code: 18008-200

Size: L70 x W90 x H172 mm

Weight: 0.18 kg

Capacity: 0.67 Ltr



NEW

Ice core for 18009-000

Material: PMMA (Acrylic)

Code: 18009-100

Size: L70 x W90 x H400 mm

Weight: 0.39 kg

Capacity: 1.6 Ltr



NEW

Diffuser for 18009-000

Material: PMMA (Acrylic)

Code: 18009-200

Size: L70 x W90 x H400 mm

Weight: 0.37 kg

Capacity: 1.6 Ltr



NEW

T-Collection cereal dispenser bronze vintage

Material: Stainless steel 18-10; Powder coated steel (black); Asy wood; PP; Silicone; POM; Solid die casting; Bronze PVD coated

Code: 18430-000-BRZ

Size: L160 x W216.8 x H632.8

Weight: 5.4 kg

Capacity: 3 Ltr



NEW

HI-LINE DISPENSERS



Hi-line milk dispenser

Material: Stainless steel 18-10; PMMA (Acrylic) stand

Code: 18921-IWS

Size: L375 x W235 x H480 mm

Weight: 4.5 kg

Capacity: 5 Ltr



COOL



Hi-line juice dispenser

Material: Stainless steel 18-10; Polycarbonate cylinder; PMMA (Acrylic) stand

Code: 18912-IWS

Size: L375 x W210 x H620 mm

Weight: 5 kg

Capacity: 7 Ltr



COOL



Hi-line cereal dispenser

Material: Stainless steel 18-10; Polycarbonate cylinder; PMMA (Acrylic) stand

Code: 18913-IWS

Size: L220 x W210 x H610 mm

Weight: 2 kg

Capacity: 3.7 Ltr



COOL



EURI DISPENSERS



Euri juice dispenser (1.8 gal) with brass legs

Material: Stainless steel 18-10; Polycarbonate cylinder;
Solid die casting

Code: 18610-B00

Size: L285 x W285 x H590 mm

Weight: 6.5 kg

Capacity: 7 Ltr



Euri juice dispenser (1.8 gal) with chrome legs

Material: Stainless steel 18-10; Polycarbonate cylinder; Solid
die casting

Code: 18610-CHO

Size: L285 x W285 x H590 mm

Weight: 6.5 kg

Capacity: 7 Ltr



ODIN DISPENSERS



Odin juice dispenser (1.8 gal)

Material: Stainless steel 18-10; Polycarbonate cylinder; Solid die casting base

Code: 18001-000

Size: L325 x W195 x H560 mm

Weight: 5 kg

Capacity: 7 Ltr



Odin juice dispenser (1 gal)

Material: Stainless steel 18-10; Polycarbonate cylinder; Solid die casting base

Code: 18003-000

Size: L325 x W200 x H460 mm

Weight: 4.3 kg

Capacity: 3.7 Ltr



Odin milk dispenser

Material: Stainless steel 18-10; Solid die casting base

Code: 18710-000

Size: L325 x W200 x H430 mm

Weight: 4.6 kg

Capacity: 5 Ltr





Odin cereal dispenser (single)

Material: Stainless steel 18-10; Polycarbonate cylinder;
Solid die casting base

Code: 18310-000

Size: L265 × W200 × H595 mm

Weight: 3.3 kg

Capacity: 3.7 Ltr



Odin cereal dispenser (double)

Material: Stainless steel 18-10; Polycarbonate cylinder;
Solid die casting base

Code: 18410-000

Size: L215 × W310 × H595 mm

Weight: 5.2 kg

Capacity: 3.7 Ltr (1 ea)



Odin cereal dispenser (triple)

Material: Stainless steel 18-10; Polycarbonate cylinder;
Solid die casting base

Code: 18420-000

Size: L265 × W265 × H595 mm

Weight: 6.7 kg

Capacity: 3.7 Ltr (1 ea)







WOOD COLLECTION DISPENSERS



Juice dispenser with wooden base
Material: Wood; 18-10 S.S.; Polycarbonate cylinder
Code: 19403-NAT (natural)
Size: L344 x W223 x H490 mm
Capacity: 3.8 Ltr



Juice dispenser with wooden base
Material: Wood; 18-10 S.S.; Polycarbonate cylinder
Code: 19403-NOC (walnut)
Size: L344 x W223 x H490 mm
Capacity: 3.8 Ltr



Juice dispenser with wooden base
Material: Wood; 18-10 S.S.; Polycarbonate cylinder
Code: 19403-NER (black)
Size: L344 x W223 x H490 mm
Capacity: 3.8 Ltr





Milk dispenser with wooden base

Material: Wood; 18-10 S.S

Code: 18710-NAT (natural)

Size: L335 x W192 x H460 mm

Capacity: 5 Ltr



Milk dispenser with wooden base

Material: Wood; 18-10 S.S

Code: 18710-NOC (walnut)

Size: L335 x W192 x H460 mm

Capacity: 5 Ltr



Milk dispenser with wooden base

Material: Wood; 18-10 S.S

Code: 18710-NER (black)

Size: L335 x W192 x H460 mm

Capacity: 5 Ltr





Buffet presentation



Tiger's new hollow ware and small ware are exclusively born from craftsmanship of Italian design master Giuliano Malimpensa. He has been designing and manufacturing Interior objects and retail items for over 40 years and has won worldwide recognition for his unique work. The synergy between his design experience and Tiger's diligent manufacturing has created practical professional products with a touch of elegance and class.

Tiger guarantees the premium quality with selection of high quality material and its products comply with the strictest European and American standards.





STANDS AND RISERS



Three nesting risers to save space and to provide elegant elevation.



T-Collection steel riser (1 tier)
Material: Powder coated steel pipe (black)
Code: 19940-001
Size: L325 x W265 x H103 mm
Weight: 0.87 kg



T-Collection steel riser (inclined)
Material: Powder coated steel pipe (black)
Code: 19940-002
Size: L325 x W265 x H197 mm
Weight: 0.96 kg



T-Collection steel riser (2 tiers)
Material: Powder coated steel pipe (black)
Code: 19940-003
Size: L355 x W265 x H253 mm
Weight: 1.11 kg



T-Collection steel riser (3 tiers)
Material: Powder coated steel pipe (black)
Code: 19940-004
Size: L385 x W265 x H403 mm
Weight: 1.25 kg



T-Collection steel riser (3 tiers set)
Material: Powder coated steel pipe (black)
Code: 19940-005
Size: L385 x W265 x H403 mm
Weight: 3.24 kg



T-Collection ice white Lucite tray
Material: PMMA (Acrylic)
Code: 19119-000
Size: L325 x W265 x H75 mm
Weight: 1.79 kg



T-Collection gray ash wood tray
Material: Ashwood
Code: 19117-400
Size: L325 x W265 x H40 mm
Weight: 0.56 kg



STACKABLE



T-Collection gray ash wood tray
Material: Ashwood
Code: 19117-750
Size: L325 x W265 x H75 mm
Weight: 0.68 kg



STACKABLE





T-Collection steel riser bronze vintage (1 tier)
Material: Powder coated steel pipe (bronze)

Code: 19940-001-BRZ
Size: L325 x W265 x H103 mm
Weight: 0.87 kg



NEW

T-Collection steel riser bronze vintage (inclined)
Material: Powder coated steel pipe (bronze)

Code: 19940-002-BRZ
Size: L325 x W265 x H197 mm
Weight: 0.96 kg



NEW

T-Collection steel riser bronze vintage (2 tiers)
Material: Powder coated steel pipe (bronze)

Code: 19940-003-BRZ
Size: L355 x W265 x H253 mm
Weight: 1.11 kg



NEW

T-Collection steel riser bronze vintage (3 tiers)
Material: Powder coated steel pipe (bronze)

Code: 19940-004-BRZ
Size: L385 x W265 x H403 mm
Weight: 1.25 kg



NEW

T-Collection steel riser bronze vintage (3 tiers set)
Material: Powder coated steel pipe (bronze)

Code: 19940-005-BRZ
Size: L385 x W265 x H403 mm
Weight: 3.24 kg



NEW

T-Collection wooden cold display (GN 1/2)

Material: Stainless steel 18-10; PMMA (Acrylic); Asy wood; HDPE; Silicone

Code: 18931-002
Size: L325 x W265 x H160 mm
Weight: 4.10 kg



NEW

T-Collection Acrylic Dome Cover (GN 1/2)

Material: Stainless steel 18-10; PMMA (Acrylic)

Code: 19946-002
Size: L302 x W244 x H150 mm
Weight: 1.25 kg

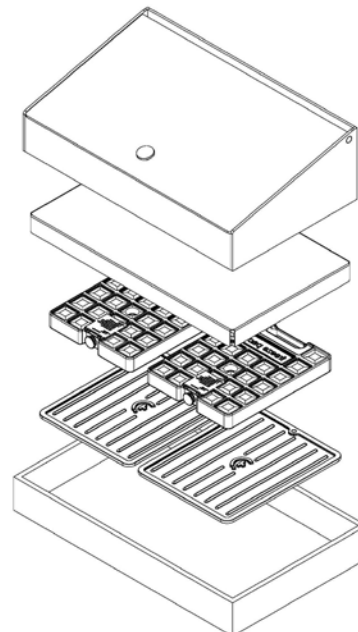



Compatible with G/N size porcelain inserts.



T-Collection steel riser (1 tier)
Material: Powder coated steel pipe (black)
Code: 19938-001
Size: L530 × W325 × H103 mm
Weight: 1.16 kg



T-Collection steel riser (inclined)
Material: Powder coated steel pipe (black)
Code: 19938-002
Size: L530 × W325 × H218 mm
Weight: 1.25 kg

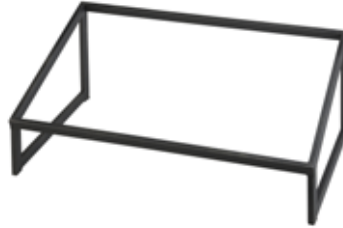

T-Collection steel riser (2 tiers)
Material: Powder coated steel pipe (black)
Code: 19938-003
Size: L560 × W325 × H253 mm
Weight: 1.28 kg

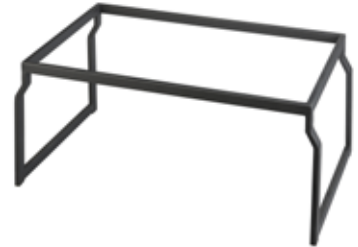

T-Collection steel riser (3 tiers)
Material: Powder coated steel pipe (black)
Code: 19938-004
Size: L590 × W325 × H403 mm
Weight: 1.64 kg



T-Collection steel riser (3 tiers, set)
Material: Powder coated steel pipe (black)
Code: 19938-005
Size: L590 × W325 × H403 mm
Weight: 4.09 kg

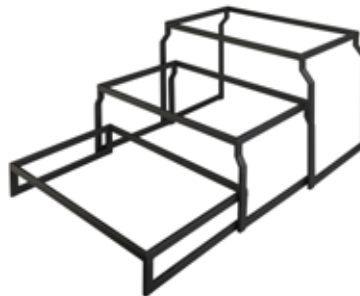

T-Collection ice white Lucite tray
Material: PMMA (Acrylic)
Code: 19118-000
Size: L530 × W325 × H75 mm
Weight: 3.16 kg



T-Collection gray ash wood tray
Material: Ashwood
Code: 19115-400
Size: L530 × W325 × H40 mm
Weight: 1.00 kg



T-Collection gray ash wood tray
Material: Ashwood
Code: 19115-750
Size: L530 × W325 × H75 mm
Weight: 1.32 kg





T-Collection steel riser bronze vintage (1 tier)
Material: Powder coated steel pipe (bronze)

Code: 19938-001-BRZ
Size: L530 x W325 x H103 mm
Weight: 1.16 kg



NEW

T-Collection steel riser bronze vintage (inclined)
Material: Powder coated steel pipe (bronze)

Code: 19938-002-BRZ
Size: L530 x W325 x H218 mm
Weight: 1.25 kg



NEW

T-Collection steel riser bronze vintage (2 tiers)
Material: Powder coated steel pipe (bronze)

Code: 19938-003-BRZ
Size: L560 x W325 x H253 mm
Weight: 1.28 kg



NEW

T-Collection steel riser bronze vintage (3 tiers)
Material: Powder coated steel pipe (bronze)

Code: 19938-004-BRZ
Size: L590 x W325 x H403 mm
Weight: 1.64 kg



NEW

T-Collection steel riser bronze vintage (3tier, set)
Material: Powder coated steel pipe (bronze)

Code: 19938-005-BRZ
Size: L590 x W325 x H403 mm
Weight: 4.09 kg



NEW

T-Collection cold display (GN 1/1)

Material: Stainless steel 18-10; PMMA (Acrylic); Asy wood; HDPE; Silicone

Code: 18931-001
Size: L530 x W325 x H160 mm
Weight: 7.45 kg



NEW

T-Collection Acrylic Dome Cover (GN 1/1)

Material: Stainless steel 18-10; PMMA (Acrylic)

Code: 19946-001
Size: L507 x W304 x H150 mm
Weight: 2.05 kg



NEW

Multi silicone pad

Material: Silicone

Code: 18931-100
Size: L224 x W284 x H6 mm
Weight: 0.27 kg
Package: 2 ea/set



NEW





T-Collection steel riser

Material: Powder coated steel pipe (black)

Code: 19939-001

Size: L530 x W162 x H103 mm

Weight: 0.87 kg



T-Collection steel riser bronze vintage

Material: Powder coated steel pipe (bronze)

Code: 19939-001-BRZ

Size: L530 x W162 x H103 mm

Weight: 0.87 kg



NEW

T-Collection steel riser (inclined)

Material: Powder coated steel pipe (black)

Code: 19939-002

Size: L530 x W162 x H162 mm

Weight: 0.92 kg



T-Collection steel riser bronze vintage (inclined)

Material: Powder coated steel pipe (bronze)

Code: 19939-002-BRZ

Size: L530 x W162 x H162 mm

Weight: 0.92 kg



NEW

T-Collection gray ash wood tray

Material: Asy wood

Code: 19116-400

Size: L530 x W162 x H40 mm

Weight: 0.55 kg



STACKABLE



Wood risers cube

Materiale: Frassino massiccio

CUB010

Dimensioni (LxPxH): 10x10x10 cm

CUB020

Dimensioni (LxPxH): 10x10x20 cm

CUB030

Dimensioni (LxPxH): 10x10x30 cm



Buffet riser set-tiffany

Materiale: Stainless steel 18-10

19934

Confezione: 3 pz/set

Dimensioni (øxH): 300(260)x254 mm
224(205)x205 mm
190(165)x169.5 mm



STACKABLE REVERSIBLE



Cross buffet riser (3 heights)

Materiale: PMMA (Lucite)

19936

Dimensioni (LxPxH): 150x150x180 mm
200x200x240 mm
200x200x300 mm

Peso: 0.55 kg | 0.97 kg | 1.27 kg



STACKABLE REVERSIBLE



Wire buffet riser

Materiale: Stainless steel 18-10

19933

Confezione: 2 pz/set

Dimensioni (LxPxH): 258x172x150 (Ø8.0 mm)
158x103x90.3 (Ø8.0 mm)

Peso: 0.42 kg | 0.25 kg



STACKABLE REVERSIBLE



Risers to go with trays and platters

Materiale: Stainless steel 18-10

Tray not included

INOX563310

Dimensioni (LxPxH): 56x33x10 cm

INOX303310

Dimensioni (LxPxH): 30x33x10 cm



Porcelain Insert Stand

Materiale: Stainless steel 18-10

Porcelain not included

11121

Dimensioni (LxPxH): 577x373x84.4 mm

Peso: 2.3 kg

11122

Dimensioni (LxPxH): 400x374x84.3 mm

Peso: 2 kg



T-Collection buffet stand set

Materiale: Powder coated steel

Code: 19944-000

Package: 3 pcs/set

Size: L190 x W190 x H170 mm

L225 x W225 x H205 mm

L300 x W300 x H225 mm

Weight: 0.55 kg | 0.7 kg | 0.9 kg



STACKABLE REVERSIBLE





Wooden cube, available in 3 sizes. Made of solid ash wood. Elegant and warm as only natural wood can be.







Super mirror trays.
 Made of AISI 304 SS with super-
 mirror finish.
 This range of tray is sleek and
 extremely elegant, can fit in only
 any ambient.

Multi use tray

Materiale: Inox supermirror
 Wooden cube not included

- VAS30X17**
Dimensioni (LxP): 30x17 cm
- VAS35X25**
Dimensioni (LxP): 35x25 cm
- VAS42X18**
Dimensioni (LxP): 42x18 cm
- VAS45X12**
Dimensioni (LxP): 45x12 cm

- VAS49X30**
Dimensioni (LxP): 49x30 cm
- VAS58X16**
Dimensioni (LxP): 58x16 cm
- VAS60X10**
Dimensioni (LxP): 60x10 cm
- VAS60X20**
Dimensioni (LxP): 60x20 cm





VASSOI PASTICCERIA



Vassoi pasticceria bordo 45°

Materiale: Acciaio Inox

PAS 12x58H2

Dimensioni (LxP): 12x58 cm

PAS 20x12H2

Dimensioni (LxP): 20x12 cm

PAS 28x20H2

Dimensioni (LxP): 28x20 cm

PAS 30x20H2

Dimensioni (LxP): 30x20 cm

PAS 30x30H2

Dimensioni (LxP): 30x30 cm

PAS 32x25H2

Dimensioni (LxP): 32x25 cm

PAS 38x20H2

Dimensioni (LxP): 38x20 cm

PAS 49x30H2

Dimensioni (LxP): 49x30 cm

PAS 58x8H2

Dimensioni (LxP): 58x8 cm

PAS 60x10H2

Dimensioni (LxP): 60x10 cm









DISPLAYS



Hi-line cold display

Materiale: Stainless steel 18-10, PC (Polycarbonate) dome cover, HDPE ice pack, Lucite PMMA stand

18911-IWS

Dimensioni (LxPxH): 596x416x285 mm

Peso: 10.10 kg



C2 cold display

Materiale: Stainless steel 18-10, PC (Polycarbonate) dome cover, HDPE ice pack

18919

Dimensioni (LxPxH): 653x390x281 mm

Peso: 10.5 kg



Swatch cold display (metal)

Materiale: Stainless steel 18-10, PC (Polycarbonate) dome cover, HDPE ice pack

18920-MTL

Dimensioni (LxPxH): 608x433x284.4 mm

Peso: 11.9 kg



Bakery showcase 2 levels

Materiale: plastic

Include due vassoi neri: 25,5 x 35,5 cm

SBC1014-2F-06 (Front doors)

Dimensioni (LxPxH): 37 x 37 x 40 mm

SBC1014-2R-06 (Rear door)

Dimensioni (LxPxH): 37 x 37 x 40 mm



Bakery show case 3 levels

Materiale: plastic

Include tre vassoi neri: 35,5 x 45,5 cm

LBC1418-3F-06 (Front doors)

Dimensioni (LxPxH): 47 x 50 x 56 mm

LBC1418-3R-06 (Rear door)

Dimensioni (LxPxH): 47 x 50 x 56 mm



Wooden containers to be combined with impress trays. All compatible sizes available. The inclined version is meant to display more attractively sushi, cold cuts, finger-food..
The beauty of wood, the ability of italian craftsman.



TILTED Wooden containers

Materiale: Walnut

SD60X20IL

Dimensioni (LxPxH): 60x20x10(7) CM



FLAT Wooden containers

Materiale: Walnut

SD40X20

Dimensioni (LxPxH): 40x20x7 CM

SD60X20

Dimensioni (LxPxH): 60x20x7 CM



TRAYS



S.S. G/N tray without handle

Material: Stainless steel 18-10

Code: 18100-000

Package: 3 ea

Size: L526 × W325 × H16 mm

Weight: 2.02 kg



S.S. tray without handle

Material: Stainless steel 18-10

Code: 18101-000

Size: L570 × W425 × H18 mm

Weight: 2.84 kg



S.S. tray without handle

Material: Stainless steel 18-10

Code: 18102-000

Size: L680 × W505 × H18 mm

Weight: 4.02 kg



S.S. tray with handle

Material: Stainless steel 18-10; Solid die casting handle

Code: 18100-HDL

Size: L526 × W325 × H48 mm

Weight: 2.54 kg



STACKABLE



S.S. tray with handle

Material: Stainless steel 18-10; Solid die casting handle

Code: 18101-HDL

Size: L570 × W425 × H48 mm

Weight: 3.9 kg



STACKABLE



S.S. tray with handle

Material: Stainless steel 18-10; Solid die casting handle

Code: 18102-HDL

Size: L680 × W505 × H48 mm

Weight: 4.86 kg



STACKABLE





Multi use tray

Material: Stainless steel 18-10

Code: 19008-100

Size: L499.5 x W304.4 x H26 mm

Weight: 1.95 kg

Code: 19008-200

Multi use tray

Size: L554.5 x W384.4 x H26 mm

Weight: 2.71 kg



Round S.S. Tray

Material: Stainless steel 18-10

Code: 18103-000

Size: D420 mm

Weight: 1.59 kg

Code: 18104-000

Size: D380 mm

Weight: 2.23 kg

Code: 18105-000

Size: D300 mm

Weight: 3.18 kg



NEW







Vassoio color ghisa

Materiale: Stainless steel 18-10

GHI6020

Misura (LxH): 60x20 cm

GHI4020

Misura (LxH): 40x20 cm

GHI3326

Misura (LxH): 33x26 cm



Vassoio color oro

Materiale: Stainless steel 18-10

ORO6020

Misura (LxH): 60x20 cm

ORO4020

Misura (LxH): 40x20 cm

ORO3326

Misura (LxH): 33x26 cm



Vassoio color ruggine

Materiale: Stainless steel 18-10

RUG6020

Misura (LxH): 60x20 cm

RUG4020

Misura (LxH): 40x20 cm

RUG3326

Misura (LxH): 33x26 cm





Vassoio color sabbia

Materiale: Stainless steel 18-10

SAB6020

Misura (LxH): 60x20 cm

SAB4020

Misura (LxH): 40x20 cm

SAB3326

Misura (LxH): 33x26 cm



Tray white transparent

Materiale: methacrylate

METAC325X265

Dimensioni (LxP): 32,5x26,5 cm

METAC530X185

Dimensioni (LxP): 53x18,5 cm

METAC530X325

Dimensioni (LxP): 53x32,5 cm





<p>Glass collection serving dish bicolored Materiale: Glass, White decors 529310 Dimensioni (LxP): 310x310 mm 529210 Dimensioni (LxP): 250x250 mm</p> 	<p>Glass collection border serving dish Materiale: Glass 509120 Dimensioni (LxP): 130x130 mm 509320 Dimensioni (LxP): 170x170 mm 509720 Dimensioni (LxP): 250x250 mm 509920 Dimensioni (LxP): 310x310 mm</p> 	<p>Glass collection square serving dish Materiale: Glass 540870 Dimensioni (LxP): 450x450 mm</p> 
<p>Glass collection rectangular serving dish Materiale: Glass 540270 Dimensioni (LxP): 530x320 mm</p> 	<p>Glass collection small square bowl Materiale: Glass 5011620 Dimensioni (LxP): 100x100 mm</p> 	<p>Glass collection small triangular bowl Materiale: Glass 5011420 Dimensioni (LxP): 100x100x100 mm 5011520 Dimensioni (LxP): 120x120x120 mm</p> 
<p>Glass collection bowl Materiale: Glass 504120 Dimensioni (LxP): 300x300 mm</p> 	<p>Glass collection square salad bowl Materiale: Glass 5543120 Dimensioni (LxP): 130x130 mm 5543220 Dimensioni (LxP): 160x160 mm</p> 	<p>Glass collection square bowl Materiale: Glass 525206 Dimensioni (LxP): 280x280 mm 525204 Dimensioni (LxP): 250x250 mm 525202 Dimensioni (LxP): 200x200 mm 525200 Dimensioni (LxP): 100x100 mm</p> 



Glass collection vassoio a due compart

Materiale: Glass

540027

Dimensioni (LxP): 380x260 mm - h 25 mm



Glass collection gastro tray

Materiale: Glass

540230

Dimensioni (LxP): 530x320 mm

540830

Dimensioni (LxP): 450x450 mm



Glass collection pearl bowl 18

Materiale: Glass









5441330

Dimensioni (Ø): 180 mm

5441330

Dimensioni (Ø): 130 mm



<p>Glass collection rectangular serving dish Zoom Materiale: Glass</p> <p>5452626 Dimensioni (LxP): 400x200 mm</p> <p>5452326 Dimensioni (LxP): 300x150 mm</p> 	<p>Glass collection square serving dish Zoom Materiale: Glass</p> <p>5451526 Dimensioni (LxP): 260x260 mm</p> <p>5451726 Dimensioni (LxP): 320x320 mm</p> 	<p>Glass collection round serving dish Zoom Materiale: Glass</p> <p>5450726 Dimensioni (ø): 360 mm</p> <p>5450526 Dimensioni (ø): 300 mm</p> 
<p>Glass collection square serving dish Canapè Materiale: Glass</p> <p>5011120 Dimensioni (LxP): 120x120 mm</p> 	<p>Glass collection wavy serving dish Canapè Materiale: Glass</p> <p>5010320 Dimensioni (LxP): 100x100 mm</p> 	<p>Glass collection serving dish Quadro Materiale: Glass</p> <p>5010120 Dimensioni (LxP): 80x60 mm</p> 
<p>Glass collection square tray Bridge Materiale: Glass</p> <p>5411320 Dimensioni (LxP): 280x280 mm</p> 	<p>Glass collection rectangular tray Bridge Materiale: Glass</p> <p>5411120 Dimensioni (LxP): 240x120 mm</p> <p>5411220 Dimensioni (LxP): 450x150 mm</p> 	

BOWLS



Cloud buffet trays

Material: Stainless steel 18-10

Code: 40015-100

Size: D330 × H80 mm (1.2 T)

Weight: 0.4 kg

Code: 40015-200

Size: D580 × H80 mm (1.2 T)

Weight: 0.64 kg

Code: 40015-100-RGD (rose gold) ON REQUEST

Size: D580 × H80 mm (1.2 T)

Weight: 0.64 kg



Square buffet bowl

Material: Stainless steel 18-10

Code: 19002-100

Size: D340 × H64 mm

Weight: 0.70 kg

Code: 19002-200

Size: D405 × H98 mm

Weight: 0.85 kg



Crescent bowl

Material: Stainless steel 18-10; Solid die casting

Code: 40019-100

Size: L220 × W105 × H77 mm

Weight: 0.18 kg

Code: 40019-200

Size: L420 × W220 × H150 mm

Weight: 0.73 kg



Crescent bowl with handle

Material: Stainless steel 18-10; Aluminum alloys (chrome plated); Solid die casting

Code: 40019-300

Size: L220 × W105 × H131 mm

Weight: 0.28 kg

Code: 40019-400

Size: L420 × W220 × H287.5 mm

Weight: 0.96 kg



Moon fruit tray

Material: Stainless steel 18-10

Code: 19001-000

Size: D389 × H296.8 mm

Weight: 1.7 kg



Relish dish-3 compartment

Material: Stainless steel 18-10; Aluminum alloys (chrome plated)

Code: 40023-000

Size: L178 × W166 × H132.6 mm

Weight: 0.45 kg

Capacity: 0.2 Ltr (1 compartment)



Odin swivel fruit dispenser

Material: Stainless steel 18-10; Aluminum alloys (chrome plated)

Code: 18510-000

Size: D328 × H565 mm

Weight: 4.5 kg







STANDS



Pastry stand (1 tier)

Material: Stainless steel 18-10; Solid die casting

Code: 18928-000

Size: D388 x H172 mm
Weight: 1.14 kg



Pastry stand cover

Material: PMMA(Acrylic)

Code: 18929-000

Size: D298 x H171.5 mm
Weight: 0.58 kg



Tray white transparent

Materiale: Methacrylate trays dual color

METAC340

Dimensioni (ø): 34 cm



Fruit stand (1 tier)

Material: Stainless steel 18-10; Alluminium alloys (chrome plated)

Code: 18926-000

Size: D325 x H200 mm
Weight: 1.13 kg



Fruit stand (3 tiers)

Material: Stainless steel 18-10; Solid die casting

Code: 18925-000

Size: D375 x H530 mm
Weight: 3.10 kg



Pastry stand (3 tiers)

Material: Stainless steel 18-10; Solid die casting

Code: 18927-000

Size: D438 x H495 mm
Weight: 3.56 kg



Round tea stand

Material: Stainless steel 18-10; Aluminum alloy (Chrome plated)

Code: 40017-100

Size: D210 x H227.7 mm
Weight: 0.55 kg

Code: 40017-100-RGD (rose gold) ON REQUEST

Size: D210 x H227.7 mm
Weight: 0.55 kg



Square tea stand

Material: Stainless steel 18-10; Aluminum alloy (Chrome plated)

Code: 40017-200

Size: L210 x W210 x H227.2 mm
Weight: 0.62 kg

Code: 40017-200-RGD (rose gold) ON REQUEST

Size: L210 x W210 x H227.2 mm
Weight: 0.62 kg





Buffet&cake stand

Material: Stainless steel 18-10; Solid die casting

Code: 19006-100

Size: D160 × H117.3 mm

Weight: 0.7 kg

Code: 19006-200

Size: D210 × H153.4 mm

Weight: 0.96 kg

Code: 19006-300

Size: D300 × H157.8 mm

Weight: 1.52 kg



Tea stand

Material: Stainless steel 18-10

Dish not included

Code: 18917-000

Size: L256 × W256 × H421 mm

Weight: 0.68 kg

Code: 18918-000

Size: L196 × W196 × H255.5 mm

Weight: 0.42 kg



Swivel high tea stand

Material: Stainless steel 18-10

Code: 19010-000

Size: L368 × W202.5 × H428 mm

Weight: 2.17 kg



SWIVEL





4 Crocks system stand

Materiale: Melamine
Crocks not included

P22158

Dimensioni (LxPxH): 190x525x325 mm
Compatibile con: 1l crock P22160



1l crock

Materiale: Melamine

P22160

Confezione: 6 pz
Dimensioni (øxH): 130x105 mm
Compatibile con: 4 Crocks system stand P22158





Pastry rotary stand

Material: Stainless steel 18-10; Solid die casting; PC

Code: 19003-100

Size: D314 × H526 mm

Weight: 2.66 kg
(polycarbonate)



High pastry rotary stand

Material: Stainless steel 18-10; Solid die casting; PC

Code: 19003-200

Size: D314 × H680 mm

Weight: 3.1 kg
(polycarbonate)



Muffin and more stand

Material: Stainless steel 18-10

Code: 19004-000

Size: L411.5 × W412.5 × H446.5 mm

Weight: 3.1 kg

Related accessories 19005 and 40014-000

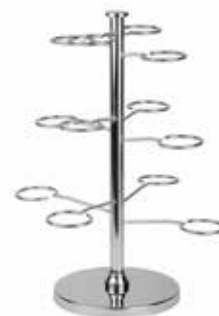







Round coaster

Material: Stainless steel 18-10

Code: 40014-000

Size: D117 x 1T

Weight: 0.07 kg

Code: 40014-000-RGD (rose gold) ON REQUEST

Size: D117 x 1T

Weight: 0.07 kg



Display cup

Material: Glass

Code: 19005-000

Size: D65.8 x H56.6 mm

Weight: 0.05 kg

Compatible with: 19004









Square crystal block

Material: Crystal

Code: 19908-000

Size: L122 × W122 × H78 mm
Weight: 1.08 kg

Code: 19909-000

Size: L122 × W122 × H120 mm
Weight: 1.4 kg

Code: 19910-000

Size: L122 × W122 × H183 mm
Weight: 1.9 kg



Oblong platform

Material: PMMA(Acrylic)

Code: 19913-000

Size: L420 × W200 × H59 mm
Weight: 1.02 kg

Code: 19914-000

Size: L320 × W201 × H59 mm
Weight: 0.73 kg



Square platform

Material: PMMA(Acrylic)

Code: 19915-000

Size: L201 × W201 × H69 mm
Weight: 0.48 kg



Round platform

Material: PMMA(Acrylic)

Code: 19916-000

Size: D200 × H59 mm
Weight: 0.38 kg



Led battery operated light

Material: PMMA(Acrylic)

Code: 19917-000

Size: D51 × H39 mm
Weight: 0.04 kg



Made of solid ash wood.
With water painting finish.
Enhance your presentation with a
natural touch!



Wood risers

Materiale: Frassino massiccio

SCALA76

Dimensioni totali: 76x46 cm H.22

Ripiani da 11 cm

Ripiano alto da 13 cm con fori per stick.



Bread box

Con due divisori removibili e supporti per esposizione
inclinata su due lati.

Materiale: Frassino massiccio

B52X28

Dimensioni totali: 52x28 cm H 6



Porta marmellata reversibile

4 fori per contenitori da un lato, 10 fori per spiedini
sull'altro.

Materiale: Frassino massiccio

REVERS46X13

Dimensioni totali: 46x13 H 2





Wood risers

BLOCK13

Dimensioni totali: 30x30x13 cm

BLOCK17

Dimensioni totali: 30x30x17 cm

BLOCK21

Dimensioni totali: 30x30x21 cm



Wood risers

Materiale: Frassino massiccio

RISER12

Dimensioni totali: 40x12 cm H 6

RISER10

Dimensioni totali: 33x10 cm H 4

RISER8

Dimensioni totali: 25x8 cm H 2.5



Bamboo displayer with 3 bowls

Crocks not included
Materiale: Melamine

P22220

Confezione: 6 pz

Dimensioni (LxPxH): 290x110x35 mm

P22220

Confezione: 6 pz

Dimensioni (LxPxH): 400x130x60 mm

P22220

Dimensioni (LxPxH): 495x160x85 mm

Confezione: 6 pz



Treasure stand with acacia wood

Materiale: Wood, Plexiglass

TREASURY-PLEXY

Dimensioni (LxPxH): 400x400x55 mm

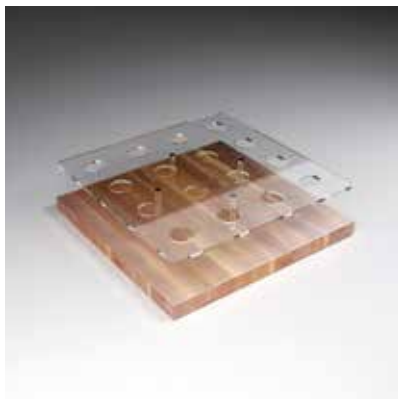

Coni in bamboo 100 pcs

Materiale: Bamboo

CONO185

Confezione: 100 pcs/set

Dimensioni (H): 185 mm

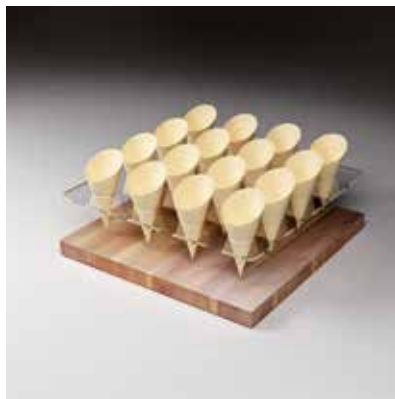

Piattini in ceramica fusion square

Materiale: New Bone China

HW3000311

Dimensioni (LxPxH): 110x110x40 mm



Treasure stand set with acacia wood

Materiale: Stainless steel 18-10 18/10, Mdf, Glass

TREASURY36

Dimensioni (LxPxH): 400x400x350 mm

Include: 19925-185, 19925-245, 19925-305



Treasure stand set with acacia wood

Materiale: Stainless steel 18-10 18/10, Mdf, Glass

TREASURY18

Dimensioni (LxPxH): 400x200x350 mm

Include: 19925-185, 19925-245, 19925-305



Shooter glass

Materiale: Glass

19926-100

Confezione: 36 pcs/set

Dimensioni (øxH): 37x77 mm

Capacità: 0.03 L



Spiral stand

Materiale: Stainless steel 18-10 18/10

19925-185 - Confezione: 12 pz (36 pcs/set)

Dimensioni (LxPxH): 40x185 mm

19925-245 - Confezione: 12 pz (36 pcs/set)

Dimensioni (LxPxH): 40x245 mm

19925-305 - Confezione: 12 pz (36 pcs/set)

Dimensioni (øxH): 40x305 mm

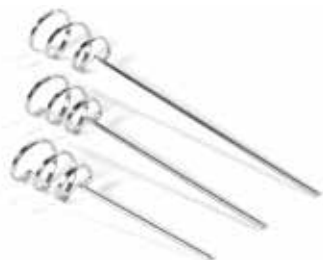

Solid wood base

19924

Dimensioni (LxPxH): 400x400x55 mm

Peso: 6.44 kg



Solid marble base

19932

Dimensioni (LxPxH): 400x400x55 mm

Peso: 6.44 kg





Glass collection supporto

Materiale: Glass

56000621

Dimensioni (H): 120 mm
Compatibile con: 540022

56000631

Dimensioni (H): 100 mm
Compatibile con: 540021



Glass collection espositore buffet

Materiale: Glass

540022

Dimensioni: 600x120 mm
Compatibile con: 5600063



Glass collection espositore steps

Materiale: Glass

540019

Dimensioni: 600x400 mm - h 200 mm

540018

Dimensioni: 600x400 mm - h 120 mm



Glass collection supporto

Materiale: Glass

5600062

Dimensioni (H): 200 mm

5600063

Dimensioni (H): 120 mm



Glass collection espositore buffet ondulato

Materiale: Glass

540021

Dimensioni: 880x480 mm

Compatibile con: 56000631



Glass collection espositore buffet ondulato

Materiale: Glass

540023

Dimensioni: 650x480 mm







VASSOIO ARTIGIANALE





Hand made in Italy.
Realizzato artigianalmente con doghe di botte.
Ogni pezzo è unico.

Vassoio artigianale
Materiale: Doghe di botte
BARRELTRAYWIDE
Dimensioni indicative: 700L x 350P mm





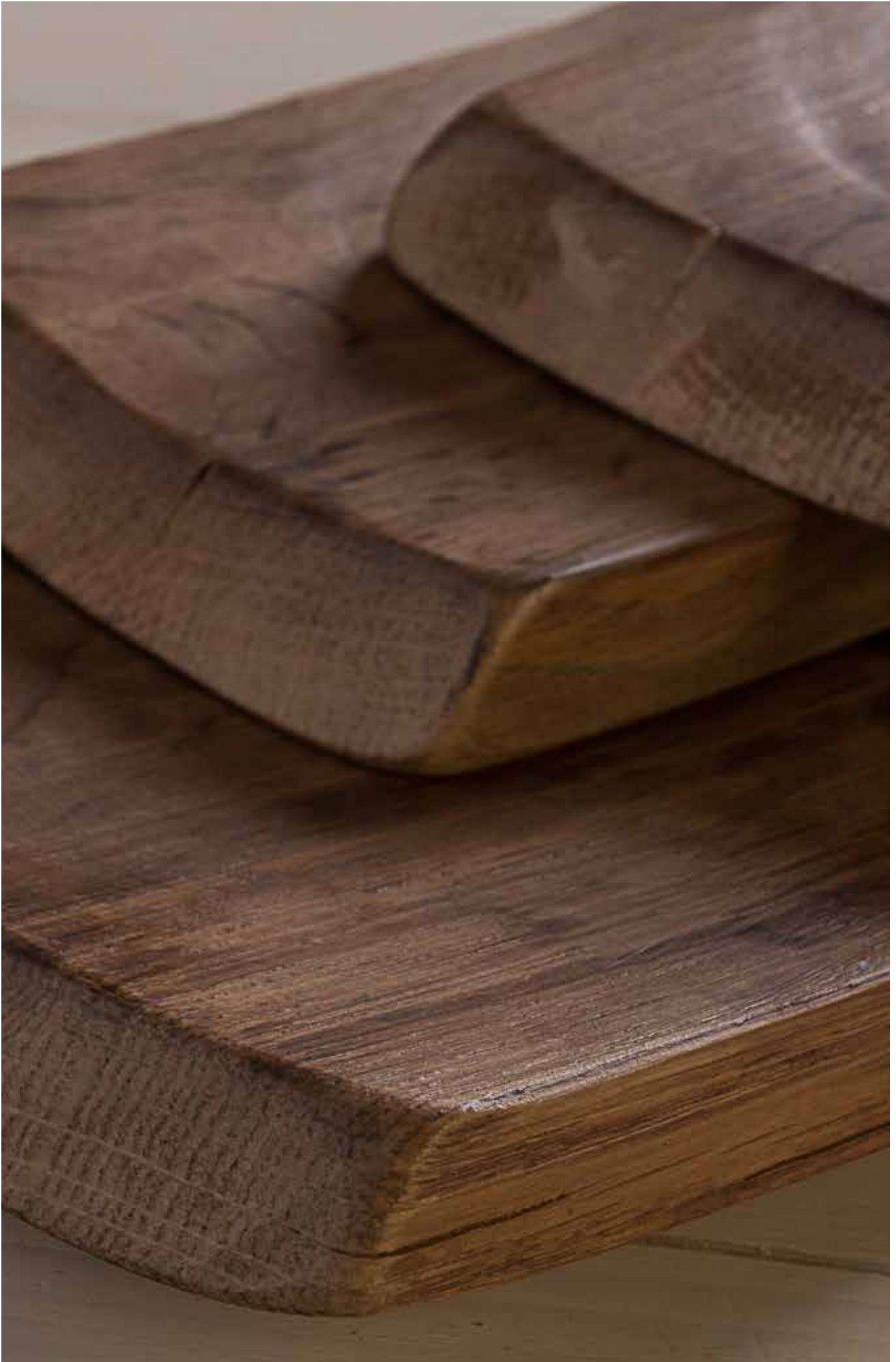

WOODEN BOXES

The cas collection of wooden boxes is designed to offer your guest "a fresh market feeling". All boxes are made of natural wood with different external finish. Cotton liner available for all sizes. Light, resistant and stackable!



High wooden box natural

Materiale: durmast wood

CAS304015

Dimensioni (LxPxH): 30x40x15 CM



High wooden box black

Materiale: durmast wood

CAS304015NER

Dimensioni (LxPxH): 30x40x15 CM



Wooden riser natural

Materiale: durmast wood

CAS304030SF

Dimensioni (LxPxH): 30x40x30 CM





Tilted wooden box inclined natural

Materiale: durmast wood

CAS3040INC

Dimensioni (LxPxH): 30x40x15 CM

Tilted wooden box inclined black

Materiale: durmast wood

CAS3040INCNER

Dimensioni (LxPxH): 30x40x15 CM



Low wooden box natural

Materiale: durmast wood

CAS304075

Dimensioni (LxPxH): 30x40x7,5 CM



Low wooden box black

Materiale: durmast wood

CAS304075NER

Dimensioni (LxPxH): 30x40x7,5 CM



CASSETTINE COLAZIONE



Tribune Buffet

Materiale: Legno rovere

TRIBUNE BUFFET

Dimensioni (LxPxH1xH2): 285x238x18x7 CM



Usò reversibile, ideale per esposizione vasetti confettura da 28 gr.



Cassettine colazione

Materiale: Legno rovere

CAS GN1/4

Dimensioni (LxPxH): 28x16x7,5 CM



Cassettine colazione

Materiale: Legno rovere

CAS GN1/2

Dimensioni (LxPxH): 32x26x7,5 CM







The cylinder risers collection will enhance the look of your buffet, giving a warm and modern touch. All risers can be used as containers. Cotton liners available for all sizes.





Natural wood risers cylindrical

Materiale: wood

CIL223X120NAT

Dimensioni (øxH): 223x120 mm

CIL223X180NAT

Dimensioni (øxH): 223x180 mm

CIL223X240NAT

Dimensioni (øxH): 223x240 mm

CIL300X120NAT

Dimensioni (øxH): 300x120 mm

CIL300X180NAT

Dimensioni (øxH): 300x180 mm

CIL300X240NAT

Dimensioni (øxH): 300x240 mm



Walnut wood risers cylindrical

Materiale: wood

CIL223X120NOC

Dimensioni (øxH): 223x120 mm

CIL223X180NOC

Dimensioni (øxH): 223x180 mm

CIL223X240NOC

Dimensioni (øxH): 223x240 mm

CIL300X120NOC

Dimensioni (øxH): 300x120 mm

CIL300X180NOC

Dimensioni (øxH): 300x180 mm

CIL300X240NOC

Dimensioni (øxH): 300x240 mm



Black wood risers cylindrical

Materiale: wood

CIL223X120NER

Dimensioni (øxH): 223x120 mm

CIL223X180NER

Dimensioni (øxH): 223x180 mm

CIL223X240NER

Dimensioni (øxH): 223x240 mm

CIL300X120NER

Dimensioni (øxH): 300x120 mm

CIL300X180NER

Dimensioni (øxH): 300x180 mm

CIL300X240NER

Dimensioni (øxH): 300x240 mm



PRESENTATION SETS



Twin arm food tag

Material: Stainless steel 18-10

Code: 19921 (157 mm)

Package: 10 ea

Size: L73 x W73 x H157 mm

Weight: 0.16 kg

Code: 19922 (255 mm)

Package: 10 ea

Size: L73 x W87 x H255 mm

Weight: 0.22 kg



Rolly polly food tag

Material: Solid die casting; Chrome plated; ABS w/pearl color with glitter; Stainless steel wire

Code: 19937-000

Package: 1 ea

Size: L55 x W90 x H230 mm

Weight: 0.35 kg



Mr. Tag

Material: Stainless steel 18-10

Code: 19928 (120 mm)

Package: 10 ea

Size: L35 x W48 x H120 mm

Weight: 0.04 kg

Code: 19929 (180 mm)

Package: 10 ea

Size: L54 x W63 x H180 mm

Weight: 0.10 kg



Condiment set

Material: PMMA (Acrylic); Stainless steel 18-10; Borosilicate glass; Silicone

Code: 19904-084

Size: L360 x W110 x H114 mm

Weight: 1.8 kg

Capacity: 0.17 Ltr



Condiment set ash wood stand

Material: Stainless steel 18-10; Borosilicate glass; Asy wood

Code: 19904-000-ASH

Package: 4 jars + 4 spoons + tray

Size: L400 x W120 x H97.5 mm

Weight: 1.59 kg

Items: 19905; 19906; 19907



Condiment set ash wood stand

Material: Stainless steel 18-10; Borosilicate glass; Asy wood

Code: 19904-160-ASH

Size: L400 x W120 x H173.5 mm

Weight: 2.08 kg

Capacity: 0.37 Ltr



NEW

NEW

Condiment set S.S. 18-10 (high)

Material: Stainless steel 18-10; Borosilicate glass; Silicone

Code: 19904-160

Size: L360 x W110 x H183 mm

Weight: 1.9 kg

Capacity: 0.37 Ltr



Condiment set S.S. 18-10

Material: Stainless steel 18-10; Borosilicate glass; Silicone

Code: 19904-000

Package: 4 jars + 4 spoons + tray

Size: L360 x W110 x H107 mm

Weight: 1.47 kg

Items: 19905; 19906; 19907



Condiment set items:

Jam&jelly jar server (1 ea)

Material: Stainless steel 18-10; Borosilicate glass

Code: 19905-100

Size: D80.5 x W85.5 mm

Weight: 0.18 kg

Condiment spoon (1 ea)

Material: Stainless steel 18-10

Code: 19906-000

Size: H140 mm

Weight: 0.0125 kg

Tray

Material: Stainless steel 18-10; Silicone

Code: 19907-000

Size: L360 x W110 x H67 mm

Weight: 0.72 kg

Dressing set

4 pcs of porcelain included

Material: Stainless steel 18-10; PMMA (Acrylic); Porcelain, Silicone

Code: 19935-000

Size: L755 x W150 x H79 mm

Weight: 3.5 kg



ROOM SERVICE TROLLEYS & HOT FOOD WARMERS



Royal room service trolley
 Material: Stainless steel 18-10; Melamine coated plywood;
 Powder coated steel
Code: 20783-RVS
 Size: L106.7 x W91.5 x H75.5 cm
 Weight: 28.8 kg

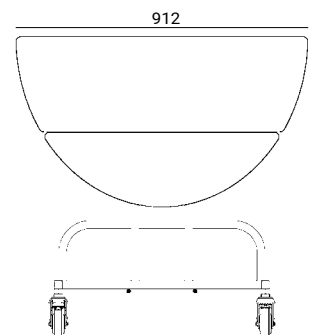
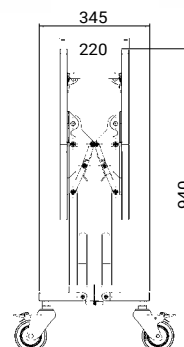
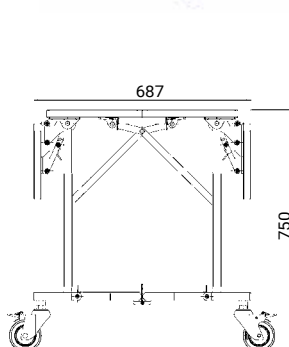



Palace room service trolley

Material: Melamine coated plywood; Powder coated steel

Code: 20782

Size: D102 × H75 cm

Weight: 26.7 kg

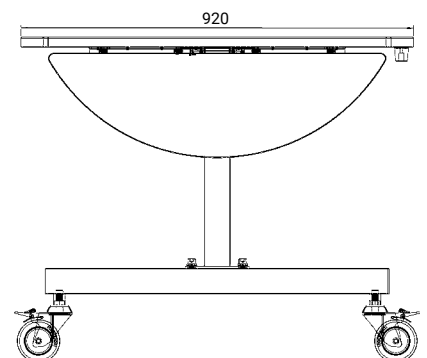
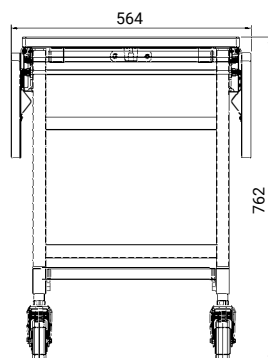

FEATURES:

1. Convenient temperature display window
2. Improved on the heat retention (keep the temp. up to 40°)
3. Convenient AC socket position on a side of warmer for easy management the power cord
4. Modern and elegantly rounded design with black PVD coated stainless steel
5. Anti-scratch door latch
6. Ergonomic built-in side handles
7. Accurate temperature control thanks to PCB



New generation hot food warmer (230 V)

Material: Stainless steel 18-10 (PVD coated); Aluminium

Code: 11812-230

Rating: 230V, 365W

Size: L388 × W393 × H487.5

Weight: 10.4 kg



Hot food warmer

Material: Stainless steel 18-10

Code: 11811-304-230V, 11811-304-110V

Rating: 230V, 365W

Size: L390 × W370 × H495 mm



Hot food warmer caddy

Material: Stainless steel 18-10; Powder coated steel pipe (black)

Code: 11811-CAD

Size: L167.5 × W52.8 × H186.2 cm



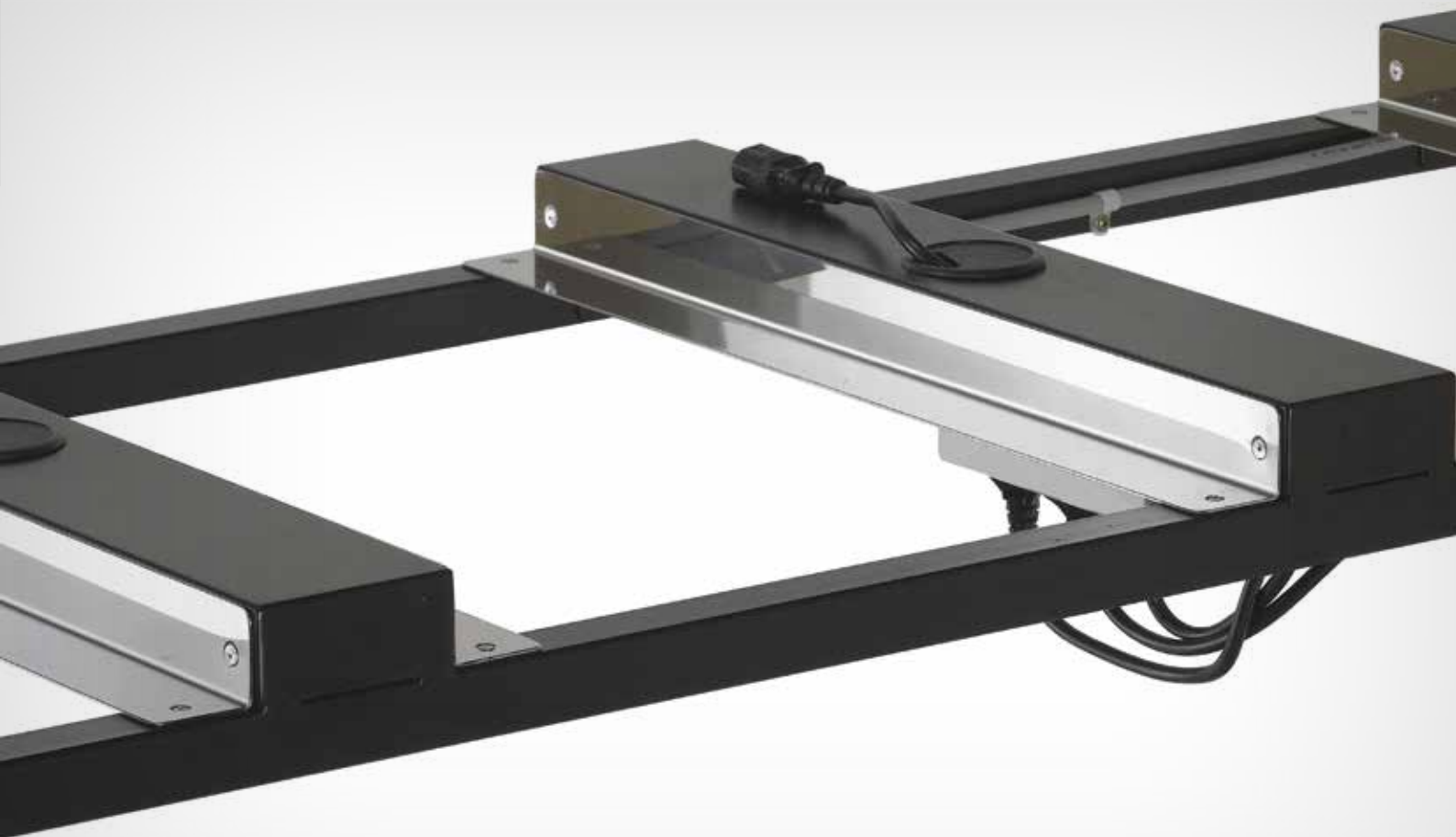

table top





















New bone china Luzerne



TIN TIN COLLECTION



<p>Bowl Zuppa - BLU Materiale: New Bone China TT2420019BL Dimensioni (ø): 190 mm</p> 	<p>Bowl Zuppa - GIALLO Materiale: New Bone China TT2420019YE Dimensioni (ø): 190 mm</p> 	<p>Bowl Zuppa - GREEN Materiale: New Bone China TT2420019GR Dimensioni (ø): 190 mm</p> 
<p>Bowl Zuppa - ROYAL BLU Materiale: New Bone China TT2420019RB Dimensioni (ø): 190 mm</p> 	<p>Cilindro - BLU Materiale: New Bone China TT2130145BL Capacità: 45 cl</p> 	<p>Cilindro - GIALLO Materiale: New Bone China TT2130145YE Capacità: 45 cl</p> 
<p>Cilindro - GREEN Materiale: New Bone China TT2130145GR Capacità: 45 cl</p> 	<p>Cilindro - ROYAL BLU Materiale: New Bone China TT2130145RB Capacità: 45 cl</p> 	<p>Piatto piano - BLU Materiale: New Bone China TT2101021BL Dimensioni (ø): 210 mm TT2101027BL Dimensioni (ø): 270 mm</p> 

<p>Piatto piano - GIALLO Materiale: New Bone China TT2101021YE Dimensioni (ø): 210 mm TT2101027YE Dimensioni (ø): 270 mm</p> 	<p>Piatto piano cm 21 - GREEN Materiale: New Bone China TT2101021GR Dimensioni (ø): 210 mm TT2101027GR Dimensioni (ø): 270 mm</p> 	<p>Piatto piano cm 21 - ROYAL BLU Materiale: New Bone China TT2101021RB Dimensioni (ø): 210 mm TT2101027RB Dimensioni (ø): 270 mm</p> 
<p>Piatto fondo - BLU Materiale: New Bone China TT2120024BL Dimensioni (ø): 240 mm</p> 	<p>Piatto fondo - GIALLO Materiale: New Bone China TT2120024YE Dimensioni (ø): 240 mm</p> 	<p>Piatto fondo - GREEN Materiale: New Bone China TT2120024GR Dimensioni (ø): 240 mm</p> 
<p>Piatto fondo - ROYAL BLU Materiale: New Bone China TT2120024RB Dimensioni (ø): 240 mm</p> 	<p>Piatto rettangolare cm 27 - BLU Materiale: New Bone China TT2103027BL Dimensioni (LxPxH): 265x172x31 mm</p> 	<p>Piatto rettangolare cm 27 - GIALLO Materiale: New Bone China TT2103027YE Dimensioni (LxPxH): 265x172x31 mm</p> 

Piatto rettangolare - GREEN

Materiale: New Bone China

TT2103027GR

Dimensioni (LxPxH): 265x172x31 mm



Piatto rettangolare - ROYAL BLU

Materiale: New Bone China

TT2103027RB

Dimensioni (LxPxH): 265x172x31 mm











MARBLE COLLECTION





Marble round coupe plate

Materiale: New Bone China

MB1401016

Confezione: 48 pcs

Dimensioni (øxH): 158x17.5 mm

MB1401023

Confezione: 24 pcs

Dimensioni (øxH): 226x22 mm

MB1401028

Confezione: 12 pz

Dimensioni (øxH): 278x23 mm



Marble bowl

Materiale: New Bone China

MB6303014

Confezione: 36 pcs

Dimensioni (øxH): 139x68 mm

Capacità: 139 ml



Marble round deep coupe plate

Materiale: New Bone China

MB6102023

Confezione: 12 pz

Dimensioni (øxH): ø230x51 mm

Capacità: 882 ml

MB6102026

Confezione: 12 pz

Dimensioni (øxH): ø258x59 mm

Capacità: 1417 ml



LEATHER COLLECTION



Leather round coupe plate

Materiale: New Bone China

LT6110021

Confezione: 24 pz

Dimensioni (øxH): 205x28 mm

LT6110027

Confezione: 12 pz

Dimensioni (øxH): 275x30 mm

LT6110031

Confezione: 12 pz

Dimensioni (øxH): 310x35 mm



Leather bowl

Materiale: New Bone China

LT6120014

Confezione: 48 pz

Dimensioni (øxH): 145x41 mm

Capacità: 238 ml

LT6120029

Confezione: 6 pz

Dimensioni (øxH): 290x80 mm

Capacità: 2220 ml



Leather bowl

Materiale: New Bone China

LT6122023

Confezione: 12 pz

Dimensioni (øxH): 228x102 mm

Capacità: 1674 ml



KNIT COLLECTION



Knit deep round plate

Materiale: New Bone China
Confezione: 12 pz

KT1202123NB (navy blue) ●
Dimensioni (øxH): 230x51 mm
Capacità: 706 ml

KT1202123MW (white) ○
Dimensioni (øxH): 230x51 mm
Capacità: 706 ml



Knit round plate

Materiale: New Bone China
Confezione: 12 pz

KT1201018NB (navy blue) ●
Dimensioni (øxH): 180x30 mm

KT1201018MW (white) ○
Dimensioni (øxH): 180x30 mm

KT1201026MW (white) ○
Dimensioni (øxH): 260x30 mm

KT1202128NB (navy blue) ●
Dimensioni (øxH): 285x30 mm

KT1202128MW (white) ○
Dimensioni (øxH): 285x30 mm



Knit Rectangular plate

Materiale: New Bone China
Confezione: 48 pz

KT1203018NB (navy blue) ●
Dimensioni (øxH): 174x21 mm

KT1203018MW (white) ○
Dimensioni (øxH): 174x21 mm



LAVA COLLECTION





Lava plate

Materiale: New Bone China

LV1401021

Confezione: 24 pcs

Dimensioni (øxH): 204x8.5 mm

LV1401028

Confezione: 12 pz

Dimensioni (øxH): 283x22.5 mm



Lava deep round plate

Materiale: New Bone China

LV6102023

Confezione: 12 pz

Dimensioni (øxH): 230x51 mm

Capacità: 882 ml

LV6102026

Confezione: 12 pz









Dimensioni (øxH): 258x59 mm

Capacità: 1417 ml











RUSTIC GREY COLLECTION



<p>Rustic grey round coupe plate Materiale: New Bone China</p> <p>RU1201017CH Dimensioni (øxH): 165x22 mm</p> <p>RU1201022CH Dimensioni (øxH): 215x28 mm</p> <p>RU1201027CH Dimensioni (øxH): 265x30 mm</p> <p>RU1201031CH Dimensioni (øxH): 310x35 mm</p> 	<p>Rustic grey oval coupe plate Materiale: New Bone China</p> <p>RU3401019CH Dimensioni (LxPxH): 185x155x30 mm</p> <p>RU3401022CH Dimensioni (LxPxH): 225x185x31 mm</p> <p>RU3401029CH Dimensioni (LxPxH): 290x245x47 mm</p> 	<p>Rustic grey insalatiera Materiale: New Bone China</p> <p>RU3403016CH Dimensioni (LxPxH): 155x145x69 mm Capacità: 408 ml</p> <p>RU3403019CH Dimensioni (LxPxH): 190x170x84 mm Capacità: 716 ml</p> 
<p>Rustic grey coppetta Materiale: New Bone China</p> <p>RU3403011CH Dimensioni (LxPxH): 115x105x61 mm Capacità: 230 ml</p> 	<p>Rustic grey tapered square dish Materiale: New Bone China</p> <p>RU6071007CH Dimensioni (LxPxH): 70x70x36 mm Capacità: 50 ml</p> 	<p>Rustic grey pickle dish Materiale: New Bone China</p> <p>RU6076007CH Dimensioni (LxPxH): 80x65x60 mm Capacità: 47 ml</p> 
<p>Rustic grey mini tegame Materiale: New Bone China</p> <p>RU2601210CH Dimensioni (LxPxH): 95x70x36 mm Capacità: 85 ml</p> 	<p>Rustic grey cup Materiale: New Bone China</p> <p>RU1407111CH Dimensioni (LxPxH): 90x70x49 mm Capacità: 86 ml</p> <p>RU1415412CH (Coupe Saucer) Dimensioni (øxH): 180x19 mm</p> <p>RU1407124CH Dimensioni (LxPxH): 115x90x61 mm Capacità: 185 ml</p> <p>RU1415416CH (Coupe Saucer) Dimensioni (øxH): 150x25 mm</p> 	







RUSTIC SABBIA COLLECTION



<p>Rustic sabbia round coupe plate Materiale: New Bone China</p> <p>RU1201017SA Dimensioni (øxH): 165x22 mm</p> <p>RU1201022SA Dimensioni (øxH): 215x28 mm</p> <p>RU1201027SA Dimensioni (øxH): 265x30 mm</p> <p>RU1201031SA Dimensioni (øxH): 310x35 mm</p> 	<p>Rustic sabbia oval coupe plate Materiale: New Bone China</p> <p>RU3401019SA Dimensioni (LxPxH): 185x155x30 mm</p> <p>RU3401022SA Dimensioni (LxPxH): 225x185x31 mm</p> <p>RU3401029SA Dimensioni (LxPxH): 290x245x47 mm</p> 	<p>Rustic sabbia insalatiera Materiale: New Bone China</p> <p>RU3403016SA Dimensioni (LxPxH): 155x145x69 mm Capacità: 408 ml</p> <p>RU3403019SA Dimensioni (LxPxH): 190x170x84 mm Capacità: 716 ml</p> 
<p>Rustic sabbia coppetta Materiale: New Bone China</p> <p>RU3403011SA Dimensioni (LxPxH): 115x105x61 mm Capacità: 230 ml</p> 	<p>Rustic sabbia tapered square dish Materiale: New Bone China</p> <p>RU6071007SA Dimensioni (LxPxH): 70x70x36 mm Capacità: 50 ml</p> 	<p>Rustic sabbia pickle dish Materiale: New Bone China</p> <p>RU6076007SA Dimensioni (LxPxH): 80x65x60 mm Capacità: 47 ml</p> 
<p>Rustic sabbia mini tegame Materiale: New Bone China</p> <p>RU2601210SA Dimensioni (LxPxH): 95x70x36 mm Capacità: 85 ml</p> 	<p>Rustic sabbia cup Materiale: New Bone China</p> <p>RU1407111SA Dimensioni (LxPxH): 90x70x49 mm Capacità: 86 ml</p> <p>RU1415412SA (Coupe Saucer) Dimensioni (øxH): 180x19 mm</p> <p>RU1407124SA Dimensioni (LxPxH): 115x90x61 mm Capacità: 185 ml</p> <p>RU1415416SA (Coupe Saucer) Dimensioni (øxH): 150x25 mm</p> 	

RUSTIC TERRAROSSA COLLECTION



<p>Rustic terrarossa round coupe plate Materiale: New Bone China</p> <p>RU1201017CR Dimensioni (øxH): 165x22 mm</p> <p>RU1201022CR Dimensioni (øxH): 215x28 mm</p> <p>RU1201027CR Dimensioni (øxH): 265x30 mm</p> <p>RU1201031CR Dimensioni (øxH): 310x35 mm</p> 	<p>Rustic terrarossa oval coupe plate Materiale: New Bone China</p> <p>RU3401019CR Dimensioni (LxPxH): 185x155x30 mm</p> <p>RU3401022CR Dimensioni (LxPxH): 225x185x31 mm</p> <p>RU3401029CR Dimensioni (LxPxH): 290x245x47 mm</p> 	<p>Rustic terrarossa insalatiera Materiale: New Bone China</p> <p>RU3403016CR Dimensioni (LxPxH): 155x145x69 mm Capacità: 408 ml</p> <p>RU3403019CR Dimensioni (LxPxH): 190x170x84 mm Capacità: 716 ml</p> 
<p>Rustic terrarossa coppetta Materiale: New Bone China</p> <p>RU3403011CR Dimensioni (LxPxH): 115x105x61 mm Capacità: 230 ml</p> 	<p>Rustic terrarossa tapered square dish Materiale: New Bone China</p> <p>RU6071007CR Dimensioni (LxPxH): 70x70x36 mm Capacità: 50 ml</p> 	<p>Rustic terrarossa pickle dish Materiale: New Bone China</p> <p>RU6076007CR Dimensioni (LxPxH): 80x65x60 mm Capacità: 47 ml</p> 
<p>Rustic terrarossa mini tegame Materiale: New Bone China</p> <p>RU2601210CR Dimensioni (LxPxH): 95x70x36 mm Capacità: 85 ml</p> 		

ECO COLLECTION



Round deep coupe plate

Materiale: New Bone China

IF610201

Dimensioni (øxH): 210x45 mm
Capacità: 705 ml

IF610203

Dimensioni (øxH): 230x51 mm
Capacità: 882 ml

IF610206

Dimensioni (øxH): 258x59 mm
Capacità: 1.417 l

IF610208

Dimensioni (øxH): 278x62 mm
Capacità: 1.805 l



Bowl

Materiale: New Bone China

FM1120015

Dimensioni (øxH): 152x55 mm
Capacità: 557 ml

FM1120019

Dimensioni (øxH): 190x71 mm
Capacità: 1201 ml



Eco coil plate

Materiale: New Bone China

FM1101021

Dimensioni (øxH): 212x22 mm

FM1101027

Dimensioni (øxH): 270x24 mm











CHINA WHITE COLLECTION



<p>China white round rim plate Materiale: New Bone China</p> <p>CW1101021 Dimensioni (øxH): 210x20 mm</p> <p>CW1101025 Dimensioni (øxH): 250x24 mm</p> <p>CW1101027 Dimensioni (øxH): 270x25 mm</p> <p>CW1101030 Dimensioni (øxH): 305x32 mm</p> 	<p>China white round rim soup plate Materiale: New Bone China</p> <p>CW1102024 Dimensioni (øxH): 240 mm</p> <p>CW1102027 Dimensioni (øxH): 260 mm</p> <p>CW1102131 Dimensioni (øxH): 305 mm</p> 	<p>China white SHOW PLATE Materiale: New Bone China</p> <p>CW1103033 Dimensioni (øxH): 320x16 mm</p> 
<p>China white round coupe plate Materiale: New Bone China</p> <p>CW1201015 Dimensioni (øxH): 145x20 mm</p> <p>CW1201017 Dimensioni (øxH): 165x22 mm</p> <p>CW1201019 Dimensioni (øxH): 195x25 mm</p> <p>CW1201022 Dimensioni (øxH): 215x28 mm</p> <p>CW1201024 Dimensioni (øxH): 240x27 mm</p> <p>CW1201027 Dimensioni (øxH): 265x30 mm</p> <p>CW1201031 Dimensioni (øxH): 310x35 mm</p> <p>CW1201036 Dimensioni (øxH): 355x37 mm</p> <p>CW1201042 Dimensioni (øxH): 415x43 mm</p> 	<p>China white deep round coupe plate Materiale: New Bone China</p> <p>CW1202022 Dimensioni (øxH): 225x44 mm Capacità: 667 ml</p> <p>CW1202027 Dimensioni (øxH): 265x43 mm Capacità: 809 ml</p> <p>CW1202032 Dimensioni (øxH): 320x50 mm Capacità: 1450 ml</p> <p>CW1202037 Dimensioni (øxH): 360x56 mm Capacità: 2091 ml</p> 	<p>China white oval rim plate Materiale: New Bone China</p> <p>CW1301027 Dimensioni (LxPxH): 265x185x23 mm Capacità: 145 ml</p> <p>CW1301031 Dimensioni (LxPxH): 2305x215x27 mm Capacità: 230 ml</p> <p>CW1301037 Dimensioni (LxPxH): 365x270x31 mm Capacità: 293 ml</p> <p>CW1301042 Dimensioni (LxPxH): 420x315x46 mm Capacità: 882 ml</p> 
<p>China white oval coupe plate Materiale: New Bone China</p> <p>CW1302025 Dimensioni (LxPxH): 240x170x27 mm Capacità: 351 ml</p> <p>CW1302029 Dimensioni (LxPxH): 275x110x31 mm Capacità: 445 ml</p> <p>CW1302033 Dimensioni (LxPxH): 325x230x36 mm Capacità: 767 ml</p> <p>CW1302038 Dimensioni (LxPxH): 380x285x40 mm Capacità: 1215 ml</p> 	<p>China white coppa cereali Materiale: New Bone China</p> <p>CW1603013 Dimensioni (øxH): 130x41 mm Capacità: 242 ml</p> 	<p>China white coppetta Materiale: New Bone China</p> <p>CW1601009 Dimensioni (øxH): 90x45 mm Capacità: 137 ml</p> <p>CW1601010 Dimensioni (øxH): 100x44 mm Capacità: 138 ml</p> <p>CW1601011 Dimensioni (øxH): 110x50 mm Capacità: 175 ml</p> <p>CW1601012 Dimensioni (øxH): 115x53 mm Capacità: 218 ml</p> <p>CW1601013 Dimensioni (øxH): 125x55 mm Capacità: 271 ml</p> 



<p>China white espresso cup zen Materiale: New Bone China Piatto non incluso CW1408207 Dimensioni (LxPxH): 85x65x67 mm Capacità: 71 ml Compatibile con: CW1416112, CW1431015, EL3405113</p> 	<p>China white tea cup zen Materiale: New Bone China Piatto non incluso CW1408221 Dimensioni (LxPxH): 125x90x93 mm Capacità: 220 ml Compatibile con: CW1415616, CW1431021, EL3405119</p> 	<p>China white mug zen Materiale: New Bone China Piatto non incluso CW1408230 Dimensioni (LxPxH): 135x100x113 mm Capacità: 297 ml Compatibile con: CW1415616, CW1431021, EL3405119</p> 
<p>China white cone mug Materiale: New Bone China CW2002029 Dimensioni (LxPxH): 110x80x102 mm Capacità: 250 ml Compatibile con: CW1415417</p> 	<p>China white straight mug Materiale: New Bone China CW2001428 Dimensioni (øxH): 78x91 mm Capacità: 247 cl</p> 	<p>China white rectangular saucer Materiale: New Bone China CW1431015 Dimensioni (LxPxH): 150x100x19 mm Compatibile con: CW1408207 CW1431021 Dimensioni (LxPxH): 210x145x26 mm Compatibile con: CW1408221, CW1408230</p> 
<p>China white coupe saucer Materiale: New Bone China CW1415112 Dimensioni (ø): 120 mm Compatibile con: CW1406009 CW1415115 Dimensioni (ø): 150 mm Compatibile con: CW1406020, CW1407028</p> 	<p>China white coupe saucer Materiale: New Bone China CW1415412 Dimensioni (ø): 110 mm Compatibile con: CW1407111 CW1415416 Dimensioni (ø): 150 mm Compatibile con: CW1407124 CW1415417 Dimensioni (ø): 160 mm Compatibile con: CW1407133, CW2002029</p> 	<p>China white coupe saucer Materiale: New Bone China CW1415612 Dimensioni (øxH): 115x18 mm Compatibile con: CW1408207</p> 

China white insalatiera

Materiale: New Bone China

CW1603016

Dimensioni (øxH): 160x56 mm
Capacità: 506 ml

CW1604019

Dimensioni (øxH): 190x70 mm
Capacità: 740 ml

CW1604023

Dimensioni (øxH): 230x84 mm
Capacità: 1471 ml



China white tazza brodo

Materiale: New Bone China

Piatto non incluso

CW1501128

Dimensioni (LxPxH): 155x105x96 mm
Capacità: 232 ml



China white tazza brodo

Materiale: New Bone China

Piatto non incluso

CW1501028

Dimensioni (LxPxH): 120x100x94 mm
Capacità: 229 ml



China white espresso cup stakable

Materiale: New Bone China

Piatto non incluso

CW1406009

Dimensioni (LxPxH): 80x65x44 mm

Capacità: 71 ml

Compatibile con: CW1415112



China white tea cup stakable

Materiale: New Bone China

Piatto non incluso

CW1406020

Dimensioni (LxPxH): 110x85x57 mm

Capacità: 167 ml

Compatibile con: CW1415115



China white cappuccino cup

Materiale: New Bone China

Piatto non incluso

CW1407028

Dimensioni (LxPxH): 130x110x62 mm

Capacità: 273 ml

Compatibile con: CW1415115



China whitea espresso cup AK

Materiale: New Bone China

Piatto non incluso

CW1407111

Dimensioni (LxPxH): 90x70x49 mm

Capacità: 86 ml

Compatibile con: CW1415412



China white tea cup AK

Materiale: New Bone China

Piatto non incluso

CW1407124

Dimensioni (LxPxH): 115x90x61 mm

Capacità: 184 ml

Compatibile con: CW1415416



China white tazza colazione AK

Materiale: New Bone China

Piatto non incluso

CW1407133









Dimensioni (LxPxH): 125x100x70 mm

Capacità: 249 ml

Compatibile con: CW1415417



<p>China white coupe saucer Materiale: New Bone China CW1415616 Dimensioni (øxH): 160 mm Compatibile con: CW1408221, CW1408230</p> 	<p>China white coupe saucer Materiale: New Bone China EL3405113 Dimensioni (LxP): 130 x110 mm Compatibile con: CW1408207</p> 	<p>China white coupe saucer Materiale: New Bone China EL3405119 Dimensioni (LxP): 185 x155 mm Compatibile con: CW1408221, CW1408230</p> 
<p>China white tea pot Materiale: New Bone China CW1702045 Dimensioni (LxPxH): 175x105x100 mm Capacità: 426 ml CW1702075 Dimensioni (LxPxH): 210x120x118 mm Capacità: 705 ml</p> 	<p>China white coffee pot Materiale: New Bone China CW1703038 Dimensioni (LxPxH): 155x90x112 mm Capacità: 400 ml CW1703080 Dimensioni (LxPxH): 200x120x135 mm Capacità: 800 ml</p> 	<p>China white creamer Materiale: New Bone China CW1801005 Dimensioni (LxPxH): 80x45x49 mm Capacità: 40 ml CW1801009 Dimensioni (LxPxH): 105x60x60 mm Capacità: 95 ml CW1801022 Dimensioni (LxPxH): 130x75x80 mm Capacità: 200 ml</p> 
<p>China white marmalade and sugar pot Materiale: New Bone China Piatto non incluso CW1707124S Dimensioni (øxH): 90x82 mm Capacità: 200 ml Compatibile con: CW1707124U CW1707124M Dimensioni (øxH): 90x82 mm Capacità: 200 ml Compatibile con: CW1707124U</p> 	<p>China white marmalade and sugar pot underliner Materiale: New Bone China CW1707124U Dimensioni (LxPxH): 215x125x21 mm Compatibile con: CW1707124S, CW1707124M</p> 	<p>China white toothpick holder Materiale: New Bone China CW1804005 Dimensioni (øxH): 35x49 mm</p> 

<p>China white sachet holder Materiale: New Bone China</p> <p>CW1707010 Dimensioni (LxPxH): 95x70x54 mm Capacità: 145 ml Compatibile con: CW1808014</p> 	<p>China white sachet holder underliner Materiale: New Bone China</p> <p>CW1808014 Dimensioni (LxPxH): 170x105x20 mm Compatibile con: CW1707010</p> 	<p>New bone china mini casseruola Materiale: New Bone China</p> <p>CW1502818 Dimensioni (LxPxH): 180x160x97 mm Capacità: 196 ml</p> <p>CW1502821 Dimensioni (LxPxH): 210x190x98 mm Capacità: 253 ml</p> <p>CW1502825 Dimensioni (LxPxH): 250x230x110 mm Capacità: 314 ml</p> 
<p>China white salt and pepper shaker Materiale: New Bone China</p> <p>CW1706008S Dimensioni (H): 80 mm</p> <p>CW1706008P Dimensioni (H): 80 mm</p> 	<p>China white gravy boat Materiale: New Bone China</p> <p>CW1704012 Capacità: 120 ml</p> <p>CW1704040 WHILE STOCK LAST Dimensioni (LxPxH): 215x80x88 mm Capacità: 372 ml</p> 	<p>China white gravy boat underliner Materiale: New Bone China</p> <p>CW1704012U Dimensioni (L): 160 mm</p> <p>CW1704040U WHILE STOCK LAST Dimensioni (L): 215 mm</p> 
<p>China white egg cup Materiale: New Bone China</p> <p>CW1807006 Dimensioni (øxH): 55x58 mm Capacità: 31 ml</p> 	<p>China white marmalade spoon Materiale: New Bone China</p> <p>CW1802010 Dimensioni (LxPxH): 80x30x65 mm Compatibile con: CW1707124M</p> 	<p>China white chinese spoon Materiale: New Bone China</p> <p>CW1802113 Dimensioni (LxPxH): 130x45x53 mm</p> 



China white bud vase

Materiale: New Bone China

CW1805114

Dimensioni (øxH): 65x141 mm



Miniature mini pentolini per salse

Materiale: Porcelain

CW2601107

Dimensioni (LxPxH): 105x65x26 mm

Capacità: 23 ml



Miniature mini tegami quadrati

Materiale: Porcelain

CW2601210

Dimensioni (LxPxH): 95x70x36 mm

Capacità: 85 ml





Miniature mini vascelli

Materiale: Porcelain

CW2603011

Dimensioni (LxPxH): 115x65x39 mm

Capacità: 65 ml



Miniature mini bowls affusolate quadrate

Materiale: Porcelain

LG6071007-WH

Dimensioni (LxPxH): 70x70x36 mm

Capacità: 50 ml



Miniature mini bowls per antipasto monoporzione

Materiale: Porcelain

LG6075006-WH

Dimensioni (LxPxH): 95x95x70 mm

Capacità: 18 ml





**Miniature mini bowls per assaggio
monoporzione**

Materiale: Porcelain

LG6076007-WH

Dimensioni (LxPxH): 85x65x60 mm

Capacità: 47 ml



Miniature piattino quadrato basso

Materiale: Porcelain

LG6072008

Dimensioni (LxPxH): 80x80x24 mm

Capacità: 60 ml



Miniature pickle dish

Materiale: Porcelain

LG6074010 **WHILE STOCK LAST**

Dimensioni (LxPxH): 95x90x37 mm

Capacità: 62 ml



EVOLUTION



Evolution oval plate

Materiale: New Bone China

EL3401019

Dimensioni (LxPxH): 185x155x30 mm

EL3401022

Dimensioni (LxPxH): 225x185x31 mm

EL3401029

Dimensioni (LxPxH): 290x245x47 mm

EL3401036

Dimensioni (LxPxH): 360x290x44 mm



Evolution piatto fondo

Materiale: New Bone China

EL3402023

Dimensioni (LxPxH): 230x180x57 mm

Capacità: 634 ml

EL3402027

Dimensioni (LxPxH): 270x190x60 mm

Capacità: 740 ml



Evolution insalatiera

Materiale: New Bone China

EL3403016

Dimensioni (LxPxH): 155x145x69 mm

Capacità: 408 ml

EL3403019

Dimensioni (LxPxH): 190x170x84 mm

Capacità: 716 ml

EL3403028

Dimensioni (LxPxH): 270x240x98 mm

Capacità: 1817 ml

EL3403013

Dimensioni (LxPxH): 130x120x56 mm

Capacità: 238 ml





Evolution espresso cup

Materiale: New Bone China

EL3405010

Dimensioni (LxPxH): 100x80x49 mm
Capacità: 92 ml

Evolution coupe saucer

Materiale: New Bone China

EL3405113

Dimensioni (LxPxH): 130x110x21 mm



Evolution tea cup

Materiale: New Bone China

EL3405218

Dimensioni (LxPxH): 115x95x55 mm
Capacità: 188 ml

EL3405225

Dimensioni (LxPxH): 135x115x63 mm
Capacità: 207 ml

Evolution coupe saucer

Materiale: New Bone China

EL3405119

Dimensioni (LxPxH): 185x155x30 mm



Evolution tazza colazione

Materiale: New Bone China

EL3405040

Dimensioni (LxPxH): 155x125x76 mm
Capacità: 315 ml

Evolution coupe saucer

Materiale: New Bone China

EL3405119









Dimensioni (LxPxH): 185x155x30 mm









<p>Evolution tea cup con manico aperto Materiale: New Bone China EL3405425 Dimensioni (LxPxH): 145x110x67 mm Capacità: 216 ml</p> <p>Evolution coupe saucer Materiale: New Bone China EL3405119 Dimensioni (LxPxH): 185x155x30 mm</p> 	<p>Evolution tea pot Materiale: New Bone China EL3408102 Dimensioni (LxPxH): 215x130x130 mm Capacità: 871 ml</p> 	<p>Evolution creamer Materiale: New Bone China EL3408010 Dimensioni (LxPxH): 100x60x65 mm Capacità: 82 ml</p> <p>EL3408027 Dimensioni (LxPxH): 135x85x90 mm Capacità: 224 ml</p> 
<p>Evolution zuccheriera Materiale: New Bone China EL3413005 Dimensioni (øxH): 50x53 mm Capacità: 34ml</p> 	<p>Evolution sugar pot con coperchio Materiale: New Bone China EL3407019 Dimensioni (LxPxH): 110x105x71 mm Capacità: 167 ml</p> 	<p>Evolution coppetta Materiale: New Bone China EL3403008 Dimensioni (LxPxH): 80x80x50 mm Capacità: 82 ml</p> <p>EL3403012 Dimensioni (LxPxH): 115x110x67 mm Capacità: 218 ml</p> 
<p>Evolution salt shaker Materiale: New Bone China EL3411003S Dimensioni (LxPxH): 55x50x34 mm</p> 	<p>Evolution pepper shaker Materiale: New Bone China EL3411003P Dimensioni (LxPxH): 55x50x34 mm</p> 	

CONCORD



Concord square plate

Materiale: New Bone China

CC3001016

Dimensioni (LxPxH): 160x160x24 mm

CC3001020

Dimensioni (LxPxH): 210x210x28 mm

CC3001024

Dimensioni (LxPxH): 245x245x32 mm

CC3001028

Dimensioni (LxPxH): 285x285x40 mm



Concord rectangular plate

Materiale: New Bone China

CC3003032

Dimensioni (LxPxH): 320x230x36 mm











Concord pasta plate

Materiale: New Bone China

CC3002029

Dimensioni (LxPxH): 285x290x50 mm



<p>Concord piatto fondo Concord Materiale: New Bone China CC3002022 Dimensioni (LxPxH): 220x220x55 mm Capacità: 704 ml</p> 	<p>Concord insalatiera Materiale: New Bone China CC3005012 Dimensioni (LxPxH): 120x120x52 mm Capacità: 204 ml CC3005017 Dimensioni (LxPxH): 165x165x60 mm Capacità: 469 ml CC3005024 Dimensioni (LxPxH): 240x240x80 mm Capacità: 1204 ml</p> 	<p>Concord mini bowls per dessert Materiale: New Bone China MG6105226 Dimensioni (øxH): 100x66 mm Capacità: 208 ml</p> 
<p>Concord espresso cup Materiale: New Bone China CC3006010 Dimensioni (LxPxH): 100x80x44 mm Capacità: 79 ml</p> <p>Concord coupe saucer Materiale: New Bone China CC3006112 Dimensioni (øxH): 120x18 mm</p> 	<p>Concord tea cup Materiale: New Bone China CC3006016 Dimensioni (LxPxH): 115x95x51 mm Capacità: 145 ml</p> <p>Concord coupe saucer Materiale: New Bone China CC3006115 Dimensioni (øxH): 145x22 mm</p> 	<p>Concord colazione Materiale: New Bone China CC3006023 Dimensioni (LxPxH): 130x105x54 mm Capacità: 197 ml</p> <p>Concord coupe saucer Materiale: New Bone China CC3006116 Dimensioni (øxH): 160x23 mm</p> 
<p>Concord coffee pot Materiale: New Bone China CC3010058 Dimensioni (LxPxH): 180x100x136 mm Capacità: 478 ml</p> 	<p>Concord tea pot Materiale: New Bone China CC3009054 Dimensioni (LxPxH): 220x135x102 mm Capacità: 446 ml</p> 	<p>Concord creamer Materiale: New Bone China CC3008015 Dimensioni (LxPxH): 130x85x60 mm Capacità: 111 ml</p> 

HARMONY



Harmony square plate

Materiale: New Bone China

HW1108015

Dimensioni (LxPxH): 150x150x21 mm

HW1108020

Dimensioni (LxPxH): 200x200x26 mm

HW1108026

Dimensioni (LxPxH): 265x265x33 mm



Harmony rectangular plate

Materiale: New Bone China

HW1108126

Dimensioni (LxPxH): 265x175x23 mm











Harmony rectangular plate

Materiale: New Bone China











HW1108131

Dimensioni (LxPxH): 305x205x29 mm



<p>Harmony piatto quadro curvo Materiale: New Bone China</p> <p>HW1107012 Dimensioni (LxPxH): 130x130x25 mm</p> <p>AK6111018 Dimensioni (LxPxH): 180x180x27 mm</p> <p>AK6111024 Dimensioni (LxPxH): 240x240x45 mm</p> 	<p>Harmony piatto rettangolare curvo Materiale: New Bone China</p> <p>HW1301035 Dimensioni (LxPxH): 355x260x40 mm Capacità: 1097 ml</p> 	<p>Harmony oval plate fondo Materiale: New Bone China</p> <p>HW1105127 Dimensioni (LxPxH): 265x150x58 mm Capacità: 751 ml</p> <p>HW1105131 Dimensioni (LxPxH): 305x180x62 mm Capacità: 1097 ml</p> 
<p>Harmony piatto rettangolare Materiale: New Bone China</p> <p>HW1108247 Dimensioni (LxPxH): 470x165x24 mm</p> 	<p>Harmony rettangolare Materiale: New Bone China</p> <p>HW1209328 Dimensioni (LxPxH): 295x210x145 mm Capacità: 776 ml</p> 	<p>Harmony oblong Materiale: New Bone China</p> <p>HW3000111 Dimensioni (LxPxH): 110x80x43 mm Capacità: 44 ml</p> <p>HW3000114 Dimensioni (LxPxH): 140x95x92 mm Capacità: 92 ml</p> 
<p>Harmony pointed Materiale: New Bone China</p> <p>HW3000211 Dimensioni (LxPxH): 110x110x41 mm Capacità: 40 ml</p> <p>HW3000214 Dimensioni (LxPxH): 140x130x52 mm Capacità: 85 ml</p> 	<p>Harmony chord Materiale: New Bone China</p> <p>HW3000011 Dimensioni (LxPxH): 110x95x43 mm Capacità: 47 ml</p> <p>HW3000014 Dimensioni (LxPxH): 140x120x52 mm Capacità: 91 ml</p> 	<p>Harmony square Materiale: New Bone China</p> <p>HW3000311 Dimensioni (LxPxH): 80x80x43 mm Capacità: 41 ml</p> <p>HW3000314 Dimensioni (LxPxH): 100x100x52 mm Capacità: 94 ml</p> 



<p>MG piatto mg Materiale: New Bone China</p> <p>MG1101017 Dimensioni (øxH): 165x18 mm</p> <p>MG1101021 Dimensioni (øxH): 210x19 mm</p> <p>MG1101027 Dimensioni (øxH): 270x22 mm</p> <p>MG1101031 Dimensioni (øxH): 305x27 mm</p>  <p>FALDA TESA FLAT RIM</p>  <p>GRAN GOURMET DESIGN</p>	<p>MG piatto flair ala alta Materiale: New Bone China</p> <p>MG6101017 Dimensioni (øxH): 175x22 mm</p> <p>MG6101024 Dimensioni (øxH): 235x27 mm</p> <p>MG6101027 Dimensioni (øxH): 270x31 mm</p> <p>MG6101029 Dimensioni (øxH): 285x32 mm</p>  <p>ALA ALTA SLANTING RIM</p> 	<p>MG piatto pasta "flat" Materiale: New Bone China</p> <p>IV1401030 Dimensioni (øxH): 305 mm</p> 
<p>MG piatto pasta "hat" Materiale: New Bone China</p> <p>IV1403028 Dimensioni (øxH): 280x66 mm Capacità: 212 ml</p> 	<p>MG piatto flair fondo ala alta Materiale: New Bone China</p> <p>MG6102023 Dimensioni (øxH): 230x41 mm Capacità: 597 ml</p> 	<p>MG bowl flair Materiale: New Bone China</p> <p>MG6103016 Dimensioni (øxH): 160x61 mm Capacità: 597 ml</p> <p>MG6103027 Dimensioni (øxH): 275x68 mm Capacità: 1261 ml</p> 
<p>MG piatto rettangolare MG Materiale: New Bone China</p> <p>MG1107139 Dimensioni (LxPxH): 390x280x27 mm</p> 	<p>MG piatto quadrato MG Materiale: New Bone China</p> <p>MG1107030 Dimensioni (LxPxH): 305x305x25 mm</p> 	<p>MG piatto antipasto Materiale: New Bone China</p> <p>IV1402131 Dimensioni (LxPxH): 305x305x21 mm</p> 

SIGNATURE





Piatto Signature

Materiale: New Bone China

CW1208932

Dimensioni (DxH): 308x29 mm

CW1208926

Dimensioni (DxH): 271x29 mm



Piatto fondo Signature

Materiale: New Bone China

CW1206024

Dimensioni (LxH): 242x55 mm



Bowl Signature

Materiale: New Bone China

CW1220018

Dimensioni (DxH): 175x77 mm





Signature piatto signature

Materiale: New Bone China

IV1127030

Dimensioni (LxPxH): 305x305x46 mm



Signature piatto signature

Materiale: New Bone China

IV1127037

Dimensioni (LxPxH): 370x285x50 mm



TATE COLLECTION



Tate square slate plate

Materiale: New Bone China

HW4207018-H

Dimensioni (LxPxH): 180x180x13 mm

HW4207026-H

Dimensioni (LxPxH): 260x260x14 mm



Tate square slate plate

Materiale: New Bone China

HW4207018

Dimensioni (LxPxH): 180x180x13 mm

HW4207026

Dimensioni (LxPxH): 260x260x14 mm



Tate rectangular slate plate

Materiale: New Bone China

HW4207233-H

Dimensioni (LxPxH): 330x240x12 mm



Tate rectangular slate plate

Materiale: New Bone China

HW4207233

Dimensioni (LxPxH): 330x240x12 mm



OYSTER



Piatto coupe Oyster

Materiale: New Bone China

OT1101027RB

Dimensioni (øxH): 270x24 mm



Piatto coupe Oyster

Materiale: New Bone China

OT1101027RG

Dimensioni (øxH): 270x24 mm



Soup plate Oyster
Materiale: New Bone China

OT6102021RB
Dimensioni (øxH): 210x45 mm
OT6102023RB
Dimensioni (øxH): 230x51 mm
OT6102026RB
Dimensioni (øxH): 258x59 mm



Soup plate Oyster
Materiale: New Bone China

OT6102021RG
Dimensioni (øxH): 210x45 mm
OT6102023RG
Dimensioni (øxH): 230x51 mm
OT6102026RG
Dimensioni (øxH): 258x59 mm



Piatto piano Oyster
Materiale: New Bone China

OT6110021RB
Dimensioni (øxH): 212x27 mm
OT6110023RB
Dimensioni (øxH): 234x27 mm
OT6110027RB
Dimensioni (øxH): 274x33 mm
OT6110031RB
Dimensioni (øxH): 308x40 mm



Piatto piano Oyster
Materiale: New Bone China

OT6110021RG
Dimensioni (øxH): 212x27 mm
OT6110023RG
Dimensioni (øxH): 234x27 mm
OT6110027RG
Dimensioni (øxH): 274x33 mm
OT6110031RG
Dimensioni (øxH): 308x40 mm



Bowl Oyster
Materiale: New Bone China

OT6120024RB
Dimensioni (øxH): 240x67 mm
OT6120029RB
Dimensioni (øxH): 290x80 mm



Bowl Oyster
Materiale: New Bone China

OT6120024RG
Dimensioni (øxH): 240x67 mm
OT6120029RG
Dimensioni (øxH): 290x80 mm



Bowl Oyster
Materiale: New Bone China

OT6122018RB
Dimensioni (øxH): 180x75 mm
OT6122023RB
Dimensioni (øxH): 228x98 mm



Bowl Oyster
Materiale: New Bone China

OT6122018RG
Dimensioni (øxH): 180x75 mm
OT6122023RG
Dimensioni (øxH): 228x98 mm





Complementi tavola



The Stainless steel Coffee Pot is built with double wall for heat insulation.
Lid can be open at 180° making it easier to fill up and can be cleaned in the dishwasher.
All of our Coffee Pots are made from 18/10 stainless steel.





COFFEE & TEA POTS



Tea pot (500 ml)

Material: Stainless steel 18-10

Code: 10140-000

Package: 12 ea

Size: L60 × W151.2 × H174.5 mm

Weight: 0.45 kg

Capacity: 0.5 Ltr



Tea pot (900 ml)

Material: Stainless steel 18-10

Code: 10150-000

Package: 12 ea

Size: L60 × W157.3 × H274.5 mm

Weight: 0.69 kg

Capacity: 0.9 Ltr



Coffee pot (1200 ml)

Material: Stainless steel 18-10

Code: 10160-000

Package: 12 ea

Size: L80 × W184.7 × H231 mm

Weight: 0.7 kg

Capacity: 1.2 Ltr



Coffee pot (1500 ml)

Material: Stainless steel 18-10

Code: 10170-000

Package: 12 ea

Size: L80 × W185.5 × H276 mm

Weight: 0.83 kg

Capacity: 1.5 Ltr



Sugar bowl (200 ml)

Material: Stainless steel 18-10

Code: 10180-000

Package: 12 ea

Size: L60 × W94.1 × H65 mm

Weight: 0.16 kg

Capacity: 0.2 Ltr



Milk jug (150 ml)

Material: Stainless steel 18-10

Code: 10210-000

Package: 12 ea

Size: L40 × W102.7 × H117.4 mm

Weight: 0.2 kg

Capacity: 0.15 Ltr



WATER PITCHERS



Water pitcher (1500 ml)
Material: Stainless steel 18-10
Code: 10190-000
Package: 12 ea
Size: L80 × W186 × H253 mm
Weight: 1.05 kg
Capacity: 1.5 Ltr



Water pitcher (1500 ml)
Material: Stainless steel 18-10
Code: 10190-000-RGD (rose gold) ON REQUEST
Package: 12 ea
Size: L80 × W186 × H253 mm
Weight: 1.05 kg
Capacity: 1.5 Ltr



Water pitcher (2000 ml)
Material: Stainless steel 18-10
Code: 10200-000
Package: 12 ea
Size: L80 × W175 × H320 mm
Weight: 1.15 kg
Capacity: 2.0 Ltr



Water pitcher (2000 ml)
Material: Stainless steel 18-10
Code: 10200-000-RGD (rose gold) ON REQUEST
Package: 12 ea
Size: L80 × W175 × H320 mm
Weight: 1.15 kg
Capacity: 2.0 Ltr



Water pitcher (single, 2000 ml)
Material: Stainless steel 18-10
Code: 10130-000
Package: 12 ea
Size: L106 × W164.8 × H250.2 mm
Weight: 0.7 kg
Capacity: 2 Ltr



Water pitcher (double, 1500 ml)
Material: Stainless steel 18-10
Code: 10230-000
Package: 12 ea
Size: L106 × W164.8 × H250.2 mm
Weight: 1.14 kg
Capacity: 1.5 Ltr



DOUBLE WALL COFFEE POTS & THERMOS

The lid can completely open till 180°.

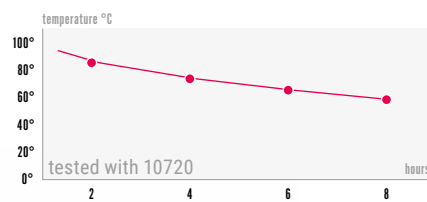
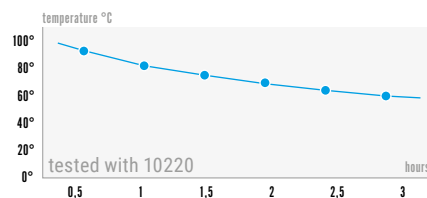

Double wall coffee pot (300 ml)

Material: Stainless steel 18-10; Solid die casting; ABS (chrome plated); Silicone

Code: 10120-RVS

Package: 12 ea
Size: L132 x W100.4 x H187 mm
Weight: 0.49 kg
Capacity: 0.3 Ltr



Double wall coffee pot (600 ml)

Material: Stainless steel 18-10; Solid die casting; ABS (chrome plated); Silicone

Code: 10220-RVS

Package: 12 ea
Size: L132 x W100.4 x H212 mm
Weight: 0.57 kg
Capacity: 0.6 Ltr



Double wall coffee pot (950 ml)

Material: Stainless steel 18-10; Solid die casting; ABS (chrome plated); Silicone

Code: 10320-RVS

Package: 12 ea
Size: L132 x W100.4 x H239 mm
Weight: 0.64 kg
Capacity: 0.95 Ltr



Double wall coffee pot (1200 ml)

Material: Stainless steel 18-10; Solid die casting; ABS (chrome plated); Silicone

Code: 10420-RVS

Package: 12 ea
Size: L155.6 x W116.5 x H255.4 mm
Weight: 0.82 kg
Capacity: 1.2 Ltr



Double wall coffee pot (1500 ml)

Material: Stainless steel 18-10; Solid die casting; ABS (chrome plated); Silicone

Code: 10520-RVS

Package: 12 ea
Size: L155.6 x W116.5 x H268.7 mm
Weight: 0.89 kg
Capacity: 1.5 Ltr



Vacuum thermo (400 ml)

Material: Stainless steel 18-10; Solid die casting handle

Code: 10620-000

Package: 12 ea
Size: L185 x W112 x H180 mm
Weight: 0.72 kg
Capacity: 0.4 Ltr



Vacuum thermo (700 ml)

Material: Stainless steel 18-10; Solid die casting handle

Code: 10720-000

Package: 12 ea
Size: L188 x W112 x H200 mm
Weight: 0.82 kg
Capacity: 0.7 Ltr



Vacuum thermo (1000 ml)

Material: Stainless steel 18-10; Solid die casting handle

Code: 10820-000

Package: 12 ea
Size: L195 x W130 x H205 mm
Weight: 0.9 kg
Capacity: 1 Ltr



Vacuum thermo (1500 ml)

Material: Stainless steel 18-10; Solid die casting handle

Code: 10920-000

Package: 12 ea
Size: L200 x W130 x H235 mm
Weight: 1.2 kg
Capacity: 1.5 Ltr



WINE COOLERS



Smiley ice bucket

Material: Stainless steel 18-10; PMMA (Acrylic)

Code: 40003-000

With ice tong

Size: D145 × H258.5 mm

Weight: 0.82 kg

Capacity: 1.7 Ltr



Smiley ice bucket

Material: Stainless steel 18-10; PMMA (Acrylic)

Code: 40003-000-RGD (rose gold) ON REQUEST

With ice tong

Size: D145 × H258.5 mm

Weight: 0.82 kg

Capacity: 1.7 Ltr



Smiley wine bucket

Material: Stainless steel 18-10

Code: 40004-000

Size: D180 × H210 mm

Weight: 1.07 kg

Capacity: 5 Ltr





Smiley wine bucket

Material: Stainless steel 18-10

Code: 40004-000-RGD (rose gold) **ON REQUEST**

Size: D180 × H210 mm

Weight: 1.07 kg

Capacity: 5 Ltr



Ice tong with bottle opener

Material: Stainless steel 18-10

Code: 40007-000

Size: L15 × W33.4 × H167.5 mm

Weight: 0.05 kg



Smiley wine bucket stand

Material: Stainless steel 18-10; Aluminium alloys (chrome plated)

Code: 40012-000

Size: D270 × H606 mm

Weight: 3.37 kg

Compatible with: 40004-000





Ice bucket with double wall

Material: Stainless steel 18-10

Code: 11600-000

Size: D170 × H198 mm

Weight: 0.7 kg

Capacity: 0.94 Ltr



Double wall ice bucket with acrylic lid

Material: Stainless steel 18-10; PMMA (Acrylic)

Code: 11600-200

Size: D165 × H150 mm

Weight: 0.7 kg

Capacity: 1.2 Ltr



Thimble wine cooler

Material: Stainless steel 18-10

Code: 40006-000

Size: D250 × H200 mm

Weight: 1.65 kg

Capacity: 4.7 Ltr



Inset for ice

Material: PMMA (Acrylic)

Code: 40005-100

Size: D144.5 × 120 mm

Weight: 0.23 kg



Thimble ice bucket with ice tong

Material: Stainless steel 18-10; PMMA (Acrylic)

Code: 40005-000

Size: D197 × H265.5 mm

Weight: 1.19 kg

Capacity: 1.7 Ltr



Thimble w/ table wire hook

Material: Stainless steel 18-10; Silicone

Code: 40008-000

Size: L198 × W380.6 × H109.8 mm

Weight: 0.65 kg

Compatible with: 40006-000



Thimble wine bucket stand

Material: Stainless steel 18-10; Aluminium alloys (chrome plated); PMMA (Acrylic)

Code: 40013-000

Size: D270 × H609 mm

Weight: 3.32 kg

Compatible with: 40006-000





Thimble punch bowl (20 Ltr)

Material: Stainless steel 18-10

Code: 40009-000

Size: D455 × H250 mm

Weight: 4.08 kg

Capacity: 20 Ltr



Punch bowl

Material: Stainless steel 18-10

Code: 11610-000

Size: D446 × H276 mm

Weight: 2.2 kg

Capacity: 20 Ltr

Code: 11611-000

Size: D375 × H247.5 mm

Weight: 1.64 kg

Capacity: 14 Ltr





Manhattan wine ice bucket

Material: Stainless steel 18-10 (PVD coated & glass bead sanding), PMMA (Acrylic)

Code: 40010-000

Size: L140 × W180 × H275.5 mm

Weight: 1.61 kg

Capacity: 2.6 Ltr



Manhattan wine grotto

Material: Stainless steel 18-10 (PVD coated & glass bead sanding)

Code: 40011-000

Size: L150 × W340 × H200 mm

Weight: 3.14 kg

Capacity: 8.6 Ltr



OTHERS



Smiley single flower vase

Material: Stainless steel 18-10; PMMA (Acrylic)

Code: 40001-100

Size: D38 x H143 mm

Weight: 0.16 kg

Code: 40001-200

Size: D38 x H193 mm

Weight: 0.2 kg



Smiley single candle holder

Material: Stainless steel 18-10; PMMA (Acrylic)

Code: 40001-300

Size: D38 x H143 mm

Weight: 0.16 kg



Smiley single flower vase

Material: Stainless steel 18-10

Code: 40002-100

Size: D89.1 x H243 mm

Weight: 0.5 kg

Code: 40002-200

Size: D89.1 x H293 mm

Weight: 0.62 kg







S.S. bread basket

Material: Stainless steel 18-10

Code: 40018-100

Size: L220 x W220 x H39 mm

Weight: 0.33 kg

Code: 40018-100-RGD (rose gold) ON REQUEST

Size: L220 x W220 x H39 mm

Weight: 0.33 kg

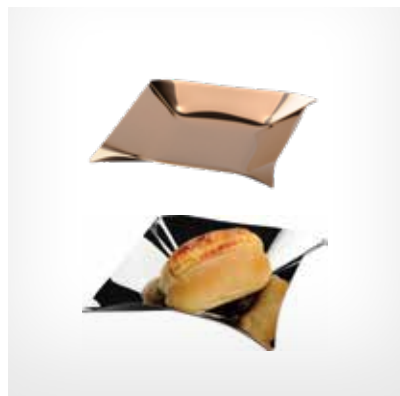

S.S. bread basket

Material: Stainless steel 18-10

Code: 40018-200

Size: L284 x W186 x H44 mm

Weight: 0.53 kg

Code: 40018-200-RGD (rose gold) ON REQUEST

Size: L284 x W186 x H44 mm

Weight: 0.53 kg



S.S. bread basket

Material: Stainless steel 18-10

Code: 40018-300

Size: L285 x W140 x H39 mm

Weight: 0.45 kg

Code: 40018-300-RGD (rose gold) ON REQUEST

Size: L285 x W140 x H39 mm

Weight: 0.45 kg



S.S. bread basket

Material: Stainless steel 18-10

Code: 40018-400

Size: L240 x W240 x H39 mm

Weight: 0.51 kg

Code: 40018-400-RGD (rose gold) ON REQUEST

Size: L240 x W240 x H39 mm

Weight: 0.51 kg



Manhattan square tray

Material: Stainless steel 18-10

Code: 19007-100

Size: L340 x W340 x H30 mm

Weight: 1.4 kg

Code: 19007-100-RGD (rose gold) ON REQUEST

Size: L340 x W340 x H30 mm

Weight: 1.4 kg



Manhattan square tray

Material: Stainless steel 18-10

Code: 19007-200

Size: L450 x W450 x H30 mm

Weight: 2.3 kg



Manhattan oblong tray
 Material: Stainless steel 18-10
Code: 19007-300
 Size: L365 x W185 x H20 mm
 Weight: 0.8 kg



Manhattan jam holder
 Material: Stainless steel 18-10
Code: 19007-400
 Size: L180 x W50 x H20 mm
 Weight: 0.14 kg



Manhattan tea holder
 Material: Stainless steel 18-10
Code: 19007-500
 Size: L115 x W65 x H40 mm
 Weight: 0.17 kg

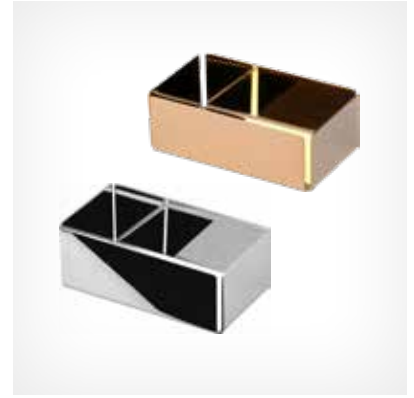

Code: 19007-400-RGD (rose gold) ON REQUEST
 Size: L180 x W50 x H20 mm
 Weight: 0.14 kg

Code: 19007-500-RGD (rose gold) ON REQUEST
 Size: L115 x W65 x H40 mm
 Weight: 0.17 kg

Manhattan sugar bag holder
 Material: Stainless steel 18-10
Code: 19007-600
 Size: L65 x W65 x H40 mm
 Weight: 0.14 kg



Oil & vinegar set
 Material: Stainless steel 18-10; Borosilicate glass
Code: 40020-000
 Size: L170 x W80 x H282 mm
 Weight: 1.1 kg
 Capacity: Oil&Veneqar Glass 0.2 Ltr
 Salt&Pepper Glass 0.04 Ltr



Jam Stand
 Material: Stainless steel 18-10
Code: 40026-000
 Size: L116.4 x W126 x H200 mm
 Weight: 0.2 kg



BREAD BASKET

Bread baskets are a must for your table... and can be a plus for your buffet!

Our baskets are made of an eco leather with a pure cotton liner.

100% made in Italy.

The cotton liner is certified for food contact and it is pre-washed.

Baskets are washing machine safe!

Special colors and sizes available on request.



Ecoleather bread basket burgundy color
Materiale: Eco-leather, antibacterial cotton washing machine safe

CP10VINO
Dimensioni (ø): ø10 cm
CP14VINO
Dimensioni (ø): ø14 cm
CP5x10VINO
Dimensioni (LxP): 5x10 cm
CP11x11VINO
Dimensioni (LxP): 11x11 cm



Ecoleather bread basket pearl color
Materiale: Eco-leather, antibacterial cotton washing machine safe

CP10PERL
Dimensioni (ø): ø10 cm
CP14PERL
Dimensioni (ø): ø14 cm
CP5x10PERL
Dimensioni (LxP): 5x10 cm
CP11x11PERL
Dimensioni (LxP): 11x11 cm



Ecoleather bread basket black color
Materiale: Eco-leather, antibacterial cotton washing machine safe

CP10NERO
Dimensioni (ø): ø10 cm
CP14NERO
Dimensioni (ø): ø14 cm
CP5x10NERO
Dimensioni (LxP): 5x10 cm
CP11x11NERO
Dimensioni (LxP): 11x11 cm



Ecoleather bread basket brown color
Materiale: Eco-leather, antibacterial cotton washing machine safe

CP10MARR
Dimensioni (ø): 10 cm
CP14MARR
Dimensioni (ø): 14 cm
CP5x10MARR
Dimensioni (LxP): 5x10 cm
CP11x11MARR
Dimensioni (LxP): 11x11 cm















Cutlery











Posate dalla linea moderna ed essenziale.
Realizzate in acciaio inox 18/10.











SCHOTT

<p>Cucchiaino tavola Fleurie Materiale: Stainless steel 18-10 FLEU 011 Dimensioni: 209 mm</p> 	<p>Forchetta tavola Fleurie Materiale: Stainless steel 18-10 FLEU 021 Dimensioni: 207 mm</p> 	<p>Coltello tavola Fleurie Materiale: Stainless steel 18-10 FLEU 111 Dimensioni: 236 mm</p> 	<p>Cucchiaino thè Fleurie Materiale: Stainless steel 18-10 FLEU 302 Dimensioni: 140 mm</p> 
<p>Cucchiaino dessert Fleurie Materiale: Stainless steel 18-10 FLEU 012 Dimensioni: 182 mm</p> 	<p>Forchetta dessert Fleurie Materiale: Stainless steel 18-10 FLEU 022 Dimensioni: 184 mm</p> 	<p>Coltello dessert Fleurie Materiale: Stainless steel 18-10 FLEU 113 Dimensioni: 212 mm</p> 	<p>Cucchiaino moka Fleurie Materiale: Stainless steel 18-10 FLEU 307 Dimensioni: 110 mm</p> 
<p>Coltello carne Fleurie Materiale: Stainless steel 18-10 FLEU 115 Dimensioni: 235 mm</p> 	<p>Coltello pesce Fleurie Materiale: Stainless steel 18-10 FLEU 124 Dimensioni: 199 mm</p> 		











<p>Cucchiaino tavola Livorno 3,5 mm Materiale: Stainless steel 18-10 LIVO 011 Dimensioni: 205 mm</p> 	<p>Forchetta tavola Livorno 3,5 mm Materiale: Stainless steel 18-10 LIVO 021 Dimensioni: 205 mm</p> 	<p>Coltello tavola Livorno 3,5 mm Materiale: Stainless steel 18-10 LIVO 112 Dimensioni: 245 mm</p> 	<p>Cucchiaino tè Livorno 3,5 mm Materiale: Stainless steel 18-10 LIVO 302 Dimensioni: 130 mm</p> 
<p>Cucchiaino dessert Livorno 3,5 mm Materiale: Stainless steel 18-10 LIVO 012 Dimensioni: 178 mm</p> 	<p>Forchetta dessert Livorno 3,5 mm Materiale: Stainless steel 18-10 LIVO 022 Dimensioni: 183 mm</p> 	<p>Coltello dessert Livorno 3,5 mm Materiale: Stainless steel 18-10 LIVO 114 Dimensioni: 220 mm</p> 	<p>Cucchiaino moka Livorno 3,5 mm Materiale: Stainless steel 18-10 LIVO 307 Dimensioni: 120 mm</p> 



<p>Cucchiaino tavola Lotus Materiale: Stainless steel 18-10 LOTU 011 Dimensioni: 209 mm</p> 	<p>Forchetta tavola Lotus Materiale: Stainless steel 18-10 LOTU 021 Dimensioni: 208 mm</p> 	<p>Coltello tavola Lotus Materiale: Stainless steel 18-10 LOTU 112 Dimensioni: 227 mm</p> <p>Coltello tavola Lotus LOTU 100 Dimensioni: 235 mm</p> 	<p>Cucchiaino thè Lotus Materiale: Stainless steel 18-10 LOTU 302 Dimensioni: 128 mm</p> 
<p>Cucchiaino dessert Lotus Materiale: Stainless steel 18-10 LOTU 012 Dimensioni: 189 mm</p> 	<p>Forchetta dessert Lotus Materiale: Stainless steel 18-10 LOTU 022 Dimensioni: 188 mm</p> 	<p>Coltello dessert Lotus Materiale: Stainless steel 18-10 LOTU 114 Dimensioni: 214 mm</p> 	<p>Cucchiaino moka Lotus Materiale: Stainless steel 18-10 LOTU 307 Dimensioni: 107 mm</p> 











<p>Cucchiaino tavola Constance Materiale: Chrome steel 18-0 CONS 011 Dimensioni: 203 mm</p> 	<p>Forchetta tavola Constance Materiale: Chrome steel 18-0 CONS 021 Dimensioni: 197 mm</p> 	<p>Coltello tavola Constance Materiale: Stainless steel 18-10 CONS 111 Dimensioni: 211 mm</p> 	<p>Cucchiaino moka Constance Materiale: Chrome steel 18-0 CONS 307 Dimensioni: 110 mm</p> 
<p>Cucchiaino dessert Constance Materiale: Chrome steel 18-0 CONS 012 Dimensioni: 188 mm</p> 	<p>Forchetta dessert Constance Materiale: Chrome steel 18-0 CONS 022 Dimensioni: 185 mm</p> 	<p>Coltello dessert Constance Materiale: Chrome steel 18-0 CONS 114 Dimensioni: 198 mm</p> 	<p>Coltello carne Constance Materiale: Chrome steel 18-0 CONS 110 Dimensioni: 236 mm</p> 









Coltello carne Eclipse
 Materiale: Stainless steel 18-10
ECLI 115
 Dimensioni: 236 mm



<p>Cucchiaino tavola Eclipse Materiale: Stainless steel 18-10 ECLI 011 Dimensioni: 209 mm</p> 	<p>Forchetta tavola Eclipse Materiale: Stainless steel 18-10 ECLI 021 Dimensioni: 211 mm</p> 	<p>Coltello tavola Eclipse Materiale: Stainless steel 18-10 ECLI 112 Dimensioni: 240 mm</p> 	<p>Cucchiaino thè Eclipse Materiale: Stainless steel 18-10 ECLI 302 Dimensioni: 133 mm</p> 
<p>Cucchiaino dessert Eclipse Materiale: Stainless steel 18-10 ECLI 012 Dimensioni: 189 mm</p> 	<p>Forchetta dessert Eclipse Materiale: Stainless steel 18-10 ECLI 022 Dimensioni: 190 mm</p> 	<p>Coltello dessert Eclipse Materiale: Stainless steel 18-10 ECLI 114 Dimensioni: 211 mm</p> 	<p>Cucchiaino moka Eclipse Materiale: Stainless steel 18-10 ECLI 307 Dimensioni: 111 mm</p> 











<p>Cucchiaino tavola Hermitage Materiale: Stainless steel 18-10 HERM 011 Dimensioni: 216 mm</p> 	<p>Forchetta tavola Hermitage Materiale: Stainless steel 18-10 HERM 021 Dimensioni: 215 mm</p> 	<p>Coltello tavola Hermitage Materiale: Stainless steel 18-10 HERM 112 Dimensioni: 237 mm</p> 	<p>Cucchiaino moka Hermitage Materiale: Stainless steel 18-10 HERM 307 Dimensioni: 111 mm</p> 
<p>Cucchiaino dessert Hermitage Materiale: Stainless steel 18-10 HERM 012 Dimensioni: 186 mm</p> 	<p>Forchetta dessert Hermitage Materiale: Stainless steel 18-10 HERM 022 Dimensioni: 188 mm</p> 	<p>Coltello dessert Hermitage Materiale: Stainless steel 18-10 HERM 114 Dimensioni: 222 mm</p> 	<p>Coltello carne Hermitage Materiale: Stainless steel 18-10 HERM 110 Dimensioni: 239 mm</p> 









Coltello carne Ibiza
 Materiale: Chrome steel 18-0
IBIZ 115
 Dimensioni: 233 mm











<p>Cucchiaino tavola Ibiza Materiale: Chrome steel 18-0 IBIZ 011 Dimensioni: 208 mm</p> 	<p>Forchetta tavola Ibiza Materiale: Chrome steel 18-0 IBIZ 021 Dimensioni: 211 mm</p> 	<p>Coltello tavola Ibiza Materiale: Chrome steel 18-0 IBIZ 112 Dimensioni: 237 mm</p> 	<p>Cucchiaino thè Ibiza Materiale: Chrome steel 18-0 IBIZ 302 Dimensioni: 130 mm</p> 
<p>Cucchiaino dessert Ibiza Materiale: Chrome steel 18-0 IBIZ 012 Dimensioni: 187 mm</p> 	<p>Forchetta dessert Ibiza Materiale: Chrome steel 18-0 IBIZ 022 Dimensioni: 188 mm</p> 	<p>Coltello dessert Ibiza Materiale: Chrome steel 18-0 IBIZ 114 Dimensioni: 213 mm</p> 	<p>Cucchiaino moka Ibiza Materiale: Chrome steel 18-0 IBIZ 307 Dimensioni: 113 mm</p> 











<p>Cucchiaino tavola Lausanne Materiale: Stainless steel 18-10 LAUS 011 Dimensioni: 206 mm</p> 	<p>Forchetta tavola Lausanne Materiale: Stainless steel 18-10 LAUS 021 Dimensioni: 208 mm</p> 	<p>Coltello tavola Lausanne Materiale: Stainless steel 18-10 LAUS 112 Dimensioni: 230 mm</p> 	<p>Coltello carne Lausanne Materiale: Stainless steel 18-10 LAUS 115 Dimensioni: 232 mm</p> 
<p>Cucchiaino dessert Lausanne Materiale: Stainless steel 18-10 LAUS 012 Dimensioni: 186 mm</p> 	<p>Forchetta dessert Lausanne Materiale: Stainless steel 18-10 LAUS 022 Dimensioni: 187 mm</p> 	<p>Coltello dessert Lausanne Materiale: Stainless steel 18-10 LAUS 114 Dimensioni: 199 mm</p> 	



<p>Cucchiaino tavola Lima Materiale: Stainless steel 18-10 LIMA 011 Dimensioni: 206 mm</p> 	<p>Forchetta tavola Lima Materiale: Stainless steel 18-10 LIMA 021 Dimensioni: 208 mm</p> 	<p>Coltello tavola Lima Materiale: Stainless steel 18-10 LIMA 112 Dimensioni: 237 mm</p> 	<p>Cucchiaino moka Lima Materiale: Stainless steel 18-10 LIMA 307 Dimensioni: 112 mm</p> 
<p>Cucchiaino dessert Lima Materiale: Stainless steel 18-10 LIMA 012 Dimensioni: 190 mm</p> 	<p>Forchetta dessert Lima Materiale: Stainless steel 18-10 LIMA 022 Dimensioni: 191 mm</p> 	<p>Coltello dessert Lima Materiale: Stainless steel 18-10 LIMA 114 Dimensioni: 206 mm</p> 	<p>Coltello carne Lima Materiale: Stainless steel 18-10 LIMA 115 Dimensioni: 233 mm</p> 











<p>Cucchiaio tavola Montreal Materiale: Stainless steel 18-10 MONT 011 Dimensioni: 210 mm</p> 	<p>Forchetta tavola Montreal Materiale: Stainless steel 18-10 MONT 021 Dimensioni: 207 mm</p> 	<p>Coltello tavola Montreal Materiale: Stainless steel 18-10 MONT 111 Dimensioni: 236 mm</p> 	<p>Coltello carne Montreal Materiale: Stainless steel 18-10 MONT 117 Dimensioni: 235 mm</p> 
<p>Cucchiaio dessert Montreal Materiale: Stainless steel 18-10 MONT 012 Dimensioni: 182 mm</p> 	<p>Forchetta dessert Montreal Materiale: Stainless steel 18-10 MONT 022 Dimensioni: 186 mm</p> 	<p>Coltello dessert Montreal Materiale: Stainless steel 18-10 MONT 113 Dimensioni: 217 mm</p> 	<p>Coltello pesce Montreal Materiale: Stainless steel 18-10 MONT 124 Dimensioni: 216 mm</p> 











Coltello carne Luxor
 Materiale: Stainless steel 18-10
LUXO 110
 Dimensioni: 230 mm











<p>Cucchiaio tavola Luxor Materiale: Stainless steel 18-10 LUXO 011 Dimensioni: 209 mm</p> 	<p>Forchetta tavola Luxor Materiale: Stainless steel 18-10 LUXO 021 Dimensioni: 206 mm</p> 	<p>Coltello tavola Luxor Materiale: Stainless steel 18-10 LUXO 111 Dimensioni: 237 mm</p> 	<p>Cucchiaino thè Luxor Materiale: Stainless steel 18-10 LUXO 302 Dimensioni: 130 mm</p> 
<p>Cucchiaio dessert Luxor Materiale: Stainless steel 18-10 LUXO 012 Dimensioni: 194 mm</p> 	<p>Forchetta dessert Luxor Materiale: Stainless steel 18-10 LUXO 022 Dimensioni: 194 mm</p> 	<p>Coltello dessert Luxor Materiale: Stainless steel 18-10 LUXO 113 Dimensioni: 215 mm</p> 	<p>Cucchiaio moka Luxor Materiale: Stainless steel 18-10 LUXO 307 Dimensioni: 110 mm</p> 









<p>Cucchiaino tavola Siena Materiale: Stainless steel 18-10 SIEN 011 Dimensioni: 206 mm</p> 	<p>Forchetta tavola Siena Materiale: Stainless steel 18-10 SIEN 021 Dimensioni: 207 mm</p> 	<p>Coltello tavola Siena Materiale: Stainless steel 18-10 SIEN 112 Dimensioni: 237 mm</p> <p>Coltello carne Siena SIEN 115 Dimensioni: 237 mm</p> 	<p>Cucchiaino thè Siena Materiale: Stainless steel 18-10 SIEN 302 Dimensioni: 133 mm</p> 
<p>Cucchiaino dessert Siena Materiale: Stainless steel 18-10 SIEN 012 Dimensioni: 187 mm</p> 	<p>Forchetta dessert Siena Materiale: Stainless steel 18-10 SIEN 022 Dimensioni: 188 mm</p> 	<p>Coltello dessert Siena Materiale: Stainless steel 18-10 SIEN 114 Dimensioni: 211 mm</p> 	<p>Cucchiaino moka Siena Materiale: Stainless steel 18-10 SIEN 307 Dimensioni: 111 mm</p> 



<p>Cucchiaino tavola Twist Materiale: Stainless steel 18-10 TWIS 011 Dimensioni: 209 mm</p> 	<p>Forchetta tavola Twist Materiale: Stainless steel 18-10 TWIS 021 Dimensioni: 211 mm</p> 	<p>Coltello tavola Twist Materiale: Stainless steel 18-10 TWIS 112 Dimensioni: 240 mm</p> <p>Coltello carne Twist TWIS 115 Dimensioni: 240 mm</p> 	<p>Cucchiaino thè Twist Materiale: Stainless steel 18-10 TWIS 302 Dimensioni: 133 mm</p> 
<p>Cucchiaino dessert Twist Materiale: Stainless steel 18-10 TWIS 012 Dimensioni: 187 mm</p> 	<p>Forchetta dessert Twist Materiale: Stainless steel 18-10 TWIS 022 Dimensioni: 188 mm</p> 	<p>Coltello dessert Twist Materiale: Stainless steel 18-10 TWIS 113 Dimensioni: 211 mm</p> 	<p>Cucchiaino moka Twist Materiale: Stainless steel 18-10 TWIS 307 Dimensioni: 111 mm</p> 



<p>Cucchiaio tavola Windsor Materiale: Stainless steel 18-10 WIND 011 Dimensioni: 204 mm</p> 	<p>Forchetta tavola Windsor Materiale: Stainless steel 18-10 WIND 021 Dimensioni: 208 mm</p> 	<p>Coltello tavola Windsor Materiale: Stainless steel 18-10 WIND 111 Dimensioni: 245 mm</p> 	<p>Coltello carne Windsor Materiale: Stainless steel 18-10 WIND 115 Dimensioni: 237 mm</p> 
<p>Cucchiaio dessert Windsor Materiale: Stainless steel 18-10 WIND 012 Dimensioni: 177 mm</p> 	<p>Forchetta dessert Windsor Materiale: Stainless steel 18-10 WIND 022 Dimensioni: 183 mm</p> 	<p>Coltello dessert Windsor Materiale: Stainless steel 18-10 WIND 113 Dimensioni: 225 mm</p> 	



Coltello bistecca

Materiale: Wood, Stainless steel 18-10



STEAK241

Dimensioni: 241 mm

Table mats

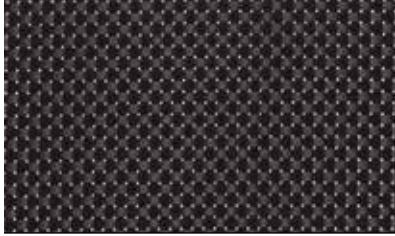

Made of PVC are ideal for breakfast A business lunch set up.

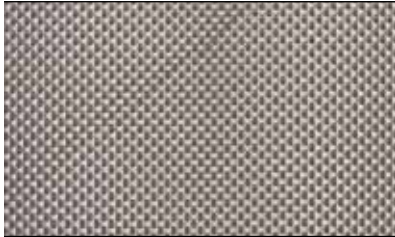
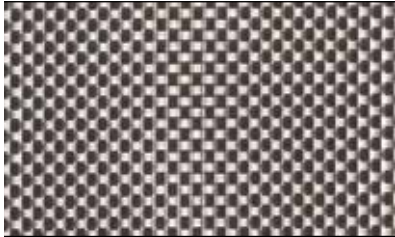
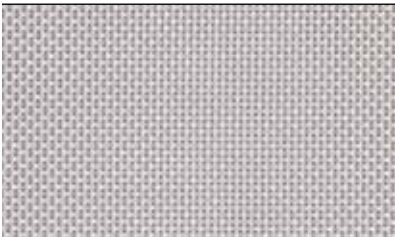
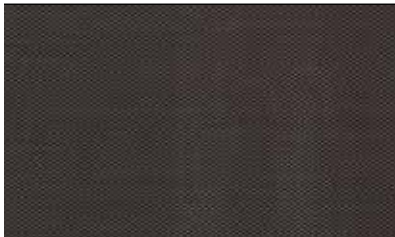
<p>Table mat Materiale: PVC TOV-SPA 418 Confezione: 12 pz Misura (LxH): 300x400 mm</p> 	<p>Table mat Materiale: PVC TOV-SPA 803 Confezione: 12 pz Misura (LxH): 300x400 mm</p> 	<p>Table mat Materiale: PVC TOV-SPA 02 Confezione: 12 pz Misura (LxH): 300x400 mm</p> 
<p>Table mat Materiale: PVC TOV-SPA 04 Confezione: 12 pz Misura (LxH): 300x400 mm</p> 	<p>Table mat Materiale: PVC TOV-SPA 406 Confezione: 12 pz Misura (LxH): 300x400 mm</p> 	<p>Table mat Materiale: PVC TOV-SPA 801 Confezione: 12 pz Misura (LxH): 300x400 mm</p> 
<p>Table mat Materiale: PVC TOV-SPA 404 Confezione: 12 pz Misura (LxH): 300x400 mm</p> 	<p>Table mat Materiale: PVC TOV-SPA 01 Confezione: 12 pz Misura (LxH): 300x400 mm</p> 	

happy hour



Le lattine

UNDERGROUND FASHION





Lattina rotonda grande
Materiale: Acciaio

1803
Dimensioni: 65H x 100Ø
Capacità: 429 ml



Lattina rotonda media
Materiale: Acciaio

1802
Dimensioni: 59H x 75Ø
Capacità: 210 ml



Lattina rotonda piccola
Materiale: Acciaio

1801
Dimensioni: 37H x 73Ø
Capacità: 117 ml



Lattina ovale
Materiale: Acciaio

1800
Dimensioni: 113L x 73P x 28H
Capacità: 150 ml





Street food

TRENDY SULLA STRADA









Scatola kraft aperta

Materiale: Kraft

1216

Dimensioni: 130L x 100P x 40H

1217

Dimensioni: 150L x 125P x 40H

1218

Dimensioni: 240L x 160P x 50H



Cono News

Materiale: Carta antigrasso

1221

Dimensioni: 150L x 145P

1222

Dimensioni: 210L x 205P



Foglio News food

Materiale: Carta antigrasso

1220

Dimensioni: 420L x 297P



Foglio News food

Materiale: Carta antigrasso

1482-P

Dimensioni: 330L x 278P

Compatibile con: 1482

1481-P

Dimensioni: 303L x 244P

Compatibile con: 1482

1480-P

Dimensioni: 245L x 155P

Compatibile con: 1482





Scatola + Coperchio finestrato

Materiale: Kraft

1209

Dimensioni: L100 x P100 x H40

Capacità: 350 ml

1210

Dimensioni: L120 x P120 x H45

Capacità: 500 ml

1211

Dimensioni: L140 x P140 x H50

Capacità: 700 ml

1212

Dimensioni: L180 x P180 x H40

Capacità: 1000 ml





Cocktail

PER RENDERE OGNI EVENTO UN GRANDE MOMENTO







Espositore 14 o 21 fori
Materiale: PET

PC2 2X7

Dimensioni: 600L x 120P

Compatibile con: CONO240;CONO185;CONO125;CONO85

PC2 3X7

Dimensioni: 630L x 210P

Compatibile con: CONO240;CONO185;CONO125;CONO85



Cono
Materiale: Legno

CONO240

Dimensioni: 240L

Compatibile con: S09-1374PC

CONO185

Dimensioni: 185L

Compatibile con: S09-1374PC

CONO125

Dimensioni: 125L

Compatibile con: S09-1374PC

CONO85

Dimensioni: 85L

Compatibile con: S09-1374PC



Porta coni
Materiale: Bamboo

S09-1374PC

Dimensioni: 130L x 130P

Compatibile con: CONO240;CONO185;CONO125;CONO85



Forchettina
Materiale: Bamboo

FOR90

Dimensioni: 90L

CUC90

Dimensioni: 90L

FOR90BLACK

Dimensioni: 90L

CUC90BLACK

Dimensioni: 90L



Cucchiaio in foglia di bamboo
Materiale: Bamboo

CFB130

Dimensioni: 130L



Mini forchettina
Materiale: Bamboo

CBFK90

Dimensioni: 90L



Molla in bamboo
Materiale: Bamboo

BTONG13

Dimensioni: 130L



Stick a petalo
Materiale: Bamboo

STICKPETAL

Dimensioni: 80L x 50P











Stick arricciato bicolor
Materiale: Bamboo

STICKRICTORS

Dimensioni: 80L



<p>Stick in salice Materiale: Legno</p> <p>KUR90 Dimensioni: 90L</p> <p>KUR120 Dimensioni: 120L</p> 	<p>Stick con ricciolo Materiale: Bamboo</p> <p>STICKR105 Dimensioni: 105L</p> <p>STICKR150 Dimensioni: 150L</p> <p>STICKR180 Dimensioni: 180L</p> 	<p>Stick piatto Materiale: Bamboo</p> <p>STICKP105 Dimensioni: 105L</p> <p>STICKP150 Dimensioni: 150L</p> <p>STICKP180 Dimensioni: 180L</p> 
<p>Piattino rettangolare Materiale: Legno</p> <p>OBLONG140 Dimensioni: 140L x 80P</p> 	<p>Piattino quadrato con falda Materiale: Legno</p> <p>SQUARE100 Dimensioni: 100L x 100P</p> <p>SQUARE80 Dimensioni: 80L x 80P</p> <p>SQUARE60 Dimensioni: 60L x 60P</p> 	<p>Minibowl Materiale: Legno</p> <p>MBFB8020 Dimensioni: 20H x 80Ø</p> 
<p>Mini vassoio Materiale: Bamboo</p> <p>MV80X50 Dimensioni: 80L x 50P</p> 	<p>Minipiatto intrecciato rotondo Materiale: Legno</p> <p>MO054 Dimensioni: 60Ø</p> 	<p>Minipiatto intrecciato quadrato Materiale: Legno</p> <p>MO053 Dimensioni: 55L x 55P</p> 

Barchetta

Materiale: Legno

BARC7X5

Dimensioni: 70L x 50P

BARC11X6

Dimensioni: 110L x 60P

BARC14X7

Dimensioni: 140L x 70P

BARC17X8

Dimensioni: 170L x 80P

BARC22X11

Dimensioni: 220L x 110P



Bicchierino legno

Materiale: Legno

CUP45X45

Dimensioni: 45H x 45Ø

Capacità: 70 ml

CUP60X60

Dimensioni: 60H x 60Ø

Capacità: 160 ml



Tronco bamboo grande taglio obliquo

Materiale: Bamboo

S09-1370

Dimensioni: 90H x 45Ø

Capacità: 135 ml



Tronco bamboo piccolo

Materiale: Bamboo

S09-1369

Dimensioni: 50H x 45Ø

Capacità: 75 ml



Minipiatto

Materiale: Bamboo

MP35X35

Dimensioni: 35L x 35P

MP50X50

Dimensioni: 50L x 50P



Bicchiere in bamboo

Materiale: Bamboo

BIC45X72

Dimensioni: 72H x 45Ø

Capacità: 100 ml

BIC45X52

Dimensioni: 52H x 45Ø

Capacità: 80 ml



Cucchiaino forchetta di legno
Materiale: Legno

CFB160
Dimensioni: 160L



Cucchiaino di legno
Materiale: Legno

CGB160
Dimensioni: 160L



Coltello di legno
Materiale: Legno

CB160
Dimensioni: 160L



Forchetta di legno
Materiale: Legno

FB160
Dimensioni: 160L





Vasetto yoghurt

Materiale: Vetro

1600

Dimensioni: 67H x 52Ø

1600/T

Dimensioni: 52Ø



Bottiglietta con tappo in sughero

Materiale: Vetro

1602

Dimensioni: 103H x 22Ø

Capacità: 70 ml

1602/t

Dimensioni: 15H x 12Ø



Vasetto da conserva

Materiale: Vetro

1601

Dimensioni: 66H x 52Ø

Capacità: 140 ml

1601/t

Dimensioni: 52Ø





Uovo in porcellana
Materiale: Porcellana

2100023
Dimensioni: 100H x 80Ø
2100022
Dimensioni: 50H x 50Ø



Vasetto terracotta
Materiale: Terracotta

2203006
Dimensioni: 90H x 100Ø



Vasetto meccanico in vetro
Materiale: Vetro

GL101B
Dimensioni: 118H x 68Ø
GL101C
Dimensioni: 70H x 55Ø
GL101
Dimensioni: 85H x 42Ø
GL101A
Dimensioni: 63H x 42Ø
GL113
Dimensioni: 55H x 45Ø



Mini Limo
Materiale: Vetro

MLM11
Dimensioni: 140H x 45Ø
Capacità: 110 ml



Mini teglia rame
Materiale: Rame

S6301-1
Dimensioni: 140L



Mini teglia
Materiale: Inox

S6301
Dimensioni: 140L



Mini secchiello rame
Materiale: Rame

S6310-1
Dimensioni: 90Ø



Mini Secchiello
Materiale: Inox

S6310
Dimensioni: 90Ø



Mini stock rame
Materiale: Rame

S6304-1
Dimensioni: 90Ø



Mini stock
Materiale: Acciaio

S6304
Dimensioni: 90Ø



Mini casseruola rame
Materiale: Rame

S6302-1
Dimensioni: 70Ø



Mini casseruola
Materiale: Acciaio

S6302
Dimensioni: 70Ø



Mini padella
Materiale: Acciaio

S6303
Dimensioni: 100Ø



Mini wok
Materiale: Acciaio

S6305
Dimensioni: 115Ø



Tappo chiuso per ampolla
Materiale: Alluminio

CAPS23
Dimensioni: 30H x 27Ø
Compatibile con: FAG100;FAG250



Tappo aperto per ampolla
Materiale: Alluminio

CAPS22
Dimensioni: 23H x 27Ø
Compatibile con: FAG100;FAG250



Ampolla tipo lampadina vetro
Materiale: Vetro

FAG100
Dimensioni: 95H x 60Ø
Capacità: 100 ml
Compatibile con: CAPS22;CAPS23

FAG250
Dimensioni: 120H x 75Ø
Capacità: 250 ml
Compatibile con: CAPS22;CAPS23



Dispositivo spray per flacone squadrato
Materiale: PS

SPR12
Compatibile con: FS121



Tappo alluminio per flacone squadrato

Materiale: Alluminio

BA11

Compatibile con: FS120



Flacone squadrato

Materiale: Vetro

FS120

Dimensioni: 32L x 32P x 166H

Capacità: 120 ml

Compatibile con: BA11;SPR12





Cup with food collection

Materiale: Glasses

1058

Dimensioni: Ø58 x H103

Capacità: 190 ml

1099

Dimensioni: Ø71 x Ø40 x H90

Capacità: 100 ml

1097

Capacità: 40 ml

Dimensioni: Ø33 x Ø31 x H63



Bicchieri stropicciato bianco

Materiale: PS

1060B

Dimensioni: 65H x 78Ø

Capacità: 80 ml



Bicchieri stropicciato nero

Materiale: PS

1060N

Dimensioni: 65H x 78Ø

Capacità: 80 ml



Bicchieri stropicciato trasparente

Materiale: PS

1061T

Dimensioni: 50H x 60Ø

Capacità: 180 ml

1060T

Dimensioni: 65H x 78Ø

Capacità: 80 ml



Coppa Joanna impilabile

Materiale: PS

1075

Dimensioni: 80H x 73 41Ø

Capacità: 200 ml

1075/T

Dimensioni: 73Ø



Vasetto PET yoghurt

Materiale: PS

1079

Dimensioni: 70H x 55Ø

Capacità: 180 ml



Stick polipropilene

Materiale: Polipropilene

PRISM90

Dimensioni: 90L

Capacità: 90 ml

PRISM90BL

Dimensioni: 90L





Kit chiusura Kilix
Materiale: PS

1072
Dimensioni: 3H x 73Ø



Vasetto Kilix grande
Materiale: PS

1071
Dimensioni: 100H x 55Ø
Capacità: 140 ml



Vasetto Kilix piccolo
Materiale: PS

1070
Dimensioni: 55H x 55Ø
Capacità: 80 ml



Vasetto ermetico
Materiale: PS

1033
Dimensioni: 63H x 106Ø
Capacità: 300 ml





Vassoi e piatti

UNA VASTA GAMMA DI VASSOI DI DIVERSI MATERIALI,
FUNZIONALITÀ E DESIGN



Vassoio rettangolare da esposizione

Materiale: Melamina

P22085

Dimensioni: 390L x 150P

P22086

Dimensioni: 500L x 180P



Piatto rotondo da presentazione

Materiale: Melamina

P22090

Dimensioni: 20H x 310Ø



Vassoio rettangolare con sponda alta

Materiale: Melamina

P22091

Dimensioni: 250L x 150P x 65H

P22092

Dimensioni: 305L x 220P x 25H



Ciotola snack o salse

Materiale: Melamina

P22930

Dimensioni: 92L x 69P x 31H



Vassoio rettangolare

Materiale: Melamina

P22940

Dimensioni: 234L x 147P



Ciotola conica

Materiale: Melamina

P22167

Dimensioni: 85H x 130Ø

Compatibile con: P22158

P22168

Dimensioni: 108H x 160Ø

Compatibile con: P22158



Alzatina tonda doppia faccia Granito - Bamboo

Materiale: Melamina

P22144

Dimensioni: 330Ø

P22145

Dimensioni: 430Ø



Pala da forno con manico effetto ardesia

Materiale: Melamina

P22670

Dimensioni: 320L x 230Ø

P22671

Dimensioni: 430L x 300Ø

P22672

Dimensioni: 530L x 380Ø











Paniere tondo con manico

Materiale: Melamina

P22650

Dimensioni: 300Ø



<p>Pala da forno con manico Materiale: Melamina</p> <p>P22651 Dimensioni: 530L x 200P</p> <p>P22652 Dimensioni: 610L x 200P</p> 	<p>Vassoio effetto legno Materiale: Melamina</p> <p>P22620 Dimensioni: 300L x 150P</p> <p>P22621 Dimensioni: 300L x 200P</p> <p>P22622 Dimensioni: 400L x 300P</p> 	<p>Alzatina presentazione effetto legno Materiale: Melamina</p> <p>P22600 Dimensioni: 530L x 325P</p> <p>P22601 Dimensioni: 325L x 265P</p> <p>P22602 Dimensioni: 325L x 176P</p> <p>P22603 Dimensioni: 265L x 162P</p> <p>P22604 Dimensioni: 530L x 165P</p> <p>P22605 Dimensioni: 500L x 250P</p> <p>P22606 Dimensioni: 250L x 150P</p> 
<p>Alzatina effetto ardesia nero Materiale: Melamina</p> <p>P22640N Dimensioni: 325L x 265P</p> <p>P22641N Dimensioni: 325L x 175P</p> <p>P22642N Dimensioni: 265L x 160P</p> 	<p>Alzatina effetto ardesia bianco Materiale: Melamina</p> <p>P22640B Dimensioni: 325L x 265P</p> <p>P22641B Dimensioni: 325L x 175P</p> <p>P22642B Dimensioni: 265L x 160P</p> 	<p>Alzatina presentazione nero Materiale: Melamina</p> <p>P22610N Dimensioni: 530L x 325P</p> <p>P22611N Dimensioni: 325L x 265P</p> <p>P22612N Dimensioni: 325L x 176P</p> <p>P22613N Dimensioni: 265L x 162P</p> <p>P22614N Dimensioni: 530L x 165P</p> <p>P22615N Dimensioni: 500L x 250P</p> <p>P22616N Dimensioni: 250L x 150P</p> 
<p>Alzatina presentazione bianco Materiale: Melamina</p> <p>P22610B Dimensioni: 530L x 325P</p> <p>P22611B Dimensioni: 325L x 265P</p> <p>P22612B Dimensioni: 325L x 176P</p> <p>P22613B Dimensioni: 265L x 162P</p> <p>P22614B Dimensioni: 530L x 165P</p> <p>P22615B Dimensioni: 500L x 250P</p> <p>P22616B Dimensioni: 250L x 150P</p> 	<p>Alzatina doppia faccia Granito - Ardesia Materiale: Melamina</p> <p>P22161 Dimensioni: 530L x 325P</p> <p>P22162 Dimensioni: 325L x 265P</p> 	



Mini casseruola alta ovale con coperchio
Materiale: Fusione in ferro

P23509

Dimensioni: 125L x 93P x 75H
Capacità: 250 ml



Mini casseruola ovale
Materiale: Fusione in ferro

P23508

Dimensioni: 215L x 155P x 65H
Capacità: 600 ml



Mini casseruola alta con coperchio
Materiale: Fusione in ferro

P23507

Dimensioni: 95H x 140Ø
Capacità: 700 ml



Mini casseruola ovale con coperchio
Materiale: Fusione in ferro

P23506

Dimensioni: 120L x 80P x 50H



Mini casseruola con coperchio
Materiale: Fusione in ferro

P23505

Dimensioni: 130L x 75H x 100Ø
Capacità: 200 ml



Mini sarten rettangolare
Materiale: Fusione in ferro

P23504

Dimensioni: 180L x 127P



Mini padella quadrata
Materiale: Fusione in ferro

P23503

Dimensioni: 233L x 136P x 36H



Mini padella alta
Materiale: Fusione in ferro

P23502

Dimensioni: 235L x 28H x 140Ø



Mini padella
Materiale: Fusione in ferro

P23501

Dimensioni: 210L x 25H x 135Ø



Mini padella

Materiale: Fusione in ferro

P23500

Dimensioni: 160L x 28H x 105Ø



Mini casseruola bassa

Materiale: Alluminio

P151016

Dimensioni: 50H x 160Ø
Capacità: 800 ml



Mini casseruola alta

Materiale: Alluminio

P151012

Dimensioni: 85H x 120Ø
Capacità: 750 ml

P151014

Dimensioni: 85H x 140Ø
Capacità: 1.000 ml



Mini Casserola coperchio Bianco

Materiale: Melamina

P23806

Dimensioni: 65H x 100Ø
Capacità: 250 ml

P23816

Dimensioni: 80H x 140Ø
Capacità: 750 ml



Mini Casserola coperchio Fuxia

Materiale: Melamina

P23805

Dimensioni: 65H x 100Ø
Capacità: 250 ml

P23815

Dimensioni: 80H x 140Ø
Capacità: 750 ml



Mini Casserola coperchio Arancione

Materiale: Melamina

P23804

Dimensioni: 65H x 100Ø
Capacità: 250 ml

P23814

Dimensioni: 80H x 140Ø
Capacità: 750 ml



Mini Casserola coperchio Verde

Materiale: Melamina

P23803

Dimensioni: 65H x 100Ø
Capacità: 250 ml

P23813

Dimensioni: 80H x 140Ø
Capacità: 750 ml



Mini Casserola coperchio Tortora

Materiale: Melamina

P23802

Dimensioni: 65H x 100Ø
Capacità: 250 ml

P23812

Dimensioni: 80H x 140Ø
Capacità: 750 ml



Mini Casserola coperchio Marrone

Materiale: Melamina

P23801

Dimensioni: 65H x 100Ø
Capacità: 250 ml

P23811

Dimensioni: 80H x 140Ø
Capacità: 750 ml



Mini Casserola coperchio Nero
Materiale: Melamina

P23800

Dimensioni: 65H x 100Ø
Capacità: 250 ml

P23810

Dimensioni: 80H x 140Ø
Capacità: 750 ml



Mini secchiello
Materiale: Acciaio

P24407

Dimensioni: 35H x 75Ø
Capacità: 150 ml

P24409

Dimensioni: 85H x 90Ø
Capacità: 320 ml



Mini padella con manico
Materiale: Acciaio

P24500

Dimensioni: 152L x 16H x 80Ø
Capacità: 80 ml

P24501

Dimensioni: 200L x 20H x 100Ø
Capacità: 150 ml

P24502

Dimensioni: 230L x 24H x 120Ø
Capacità: 250 ml



Mini pentolino con manico
Materiale: Acciaio

P24901

Dimensioni: 152L x 32H x 80Ø
Capacità: 150 ml

P24902

Dimensioni: 200L x 40H x 100Ø
Capacità: 300 ml



Mini pentolino alto con manico
Materiale: Acciaio

P24801

Dimensioni: 152L x 48H x 80Ø
Capacità: 200 ml

P24802

Dimensioni: 200L x 60H x 100Ø
Capacità: 450 ml



Mini pentola con coperchio
Materiale: Acciaio

P24600

Dimensioni: 32H x 80Ø

P24601

Dimensioni: 40H x 100Ø

P24602

Dimensioni: 48H x 120Ø



Mini pentola alta con coperchio
Materiale: Acciaio

P24701

Dimensioni: 48H x 80Ø

P24702

Dimensioni: 60H x 100Ø

P24703

Dimensioni: 72H x 120Ø



Mini sarten tonda con manici
Materiale: Acciaio smaltato

P997014

Dimensioni: 140Ø
Capacità: 400 ml

P997016

Dimensioni: 160Ø
Capacità: 500 ml



Mini Paellera Valenciana
Materiale: Acciaio smaltato

P995010

Dimensioni: 100Ø

P995016

Dimensioni: 150Ø





Vassoio ardesia da presentazione rettangolare

Materiale: Ardesia

P28403

Dimensioni: 400L x 300P



Vassoio ardesia da presentazione rettangolare

Materiale: Ardesia

P28302

Dimensioni: 300L x 200P



Vassoio ardesia da presentazione quadrato

Materiale: Ardesia

P28303

Dimensioni: 300L x 300P



Vassoio ardesia da presentazione quadrato

Materiale: Ardesia

P28252

Dimensioni: 250L x 250P



Vassoio ardesia da presentazione quadrato

Materiale: Ardesia

P28202

Dimensioni: 200L x 200P



Coppetta in foglia di palma
Materiale: Foglia di palma

CUP-120MM
Dimensioni: 120Ø
CUP-100MM
Dimensioni: 100Ø



Bowl in foglia di palma
Materiale: Foglia di palma

BOWL-180MM
Dimensioni: 180Ø
BOWL-150MM
Dimensioni: 150Ø



Piatto rotondo in foglia di palma
Materiale: Foglia di palma

RPLATE-250MM
Dimensioni: 250Ø



Piatto rettangolare in foglia di palma
Materiale: Foglia di palma

RECPLATE177X127
Dimensioni: 177L x 127P
RECPLATE240X160
Dimensioni: 240L x 160P



Piatto ovale in foglia di palma
Materiale: Foglia di palma

EGG26X16
Dimensioni: 260L x 160P



Piatto rettangolare in foglia di palma
Materiale: Foglia di palma

RETT280X180
Dimensioni: 280L x 180P



Piatto quadrato in foglia di palma
Materiale: Foglia di palma

Plate240
Dimensioni: 240L x 240P
Plate180
Dimensioni: 180L x 180P
Plate165
Dimensioni: 165L x 165P







Teglia in legno con carta da forno

Materiale: Legno

1402

Dimensioni: 30H x 50Ø

1442

Dimensioni: 30H x 75Ø

1437

Dimensioni: 40H x 100Ø

1438

Dimensioni: 40H x 120Ø

1440

Dimensioni: 40H x 140Ø

1406

Dimensioni: 40H x 180Ø



Vassoio con bordi

Materiale: Legno

1482

Dimensioni: 350L x 300P x 10H

1481

Dimensioni: 325L x 265P x 10H

1480

Dimensioni: 265L x 175P x 10H



Coperchio vassoio

Materiale: Kraft

1482-T

Dimensioni: 350L x 300P x 58H

Compatibile con: 1482

1481-T

Dimensioni: 325L x 265P x 58H

Compatibile con: 1482

1480-T

Dimensioni: 265L x 175P x 58H

Compatibile con: 1482



Vassoio con bordi

Materiale: Legno







1401

Dimensioni: 70H x 100Ø

1419

Dimensioni: 70H x 200Ø



<p>Pinza in bamboo Materiale: Bamboo</p> <p>P100570 Dimensioni: 200L</p> <p>P100571 Dimensioni: 255L</p> <p>P100572 Dimensioni: 300L</p> 	<p>Coperchio per cesta vaporiera Materiale: Bamboo</p> <p>P100550 Dimensioni: 30H x 100Ø Compatibile con: P100540</p> <p>P100551 Dimensioni: 35H x 130Ø Compatibile con: P100540</p> 	<p>Cesta vaporiera rotonda in bamboo Materiale: Bamboo</p> <p>P100540 Dimensioni: 40H x 100Ø Compatibile con: P100550</p> <p>P100541 Dimensioni: 50H x 130Ø Compatibile con: P100550</p> 
<p>Barca per presentazione sushi Materiale: Legno</p> <p>P100600 Dimensioni: 500L x 200P x 310H</p> <p>P100601 Dimensioni: 700L x 255P x 450H</p> 	<p>Tavola liscia curvata bamboo Materiale: Bamboo</p> <p>P100520 Dimensioni: 210L x 120P x 25H</p> <p>P100521 Dimensioni: 240L x 150P x 30H</p> <p>P100522 Dimensioni: 270L x 180P x 30H</p> 	<p>Tavola piana bamboo Materiale: Bamboo</p> <p>P100510 Dimensioni: 210L x 120P x 30H</p> <p>P100511 Dimensioni: 240L x 150P x 30H</p> <p>P100512 Dimensioni: 270L x 180P x 30H</p> 



Legno

DIRETTAMENTE DAL FORNO ALLA TAVOLA





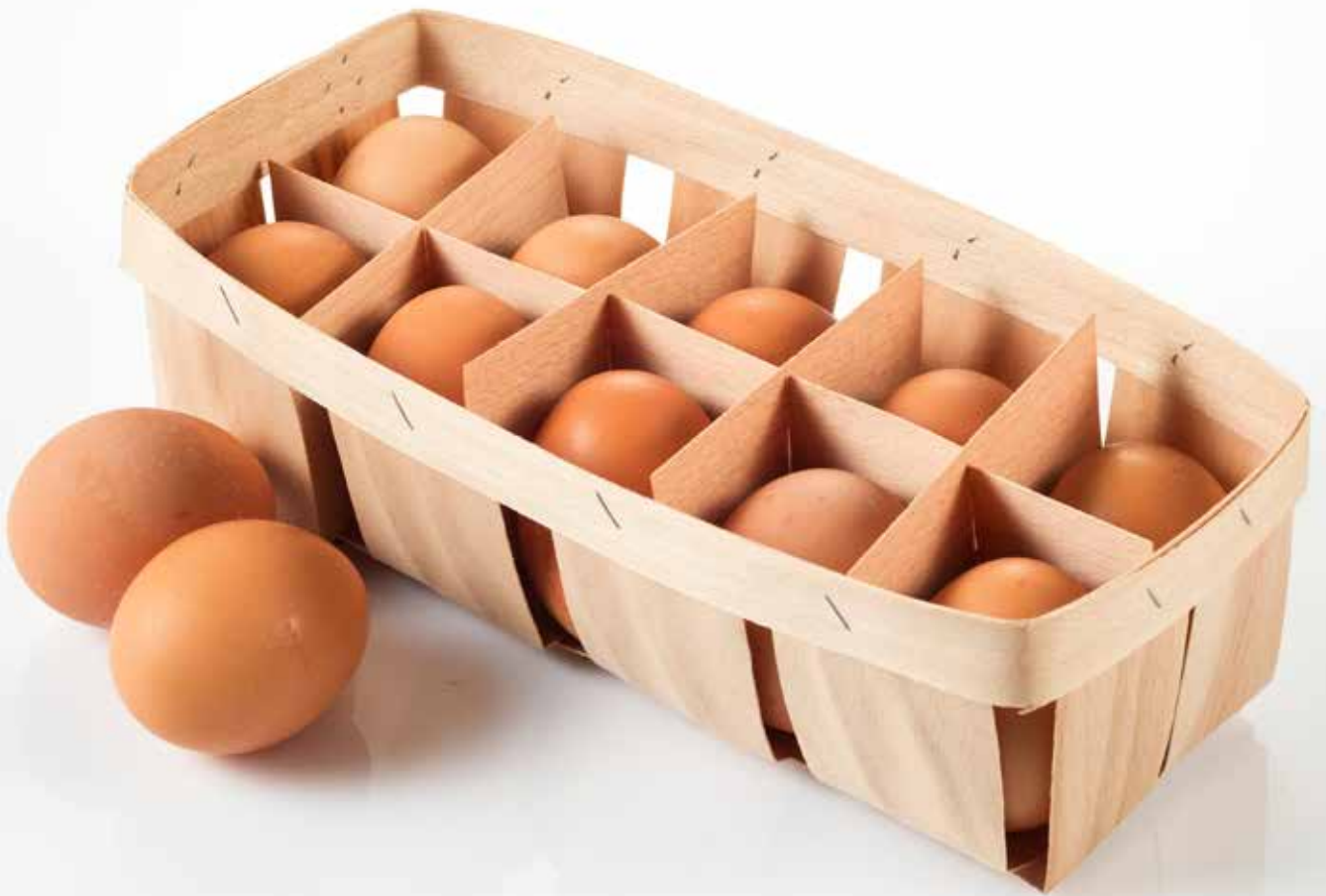



Cesta rotonda picnic con coperchio

Materiale: Legno

1550

Dimensioni: 40H x 75Ø

1551

Dimensioni: 40H x 90Ø

1552

Dimensioni: 60H x 120Ø

1553

Dimensioni: 75H x 180Ø



Cesta rotonda picnic con coperchio trasparente

Materiale: Legno

1500

Dimensioni: 135H x 145Ø



Cesta portauova

Materiale: Legno

1504

Dimensioni: 225L x 90P x 75H



Cesta picnic

Materiale: Legno

1506

Dimensioni: 250L x 70P x 50H

1510

Dimensioni: 195L x 150P x 80H



Cesta picnic

Materiale: Legno

1509

Dimensioni: 110L x 110P x 30H



Cesta picnic

Materiale: Legno

1503

Dimensioni: 165L x 165P x 66H



Cesta picnic con manico

Materiale: Legno

1514

Dimensioni: 250L x 70P x 50H





YEGAM S.R.L.

European Office: Via Ratti 4/6, 26015 Soresina (CR) - Italy

Ph. +39 0374 948 000

Fax +39 0374 254 508

yegam@yegam.it

www.yegam.it

Sede legale: P.zza De Gasperi 45/A, 35121 Padova - Italy