



DEGRENE

P A R I S

Since 1948
70 years of Excellence



2019

FAIRE NAÎTRE
LES PLUS BELLES
ÉMOTIONS



DEGRENNE
P A R I S

Les collections DEGRENNE habillent les plus belles tables et célèbrent **le renouveau de la Gastronomie Française**. Plébiscitées par de **nombreux grands Chefs** à travers le monde, nous souhaitons contribuer à votre talent du goût avec **exigence et pragmatisme**. Nous créons pour vous de véritables outils de dégustation au service de votre passion, de votre métier. **Gastronomie, bistronomie, brasserie**, quelque soit votre cuisine, la Maison DEGRENNE vous propose des **solutions adaptées à votre univers**, à votre inspiration pour faire naître auprès de votre clientèle, les plus belles émotions.

CREATING THE MOST BEAUTIFUL EMOTIONS

The DEGRENNE collections decorate the most beautiful tables and celebrate **the revival of French Gastronomy**. We have been chosen by **numerous great Chefs** worldwide and we now wish to enhance your talent for flavour with our high level of **quality and expediency**. We have created true tools to savour food and service your passion and profession. Whatever your cuisine, whether you work in **haute cuisine, a bistro or brasserie**, the Maison DEGRENNE will provide you with **solutions that are right for your environment** and inspiration so you can generate the most beautiful emotions within your customers.

DESPERTAR LAS MÁS BELLAS EMOCIONES

Las colecciones de DEGRENNE visten las mesas más hermosas y celebran **la renovación de la gastronomía francesa**. Respaldados por **numerosos chefs de renombre** de todo el mundo, deseamos contribuir a sus creaciones culinarias con **exigencia y pragmatismo**. Creamos para usted verdaderas herramientas de degustación al servicio de su pasión y su oficio. Del segmento alto al más accesible... Con independencia de su oferta, la firma DEGRENNE le ofrece **soluciones adaptadas a su universo** e inspiración para despertar en sus clientes las más bellas emociones.





HERITAGE
HERITAGE - LEGADO

P.05



DEGRENNÉ EN CHIFFRES
IN NUMBERS - EN CIFRAS

P.09



PARTENAIRES DE
L'EXCELLENCE

PARTNERS IN EXCELLENCE
SOCIOS DE LA EXCELENCIA

P.11



DEGRENNÉ DANS
LE MONDE

WORLDWIDE - EN EL MUNDO

P.13

AU CŒUR
DES TENDANCES

AT THE HEART OF TRENDS
AL RITMO DE LAS TENDENCIAS

P.15



GASTRO
NOMIE

HAUTE CUISINE
SEGMENTO ALTO



BISTRO
NOMIE

BISTROS
SEGMENTO MEDIO



BRASS
ERIE

BRASSERIES
SEGMENTO BAJO



BAN
QUET

BANQUETS
BANQUETES

LA VAISSELLE

TABLEWARE - VAJILLA

68-69	API
46-51	BAHIA
36-39	BORÉAL
40-43	BORÉAL SATIN
28-29	COLLECTION L
30-31	COLLECTION L FRAGMENT
32-33	COLLECTION L PERLES DE ROSÉE NEW
70-71	ECLIPSE NEW
72-73	ESSENTIELLE NEW
44-45	GOURMET NEW
34-35	GRAPHIQUE
64-67	MODULO
52-57	MODULO NATURE
58-59	MONDO NEW
60-61	NEWMOON
74-77	SALAM
78-79	SALAM THÉ
62-63	SMOOS

LES COUVERTS

FLATWARE - CUBIERTOS

122-123	ABSOLU
110-111	ALOA
102-103	AQUATIC
106-107	ASTRÉE CISELÉ
104-105	ASTRÉE MIROIR
142-145	BLOIS
152-153	CONFIDENCE
118-119	COUTEAUX À STEAK
128-129	FLORENCIA
98-99	GUEST CUIVRE
94-95	GUEST MIROIR
96-97	GUEST STAR
100-101	GUEST VINTAGE
92-93	L'E STARCK® NEW
140-141	LUTÈCE
130-131	MARQUISE
148-149	MIKADO MIROIR
150-151	MIKADO VINTAGE
132-133	MILADY
108-109	MIRAGE
118-119	MIRAGE LES ESSENCES NEW
134-135	NEUILLY
124-125	NORMANDY
112-113	NORWAY
146-147	ONDE NEW
117	PETIT GOURMET
116	PIÈCES COMPLÉMENTAIRES
114-115	QUARTZ
88-89	SERENITY
90-91	SOLSTICE
126-127	SQUADRO
136-139	VERLAINE
154-155	VIEUX PARIS SATINÉ
86-87	XY BLACK MIROIR
84-85	XY MIROIR

LA PLATERIE

HOLLOWWARE - ORFEBRERÍA

168-169	ACCESSOIRES PLATERIE
166-167	NEWPORT BAR
164-165	NEWPORT CAFÉTERIE
160-161	NEWPORT CUBIQUE
158-159	NEWPORT PLATEAUX
162-163	NEWPORT SERVICE À TABLE
166-167	NEWPORT LOUNGE NEW
158-159	NORMANDY NEW

LA VERRERIE

GLASSWARE - CRISTALERÍA

192-193	ALLEGRO
188-189	ANYTIME
194-195	BILBAO
186-187	CARAFES
190-191	COSMOPOLITAIN
172-173	DANDY
186-187	DÉCANTEURS
192-193	DOLCE
180-181	DOMAINE
184-185	EMPILEO NEW
176-177	GALATÉE
190-191	LOOP
194-195	MAMBO
182-183	MONTMARTRE
174-175	MUSE
178-179	ORIGINE
188-189	VERRINES

LE BUFFET EVENTO

EVENTO BUFFET - BUFÉ EVENTO

214-215	ACCESSOIRES
198-201	CHAFING DISHES
208-209	DISTRIBUTEURS À CÉRÉALES
202-205	MODULES FROIDS
218-219	PIÈCES DÉTACHÉES
216-217	PLAN
210-211	SUPPORTS À FIL RECTANGULAIRES
212-213	SUPPORTS À FIL ROUNDS
206-207	URNES À JUS DE FRUITS

LA CUISINE

KITCHENWARE - COCINA

222-223	IDÉAL FORGÉ
224-225	L'ÉCONOME
226-227	NEWCOOK EXPERT



NOTRE PASSION : VOUS INSPIRER



Entreprise
du Patrimoine
Vivant
L'excellence
des savoir-faire
français

Avec vous, nous désirons partager une véritable **culture de l'art de vivre**. Quelque soit votre approche élégante, innovante, sobre ou luxuriante, la Maison DEGRENNE dessine pour vous les collections qui sauront conter votre cuisine : **courbes, matières, couleurs, chaque détail compte** pour souligner votre travail. Tout comme le vôtre, notre métier exige de **la rigueur et le sens du détail**. Nous avons la passion du «beau» pour vous inspirer le meilleur. Cette passion est initiée dès sa fondation, il y a 70 ans, par **Guy Degrenne**. Aujourd'hui, la Maison DEGRENNE arbore avec fierté le label **Entreprise du Patrimoine Vivant**, qui consacre l'excellence artisanale et industrielle française.

OUR PASSION: INSPIRING YOU

We wish to share a genuine **lifestyle culture** with you. Whatever your approach, whether elegant, innovative or luxurious, the Maison DEGRENNE will design collections for you, which will tell the story of your cuisine: **curves, materials, colours... every detail will enhance** your work. Just like you, our profession requires us to have **a strong work ethic and be detail-orientated**. We have a passion for the "beautiful" to inspire your best work. This passion was first generated, 70 years ago, by **Guy Degrenne**, when he created the company. Today, the Maison DEGRENNE proudly bears the "**Entreprise du Patrimoine Vivant**" (living heritage company) label, a testament of French artisanal and industrial excellence.

NUESTRA PASIÓN: INSPIRARLE

Deseamos compartir con usted una auténtica **cultura del disfrute de la vida**. Con independencia de que su oferta sea elegante, innovadora, sobria o lujosa, la firma DEGRENNE diseña colecciones a imagen y semejanza de su cocina: **curvas, materiales, colores... cada detalle cuenta** para realzar sus creaciones. Nuestra profesión, como la suya, **exige rigor y atención al detalle**. Nos apasiona lo bello para inspirarle mejor. Esta pasión se inició desde la fundación de la firma, hace setenta años, por **Guy Degrenne**. En la actualidad, la firma DEGRENNE exhibe con orgullo su certificación de **Entreprise du Patrimoine Vivant** (empresa del patrimonio vivo), que reconoce la excelencia artesanal e industrial francesa.



FIER DE NOS ARTISANS!

À Vire comme à Limoges, c'est l'excellence d'hommes et de femmes passionnés par leur métier, qui perpétuent **des savoir-faire transmis de génération en génération** et sont toujours prêts à **relever de nouveaux défis**. Chaque artisan contribue à notre histoire, chaque parcours témoigne de **la richesse de nos compétences**. Le souci de **la qualité, la rigueur technique et l'art du geste bien accompli** sont les critères d'exigences communs à tous.

PROUD OF OUR ARTISANS!

Both in Vire and Limoges, men and women who are passionate about their profession perpetuate the **savoir-faire that has been transmitted from generation to generation** and are always ready to **take on new challenges**. Each artisan contributes to our story and every pathway bears witness to **the wealth of our abilities**. We require each artisan to be devoted to **high quality, rigorous technique and the art of doing things comme il faut**.

¡ORGULLOSOS DE NUESTROS ARTESANOS!

Tanto en Vire como en Limoges, unos trabajadores apasionados por su oficio perpetúan **las tradiciones transmitidas de generación en generación**, siempre dispuestos a **superar nuevos desafíos**. Cada artesano contribuye a nuestra historia; cada recorrido da fe de la **riqueza de nuestras competencias**. La atención a la **calidad, el rigor técnico y el saber hacer** son nuestros criterios y exigencias comunes.





7,5

MILLIONS DE PIÈCES PRODUITES CHAQUE ANNÉE

MILLION PIECES PRODUCED EACH YEAR

MILLONES DE PIEZAS PRODUCIDAS CADA AÑO

1300

RÉFÉRENCES CHR

HORECA REFERENCES
REFERENCIAS CHR

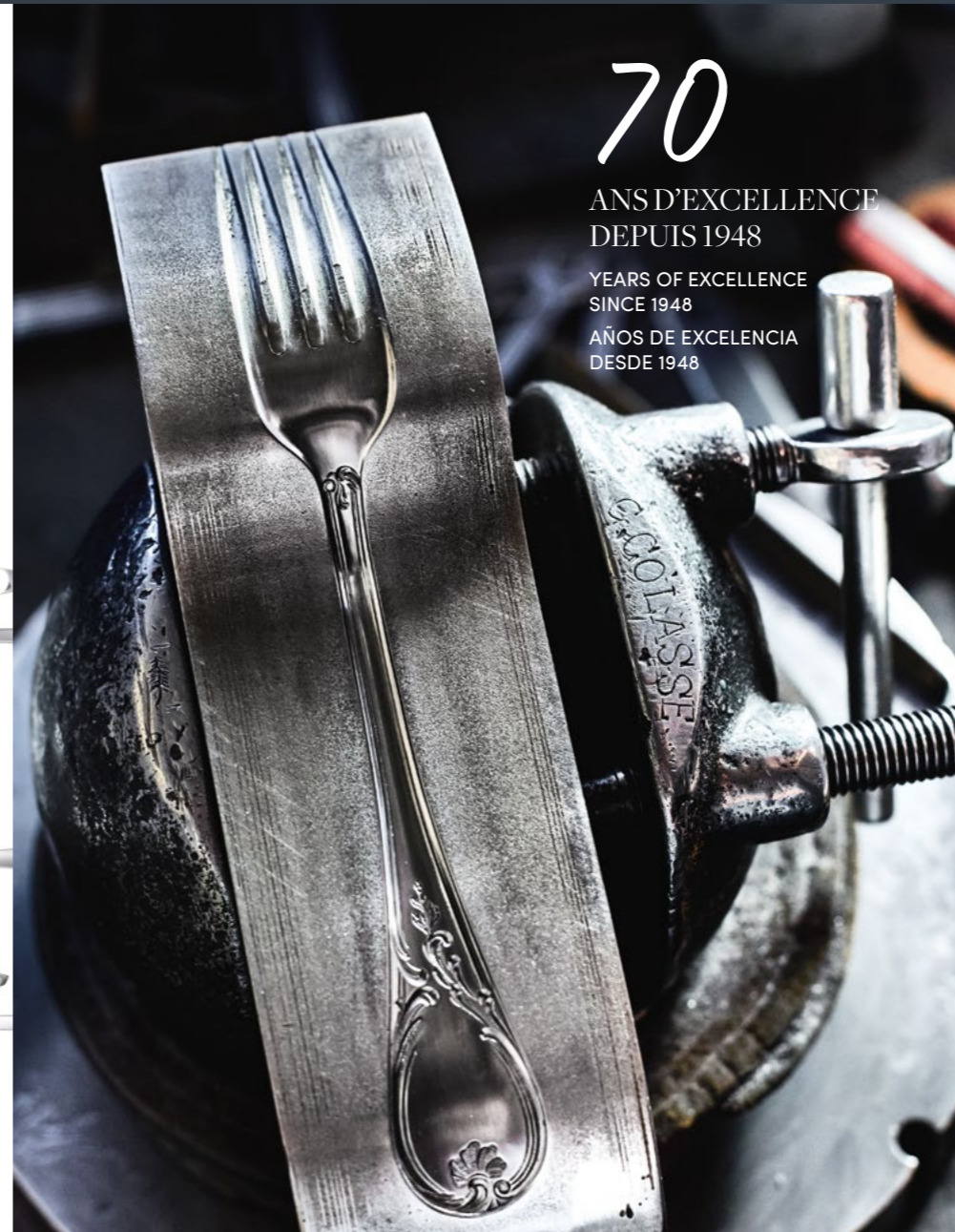

70

ANS D'EXCELLENCE DEPUIS 1948

YEARS OF EXCELLENCE SINCE 1948
AÑOS DE EXCELENCIA DESDE 1948

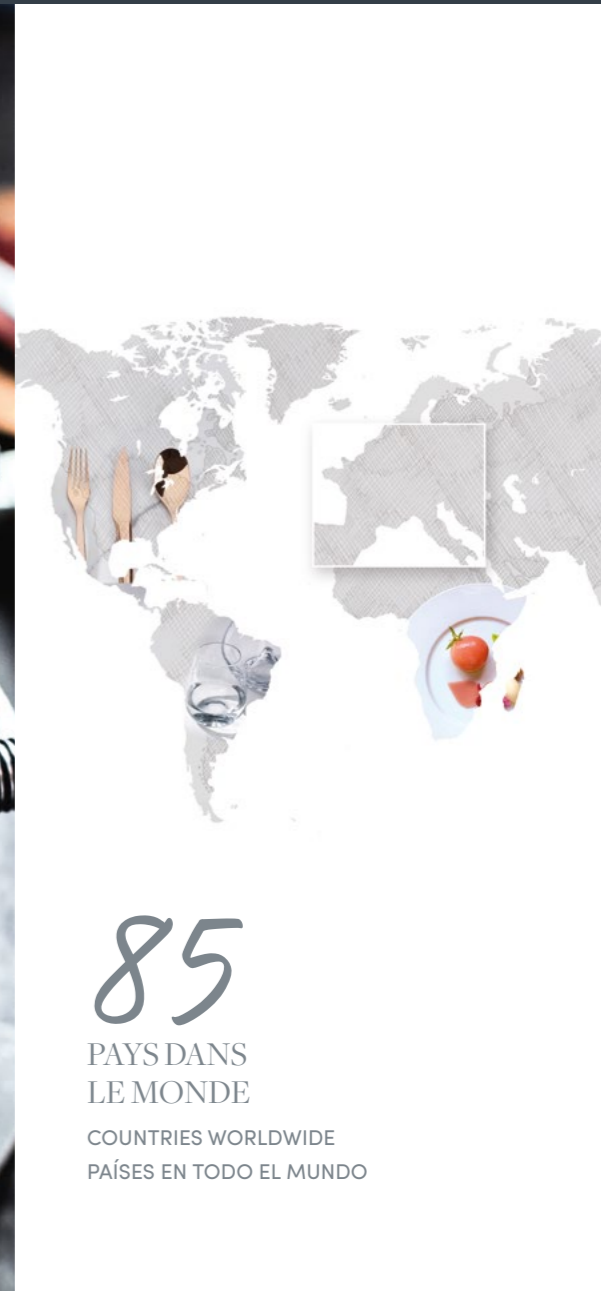

85

PAYS DANS LE MONDE

COUNTRIES WORLDWIDE
PAÍSES EN TODO EL MUNDO



750

COLLABORATEURS

PARTNERS
EMPLEADOS



3

USINES

FACTORIES
FÁBRICAS



ILS NOUS FONT CONFIANCE

THEY TRUST US

NOS DEPOSITAN SU CONFIANZA

LE FOUQUETS
SOCIÉTÉ DES BAINS DE MER
LUTETIA
WALDORF ASTORIA
PENINSULA
PLAZA
ELEVEN MADISON PARK
BELLAGIO
MARRIOTT / STARWOOD / SHERATON
FOUR SEASONS
HILTON WORLDWIDE
ACCOR HOTELS
PULLMAN
SOÏTEL / BARRIÈRE
M GALLERY / MAMA SHELTER
NOVOTEL
MERCURE
IBIS
INTERCONTINENTAL
RITZ CARLTON
LOUVRE HOTELS
GOLDEN TULIP
CAMPANILE
KYRIAD
FAIRMONT / RAFFLES HOTELS
SWISSOTEL
W HOTELS



PARTENAIRES DE L'EXCELLENCE

PARTNERS IN EXCELLENCE

SOCIOS DE LA EXCELENCIA

LES CUISINIERS DE LA RÉPUBLIQUE
LES MAÎTRES CUISINIERS DE FRANCE
ACADÉMIE CULINAIRE DE FRANCE
CLUB DES DIRECTEURS DE LA RESTAURATION
ET DE L'EXPLOITATION
LES TOQUES BLANCHES LYONNAISES
COUPE GEORGES BAPTISTE
FERRANDI
L'ÉCOLE FRANÇAISE DE GASTRONOMIE
INSTITUT PAUL BOCUSE
ÉCOLE DE MANAGEMENT L'HOTELLERIE
RESTAURATION
GLION - SUISSE
INSTITUTE OF HIGHER EDUCATION
BEST
ÉCOLE DE BORDEAUX
AFLYHT
ASSOCIATION FRANÇAISE DES LYCÉES
D'HOTELLERIE ET DE TOURISME
LES TOQUES NORMANDES
ARYZTA FOOD SOLUTIONS
EURO TOQUES - SUISSE



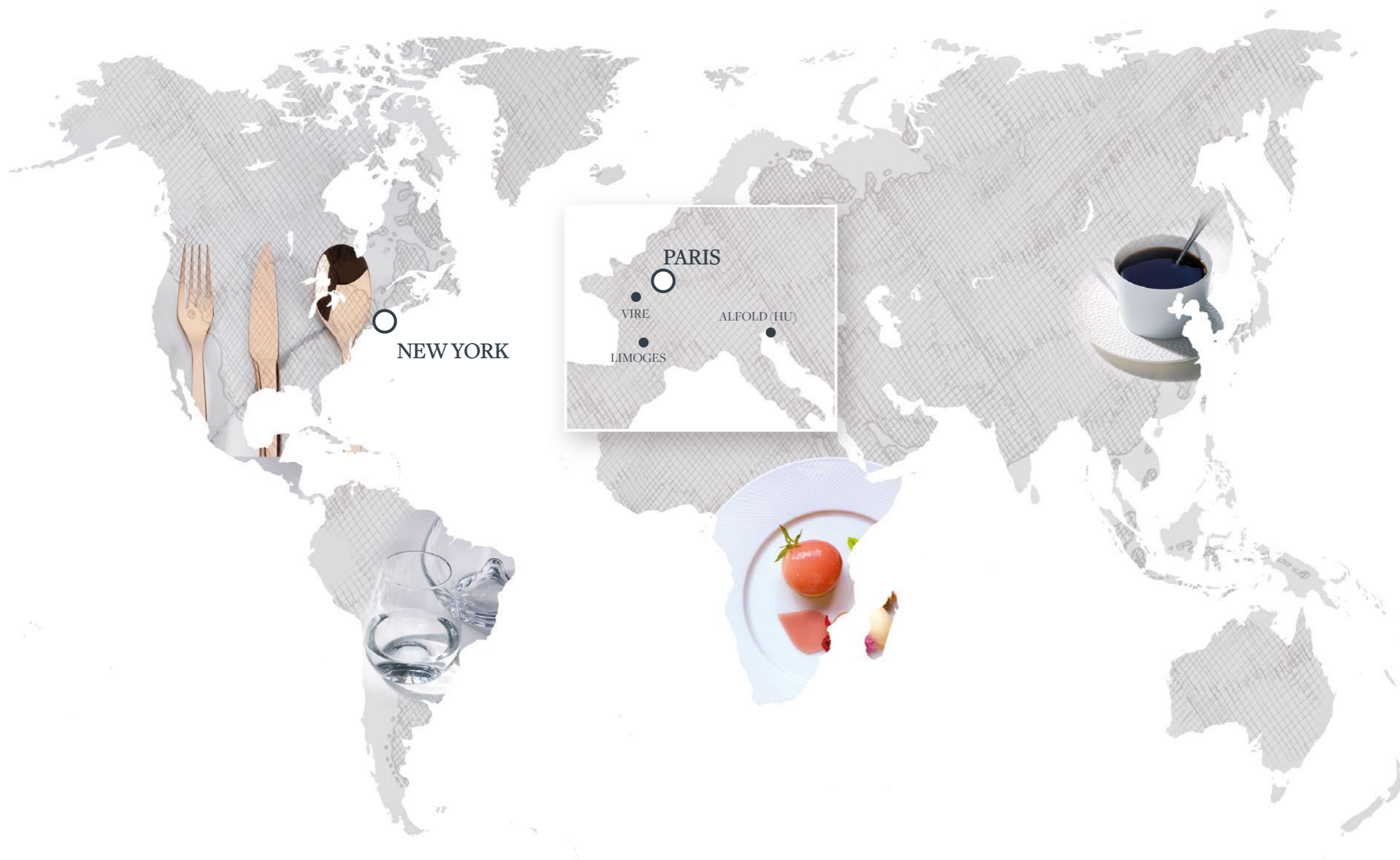

2

SHOWROOMS



PARIS

NEW YORK
41 MADISON

3

SITES DE PRODUCTION

PRODUCTION SITES
PLANTAS DE PRODUCCIÓN

VIRE / FRANCE

COUVERTS ET PLATERIE
FLATWARE AND HOLLOWWARE
CUBIERTOS E ORFEBRERÍA

LIMOGES / FRANCE

VAISSELLE
TABLEWARE
VAJILLA

ALFOLD / HONGRIE

VAISSELLE
TABLEWARE
VAJILLA





GASTRO NOMIE

HAUTE CUISINE
SEGMENTO ALTO



BISTRO NOMIE

BISTROS
SEGMENTO MEDIO



BRASS ERIE

BRASSERIES
SEGMENTO BAJO



BAN QUET

BANQUETS
BANQUETES

AU CŒUR DES TENDANCES

Voici **4 tendances** pour cette saison 2018-19 pour donner libre cours à vos idées. La Maison DEGRENNE anime ces courants gastronomiques **classiques ou novateurs** avec une **large gamme de produits à associer, mixer** entre eux pour obtenir des contrastes parfois simples, parfois étonnants, habillés de matières ou simplement lumineux.

AT THE HEART OF TRENDS

Here are **4 trends** for the 2018-19 season so you can give your ideas free rein. The Maison DEGRENNE facilitates these **classic or innovative** gastronomical trends through **a large range of products that can be mixed and matched** to obtain contrasts, which can be either simple or astonishing and are either adorned with materials or shine alone.

AL RITMO DE LAS TENDENCIAS

Presentamos **cuatro tendencias** de esta temporada 2018-19 para dar rienda suelta a su imaginación. La firma DEGRENNE complementa los estilos gastronómicos **clásicos o innovadores** con **una amplia gama** de productos **que pueden combinarse y mezclarse** para crear contrastes en ocasiones sencillos y, en otras, sorprendentes, con distintas texturas o simplemente luminosos.



L'ART DES METS

THE ART OF DISHES
EL ARTE DE LA GASTRONOMÍA

La brillante de nos porcelaines, le raffinement de nos textures sont une invitation à l'élégance : l'art du bon exige l'art du beau.

Our brilliant porcelain and refined textures invite elegance to the table: the art of the good is nothing without the art of the beautiful.

El brillo de nuestras porcelanas y el refinamiento de nuestras texturas invitan a la elegancia: para el arte de lo bueno, es imprescindible el arte de lo bello.



A



B

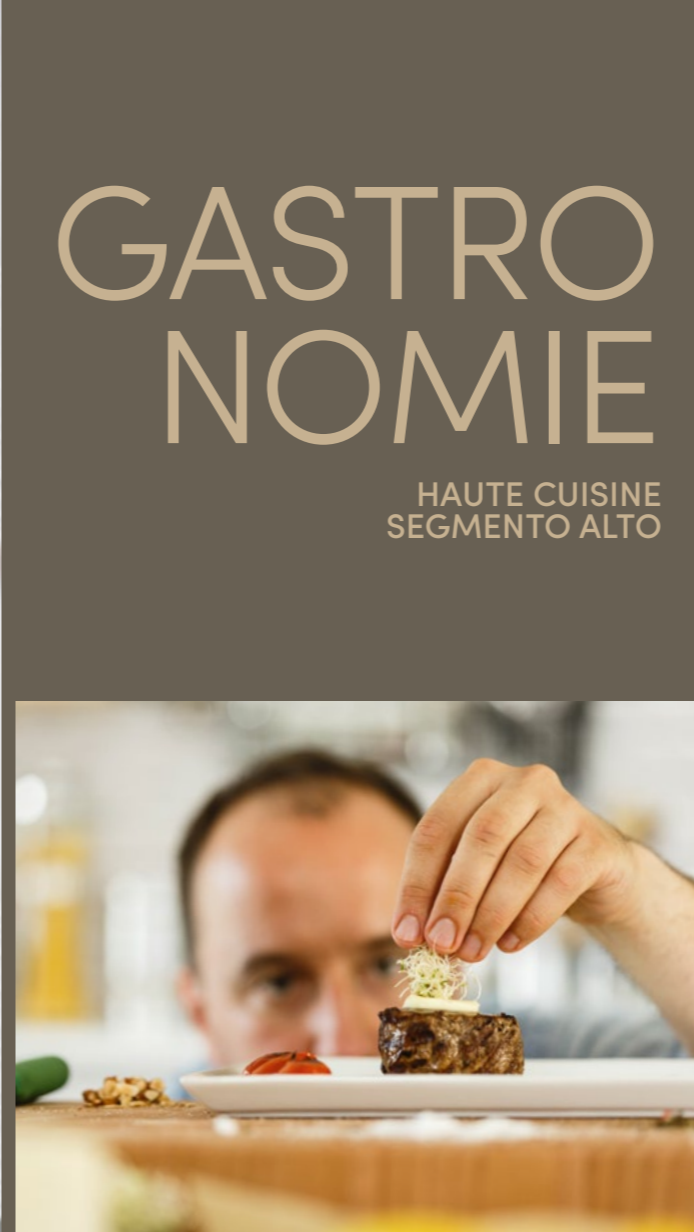

GASTRO NOMIE

HAUTE CUISINE
SEGMENTO ALTO



D

HIGH QUALITY **FRENCH-STYLE CHIC**

Raffiné **EXIGENCIA**

REFINED *Chic à la française*

REFINADO

Exigence **SOFISTICACIÓN FRANCESA**



C



- A **BORÉAL SATIN**
193324 - ASSIETTE GOURMET P.40
SHALLOW BOWL - PLATO GOURMET
- B, D **L FRAGMENT**
227844 - ASSIETTE PLATE P.30
ROUND DINNER PLATE - PLATO REDONDO
- C **BAHIA**
230944 - COCOTTE P.50
ROUND CASSEROLE - COCOTTE/BOL

TRADITION REVISITÉE

REVISITED TRADITION
LA TRADICIÓN ACTUALIZADA

Mixez nos lignes « classiques », nos matières contemporaines. Surprenez avec élégance et créativité.

Mix our "classic" lines and contemporary materials. Create surprising effects with elegance and creativity.

Combine nuestras líneas clásicas y nuestros materiales contemporáneos. Sorprenda con elegancia y creatividad.



BISTRO NOMIE

BISTROS
SEGMENTO MEDIO

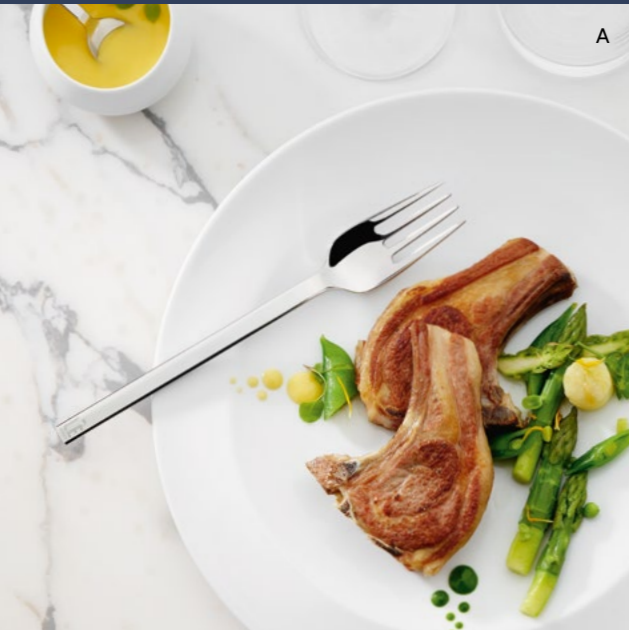

A



C



B



E

CREATIVITY

Cosmopolite

COSMOPOLITAN

CREATIVIDAD

Revisitée

ACTUALIZADO

Créativité

REVISITED

COSMOPOLITA

- A L'E STARCK**
233011 - FOURCHETTE DE TABLE
TABLE FORK - TENEDOR DE MESA P.92
- B BAHIA**
230970, 230942, 230956 - MINI BOL
SMALL BOWL - MINI BOL P.50
- C BORÉAL**
207134 - ASSIETTE PLATE OVALE
OVAL DINNER PLATE - PLATO OVAL P.36
- 207136 - ASSIETTE CALOTTE
SHALLOW BOWL - COUPE PLAT HONDO P.36
- D BAHIA**
230965 - ASSIETTE PLATE - ROUND DINNER
PLATE - PLATO REDONDO P.48
- E MODULO NATURE**
194454 - ASSIETTE PLATE - DINNER
PLATE/COUPE - PLATO REDONDO P.52

PATRIMOINE CULINAIRE

CULINARY HERITAGE
PATRIMONIO CULINARIO

Générosité et authenticité constituent l'esprit de la Brasserie. L'épure et la praticité de nos produits mettent en valeur avec simplicité un plat du jour, un tartare, un expresso...

Generosity and authenticity are at the heart of the Brasserie. The lines and practicality of our products highlight the special of the day, a tartare or an espresso in the simplest manner...

La generosidad y la autenticidad constituyen el espíritu del segmento más accesible. La sobriedad y la practicidad de nuestros productos ponen de relieve con sencillez el plato del día, un tartar o un expreso...



BRASSERIE

BRASSERIES
SEGMENTO BAJO



- A SMOOS**
207766 - TASSE À EXPRESSO - EXPRESSO CUP - EXPRESSO TAZA P.62
161025 - SOUCOUBE - ESPRESSO SAUCER - ESPRESSO PLATO P.62
- B ECLIPSE**
234609 - ASSIETTE CREUSE CALOTTE - ROUND CEREAL PLATE - PLATO HONDO P.70
- C ECLIPSE**
234604 - BOL À SALADE - SALAD BOWL - BOL DE ENSALADA P.70

A

URBANO

Citadin

URBAN

AUTHENTIC

GENEROSIDAD

Générosité

AUTÉNTICO

GENEROSITY

Authentique



B



C

L'ART DE LA RÉCEPTION

THE ART OF THE RECEPTION
EL ARTE DE LAS RECEPCIONES

Notre gamme de buffet EVENTO nos assiettes, nos verres et nos couverts s'offrent à la lumière de la journée ou d'une soirée pour célébrer votre art du moment.

Our EVENTO buffet range, our plates, our glasses and our cutlery allow you to celebrate your art of the moment by day or by night.

Nuestra gama de bufé EVENTO, nuestros platos, nuestras copas y nuestros cubiertos se muestran a la luz de un día o una noche de celebración.



BANQUET

BANQUETS
BANQUETES



FESTIVO
FESTIVE
Festif
EVENT
ELEGANTE
Evénement
EVENTO
ELEGANT



- A ANYTIME**
184567 - FLUTE À CHAMPAGNE - CHAMPAGNE FLUTE P.188
FLAUTA CHAMPÁN
- NEWPORT**
184180 - SEAU À CHAMPAGNE 2 BOUTEILLES - CHAMPAGNE BUCKET P.166
CHAMPAGNE BUCKET 2 BOTTLES - CHAMPANERA
- B NEWPORT CUBIQUE**
211886 - PLATEAU RECTANGULAIRE - RECTANGULAR SERVING P.160
TRAY - BANDEJA RECTANGULAR
- C EVENTO**
216143 - CHAFING DISH MIROIR - CHAFING DISH MIRROR FINISH P.200
MODULO DE ACERO ACABADO BRILLO
235361 - MODULE FROID BROSSÉ - REFRIGERATED SET STAINLESS P.202
STEEL BRUSHED - MODULO DE ACERO ACABADO SATINADO
- D EVENTO**
231303 - URNE À JUS DE FRUITS BROSSÉE - BRUSHED JUICE P.206
DISPENSER - DISPENSADOR DE ZUMO ACABADO SATINADO



VAISSELLE

DEGRENNE travaille les formes et les matières en portant une attention particulière aux **attentes des chefs**, tant esthétiques que dans l'usage. Pour faire de la table un moment dédié aux **plaisirs gastronomiques**, du plus simple au plus élaboré, DEGRENNE imagine **des collections uniques qui incarnent l'excellence et qui peuvent être associées entre elles**. En jouant sur les combinaisons, les contrastes, les formes, les couleurs et les matières, chaque mets trouve harmonieusement sa place à table, avec **élégance et sobriété**. **Matières nobles, lignes épurées**, épousez tous les savoir-faire DEGRENNE lorsque vous dressez votre table.

TABLEWARE

DEGRENNE develops shapes and materials, while paying careful attention to **chefs' practical usage** and aesthetic requirements. DEGRENNE designs **unique collections that are the very embodiment of excellence and can also be combined**, in order to make dining a moment of **culinary pleasure**, from the simplest to the most elaborate pleasures. Each dish harmoniously finds its rightful place on the table, with **simplicity and elegance**, thanks to the combinations, contrasts, shapes, colours and materials employed by DEGRENNE. Capitalize on DEGRENNE's extensive expertise when setting your table : we offer **sleek lines and the finest materials**.

VAJILLA

DEGRENNE trabaja las formas y los materiales prestando una atención particular a las **expectativas de los chefs**, tanto estéticas como de uso. Para convertir la mesa en un momento dedicado a los **placeres gastronómicos**, del más sencillo al más elaborado, DEGRENNE imagina **coleccionas únicas que encarnan la excelencia y que pueden combinarse entre sí**. Jugando con las combinaciones, los contrastes, las formas, los colores y los materiales, cada plato encuentra su lugar en la mesa con armonía, **elegancia y sobriedad**. **Materiales nobles, líneas depuradas**, elija todos los saber hacer de DEGRENNE a la hora de preparar su mesa.

L FRAGMENT
227847 - ASSIETTE GOURMET
DESSERT/SALAD/APP.PLATE W/WIDE RIM - PLATO REDONDO

P.30

BAHIA
230910 - COCOTTE - ROUND CASSEROLE
COCOTTE BOL

P.50





MADE IN FRANCE

PORCELAINE DE LIMOGES ET EXCELLENCE

Allez élégance et sobriété grâce à des matières nobles et des formes aux lignes épurées. D'une blancheur et d'une opalescence remarquables, la Porcelaine de Limoges est symbole d'excellence et de pureté.

LIMOGES PORCELAIN AND EXCELLENCE

Combine elegance and simplicity by harnessing the finest materials and sleek lines. **Stunning white and milky iridescent Limoges porcelain is the epitome of excellence and purity.**

PORCELANA DE LIMOGES Y EXCELENCIA

Conjuga elegancia y sobriedad gracias a materiales nobles y formas con líneas depuradas. **De una blancura y una opalescencia destacables, la porcelana de Limoges es símbolo de excelencia y de pureza.**



L
227822
ASSIETTE DE PRÉSENTATION
ROUND PRESENTATION PLATE
W/WIDE RIM
PLATO REDONDO
32 CM - 12 IN^{5/8}



L
227823
ASSIETTE PLATE
ROUND DINNER PLATE
W/WIDE RIM
PLATO REDONDO
28 CM - 11 IN



L
227824
ASSIETTE DESSERT
ROUND DESSERT/SALAD/APP.PLATE
W/WIDE RIM
PLATO REDONDO
24 CM - 9 IN^{7/16}



L
227825
ASSIETTE À PAIN
ROUND BREAD & BUTTER PLATE
W/WIDE RIM
PLATO REDONDO
14 CM - 5 IN^{1/2}



206504
**BOUCHON PORCELAINE
POUR CLOCHE VERRE**
PORCELAIN LID FOR GLASS DOME COVER
TAPA DE PORCELANA PARA
CAMPANA DE VIDRIO
5,2 CM - 2 IN^{1/16}

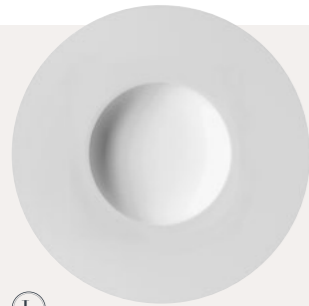

L
227826
ASSIETTE GOURMET
ROUND SHALLOW BOWL W/WIDE RIM
PLATO GOURMET
30 CM - 11 IN^{3/16}

209384



209383
BLANC BRILLANT
BRIGHT WHITE
BLANCO BRILLANTE

209384



209720
BLANC SABLÉ
SANDY WHITE
BLANCO PURO

230820



230821
BLEU
BLUE
AZUL

204042



204041
CARBONE
GREY
GRIS

AUTRES COULEURS
OTHER COLORS
OTROS COLORES



BAHIA P.50



204043
CLOCHE VERRE BOROSILICATE
GLASS DOME COVER
CAMPANA VIDRIO BOROSILICATO
17X9 CM - 6 IN^{11/16} X 3 IN^{9/16}

COMPATIBLE AVEC LES COCOTTES GOURMET & BAHIA
COMPATIBLE WITH GOURMET & BAHIA ROUND CASSEROLES
COMPATIBLE CON GOURMET & BAHIA COCOTTE BOLES



L
227827
ASSIETTE GOURMET
ROUND SHALLOW BOWL W/WIDE RIM
PLATO GOURMET
28 CM - 11 IN



186849
BLANC BRILLANT
BRIGHT WHITE
BLANCO BRILLANTE



211893
BLANC SABLÉ
SANDY WHITE
BLANCO PURO



230822
BLEU
BLUE
AZUL



234209
CARBONE
CARBONE/BLACK
NEGRO

AUTRES COULEURS
OTHER COLORS
OTROS COLORES



BAHIA P.50



182614
CLOCHE INOX
DOME COVER, STAINLESS STEEL
CAMPANA
24 CM - Ø 9 IN^{7/16}

COMPATIBLE AVEC LES BOLS GOURMET & BAHIA
COMPATIBLE WITH GOURMET & BAHIA BOWLS
COMPATIBLE CON BOLES GOURMET & BAHIA



L
227828
TASSE ESPRESSO
DEMITASSE CUP
ESPRESSO TAZA
10 CL - 3 OZ^{2/8}



L
227831
SOUCOUPE ESPRESSO
DEMITASSE SAUCER
ESPRESSO PLATO
12,5 CM - 4 IN^{5/16}



L
227829
TASSE LUNGO
COFFEE/TEA CUP
LUNGO TAZA
25 CL - 8 OZ^{7/16}



L
227832
SOUCOUPE LUNGO
COFFEE/TEA SAUCER
LUNGO PLATO
15,8 CM - 6 IN^{1/4}



CÉRAMIQUE TEINTÉE MASSE
MASS COLORED CERAMIC
CERÁMICA COLORADO A TODA MESA



182301
CLOCHE INOX
DOME COVER, STAINLESS STEEL
CAMPANA
14,8 CM - Ø 5 IN^{13/16}



COLLECTION L FRAGMENT

MADE IN FRANCE



L

227843
ASSIETTE DE PRÉSENTATION
ROUND PRESENTATION PLATE
W/WIDE RIM
PLATO REDONDO
32 CM - 12 IN^{5/8}



L

227844
ASSIETTE PLATE
ROUND DINNER PLATE
W/WIDE RIM
PLATO REDONDO
28 CM - 11 IN

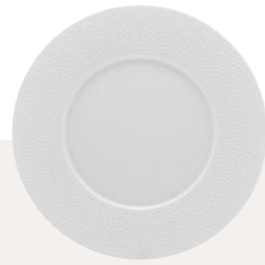

L

227845
ASSIETTE DESSERT
ROUND DESSERT/SALAD/APP.PLATE
W/WIDE RIM
PLATO REDONDO
24 CM - 9 IN^{7/16}



L

227846
ASSIETTE À PAIN
ROUND BREAD & BUTTER PLATE/WIDE
RIM
PLATO REDONDO
14 CM - 5 IN^{1/2}

206504
**BOUCHON PORCELAINE
POUR CLOCHE VERRE**
PORCELAIN LID FOR GLASS DOME COVER
TAPA DE PORCELANA PARA
CAMPANA DE VIDRIO
5,2 CM - 2 IN^{17/16}



L

227847
ASSIETTE GOURMET
ROUND SHALLOW BOWL W/WIDE RIM
PLATO GOURMET
30 CM - 11 IN^{3/16}

209384



209383
BLANC BRILLANT
BRIGHT WHITE
BLANCO BRILLANTE

209384



209720
BLANC SABLÉ
SANDY WHITE
BLANCO PURO

230820



230821
BLEU
BLUE
AZUL

204042



204041
CARBONE
GREY
GRIS

AUTRES COULEURS
OTHER COLORS
OTROS COLORES



BAHIA P.50



204043
CLOCHE VERRE BOROSILICATE
GLASS DOME COVER
CAMPANA VIDRIO BOROSILICATO
17X9 CM - 6 IN^{11/16} X 3 IN^{9/16}



L

227848
ASSIETTE GOURMET
ROUND SHALLOW BOWL W/WIDE RIM
PLATO GOURMET
28 CM - 11 IN



186849
BLANC BRILLANT
BRIGHT WHITE
BLANCO BRILLANTE



211893
BLANC SABLÉ
SANDY WHITE
BLANCO PURO



230822
BLEU
BLUE
AZUL



234209
CARBONE
CARBONE/BLACK
NEGRO

AUTRES COULEURS
OTHER COLORS
OTROS COLORES



BAHIA P.50



182614
CLOCHE INOX
DOME COVER, STAINLESS STEEL
CAMPANA
24 CM - Ø 9 IN^{7/16}

COMPATIBLE AVEC LES BOLS GOURMET & BAHIA
COMPATIBLE WITH GOURMET & BAHIA BOWLS
COMPATIBLE CON BOLES GOURMET & BAHIA



L

227828
TASSE ESPRESSO
DEMITASSE CUP
ESPRESSO TAZA
10 CL - 3 OZ^{3/8}



L

227849
SOUCOUPE ESPRESSO
DEMITASSE SAUCER
ESPRESSO PLATO
12,6 CM - 4 IN^{15/16}



L

227829
TASSE LUNGO
COFFEE/TEA CUP
LUNGO TAZA
25 CL - 8 OZ^{7/16}



L

227850
SOUCOUPE LUNGO
COFFEE/TEA SAUCER
LUNGO PLATO
15,8 CM - 6 IN^{1/4}



CÉRAMIQUE TEINTÉE MASSE
MASS COLORED CERAMIC
CERÁMICA COLORADO A TODA MESA



182301
CLOCHE INOX
DOME COVER, STAINLESS STEEL
CAMPANA
14,8 CM - Ø 5 IN^{13/16}

NEW COLLECTION L
PERLES DE ROSÉE

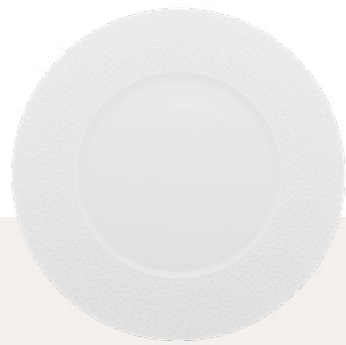

L **NEW**

233922
ASSIETTE DE PRÉSENTATION
ROUND PRESENTATION PLATE
W/WIDE RIM
PLATO REDONDO
32 CM - 12 IN^{5/8}

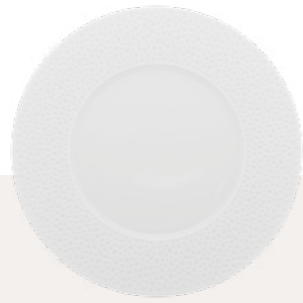

L **NEW**

233923
ASSIETTE PLATE
ROUND DINNER PLATE
W/WIDE RIM
PLATO REDONDO
28 CM - 11 IN



L **NEW**

233924
ASSIETTE DESSERT
ROUND DESSERT/SALAD/APP.PLATE
W/WIDE RIM
PLATO REDONDO
24 CM - 9 IN^{7/16}



L **NEW**

233925
ASSIETTE À PAIN
ROUND BREAD & BUTTER PLATE
W/WIDE RIM
PLATO REDONDO
14 CM - 5 IN^{1/2}



206504
**BOUCHON PORCELAINE
POUR CLOCHE VERRE**
PORCELAIN LID FOR GLASS DOME COVER
TAPA DE PORCELANA PARA
CAMPANA DE VIDRIO
5,2 CM - 2 IN^{7/16}

COMPATIBLE AVEC LES GRANDES ASSIETTES COCOTTE GOURMET P.44
COMPATIBLE WITH LARGE CASSEROLE PLATES GOURMET P.44
COMPATIBLE CON GRANDES COCOTTE PLATOS GOURMET P.44



L **NEW**

233926
ASSIETTE GOURMET
ROUND SHALLOW BOWL W/WIDE RIM
PLATO GOURMET
30 CM - 11 IN^{3/16}

209384



209383
BLANC BRILLANT
BRIGHT WHITE
BLANCO BRILLANTE

209384



209720
BLANC SABLÉ
SANDY WHITE
BLANCO PURO

230820



230821
BLEU
BLUE
AZUL

204042



204041
CARBONE
GREY
GRIS

AUTRES COULEURS
OTHER COLORS
OTROS COLORES



BAHIA P.50



204043
CLOCHE VERRE BOROSILICATE
GLASS DOME COVER
CAMPANA VIDRIO BOROSILICATO
17X9 CM - 6 IN^{11/16} X 3 IN^{9/16}

COMPATIBLE AVEC LES COCOTTES GOURMET & BAHIA
COMPATIBLE WITH GOURMET & BAHIA ROUND CASSEROLES
COMPATIBLE CON GOURMET & BAHIA COCOTTE BOLES



L **NEW**

233927
ASSIETTE GOURMET
ROUND SHALLOW BOWL W/WIDE RIM
PLATO GOURMET
28 CM - 11 IN



186849
BLANC BRILLANT
BRIGHT WHITE
BLANCO BRILLANTE



211893
BLANC SABLÉ
SANDY WHITE
BLANCO PURO



230822
BLEU
BLUE
AZUL



234209
CARBONE
CARBONE/BLACK
NEGRO

AUTRES COULEURS
OTHER COLORS
OTROS COLORES



BAHIA P.50



182614
CLOCHE INOX
DOME COVER, STAINLESS STEEL
CAMPANA
24 CM - Ø 9 IN^{7/16}

COMPATIBLE AVEC LES BOLS GOURMET & BAHIA
COMPATIBLE WITH GOURMET & BAHIA BOWLS
COMPATIBLE CON BOLES GOURMET & BAHIA



227828
TASSE ESPRESSO
DEMITASSE CUP
ESPRESSO TAZA
10 CL - 3 OZ^{2/8}



233928
SOUCOUBE ESPRESSO
DEMITASSE SAUCER
ESPRESSO PLATO
12,6 CM - 4 IN^{15/16}



227829
TASSE LUNGO
COFFEE/TEA CUP
LUNGO TAZA
25 CL - 8 OZ^{7/16}



233929
SOUCOUBE LUNGO
COFFEE/TEA SAUCER
LUNGO PLATO
15,8 CM - 5 IN^{7/16}



CÉRAMIQUE TEINTÉE MASSE
MASS COLORED CERAMIC
CERÁMICA COLORADO A TODA MESA



182301
CLOCHE INOX
DOME COVER, STAINLESS STEEL
CAMPANA
14,8 CM - Ø 5 IN^{13/16}



213936
ASSIETTE DE PRÉSENTATION
ROUND PRESENTATION PLATE
W/WIDE RIM
PLATO REDONDO
32 CM - 12 IN^{3/8}



213938
ASSIETTE PLATE
ROUND DINNER PLATE
W/WIDE RIM
PLATO REDONDO
28 CM - 11 IN



213940
ASSIETTE DESSERT
ROUND DESSERT/SALAD/APP.PLATE
W/WIDE RIM
PLATO REDONDO
24 CM - 9 IN^{7/16}

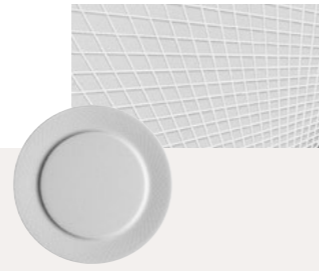

213942
ASSIETTE À PAIN
ROUND BREAD & BUTTER PLATE
W/WIDE RIM
PLATO REDONDO
14 CM - 5 IN^{1/2}



206504
**BOUCHON PORCELAINE
POUR CLOCHE VERRE**
PORCELAIN LID FOR GLASS DOME COVER
TAPA DE PORCELANA PARA
CAMPANA DE VIDRIO
5,2 CM - 2 IN^{1/8}



204043
CLOCHE VERRE BOROSILICATE
GLASS DOME COVER
CAMPANA VIDRIO BOROSILICATO
17X9 CM - 6 IN^{17/16} X 3 IN^{3/16}

COMPATIBLE AVEC LES GRANDES ASSIETTES COCOTTE GOURMET P.44
COMPATIBLE WITH LARGE CASSEROLE PLATES GOURMET P.44
COMPATIBLE CON GRANDES COCOTTE PLATOS GOURMET P.44

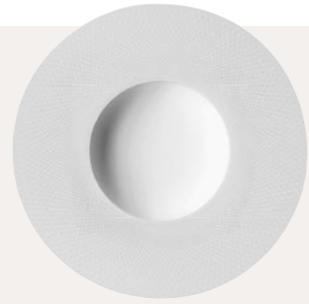

222366
ASSIETTE GOURMET
ROUND SHALLOW BOWL W/WIDE RIM
PLATO GOURMET
30 CM - 11 IN^{3/16}



209384
BLANC BRILLANT
BRIGHT WHITE
BLANCO BRILLANTE



209720
BLANC SABLÉ
SANDY WHITE
BLANCO PURO



230820
BLEU
BLUE
AZUL



204042
CARBONE
GREY
GRIS



AUTRES COULEURS
OTHER COLORS
OTROS COLORES

BAHIA P.50



182614
CLOCHE INOX
DOME COVER, STAINLESS STEEL
CAMPANA
24 CM - Ø 9 IN^{7/16}

ASSIETTE/COUVERCLE DE COCOTTE ROND
ROUND PLATE/CASSEROLE LID
BOL/PLATO RONDO PAN
12,5 CM - 4 IN^{5/16}

COCOTTE GOURMET
GOURMET ROUND CASSEROLE
COCOTTE BOL GOURMET
14 CM - 5 IN^{1/2}
50 CL - 16 OZ^{15/16}

COMPATIBLE AVEC LES COCOTTES GOURMET & BAHIA
COMPATIBLE WITH GOURMET & BAHIA ROUND CASSEROLES
COMPATIBLE CON GOURMET & BAHIA COCOTTE BOLES



222365
ASSIETTE GOURMET
ROUND SHALLOW BOWL W/WIDE RIM
PLATO GOURMET
28 CM - 11 IN



186849
BLANC BRILLANT
BRIGHT WHITE
BLANCO BRILLANTE



211893
BLANC SABLÉ
SANDY WHITE
BLANCO PURO



230822
BLEU
BLUE
AZUL



234209
CARBONE
CARBONE/BLACK
NEGRO



AUTRES COULEURS
OTHER COLORS
OTROS COLORES

BAHIA P.50



182301
CLOCHE INOX
DOME COVER, STAINLESS STEEL
CAMPANA
14,8 CM - Ø 5 IN^{13/16}

BOL GOURMET
GOURMET BOWL
BOL GOURMET
12 CM - 4 IN^{3/4}
30 CL - 10 OZ^{1/8}

COMPATIBLE AVEC LES BOLS GOURMET & BAHIA
COMPATIBLE WITH GOURMET & BAHIA BOWLS
COMPATIBLE CON BOLES GOURMET & BAHIA



207756
TASSE ESPRESSO
DEMITASSE CUP
ESPRESSO TAZA
10 CL - 3 OZ^{3/8}



223406
SOUCOUBE ESPRESSO
DEMITASSE SAUCER
ESPRESSO PLATO
12,5 CM - 4 IN^{5/16}



207757
TASSE LUNGO
COFFEE/TEA CUP
LUNGO TAZA
20 CL - 6 OZ^{3/4}



223407
SOUCOUBE LUNGO
COFFEE/TEA SAUCER
LUNGO PLATO
15 CM - 5 IN^{7/8}



CÉRAMIQUE TEINTÉE MASSE
MASS COLORED CERAMIC
CERÁMICA COLORADO A TODA MESA

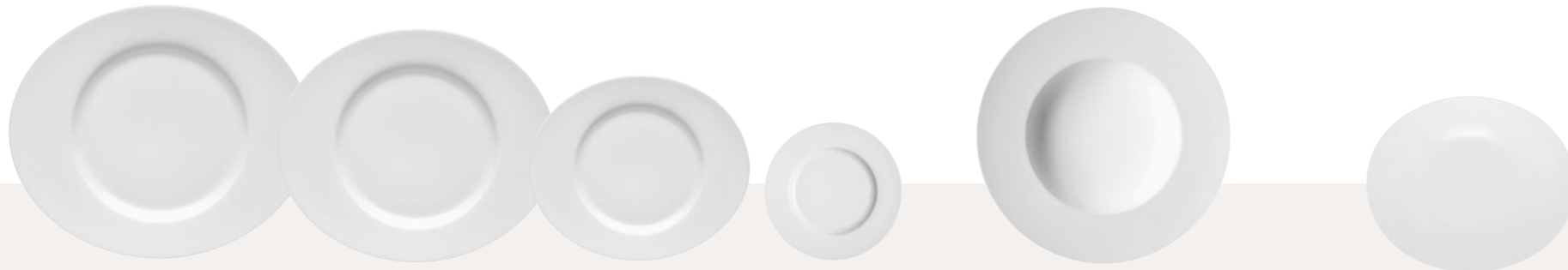

207137
ASSIETTE DE PRÉSENTATION OVALE
OVAL PRESENTATION PLATE
PLATO PRESENTACIÓN OVAL
34,5 X 29 CM - 13 IN^{3/8} X 11 IN^{7/16}

207134
ASSIETTE PLATE OVALE
OVAL DINNER PLATE
PLATO OVAL
31 X 26,5 CM - 12 IN^{3/16} X 10 IN^{7/16}

207135
ASSIETTE DESSERT OVALE
OVAL DESSERT PLATE
PLATO OVAL
24 X 20,5 CM - 9 IN^{7/16} X 8 IN^{1/16}

207139
ASSIETTE À PAIN RONDE
ROUND BREAD & BUTTER PLATE
PLATO DE PAN REDONDO
16 CM - 6 IN^{5/16}

207140
ASSIETTE À PÂTES
ROUND SOUP/PASTA BOWL W/WIDE RIM
PLATO HONDO PASTA REDONDA
29 CM - 11 IN^{7/16}

207136
ASSIETTE CALOTTE OVALE
OVAL SHALLOW BOWL, COUPE
PLATO HONDO OVAL
23,5 X 20 CM - 9 IN^{1/4} X 7 IN^{7/16}



204040
ASSIETTE GOURMET OVALE GRAND BASSIN
SHALLOW BOWL W/WIDE OVAL RIM
PLATO GOURMET OVAL FONDO GRANDE
32 X 27 CM - 12 IN^{5/8} X 10 IN^{5/8}
27 CL - 9 OZ^{1/8}



207141
ASSIETTE GOURMET OVALE BASSIN PLAT
OVAL PLATE W/WIDE - RIM, FLAT
PLATO GOURMET OVAL
30 X 26 CM - 11 IN^{13/16} X 10 IN^{1/4}
27 CL - 9 OZ^{1/8}

209384



209383
BLANC BRILLANT
BRIGHT WHITE
BLANCO BRILLANTE

209384



209720
BLANC SABLÉ
SANDY WHITE
BLANCO PURO

230820



230821
BLEU
BLUE
AZUL

204042



204041
CARBONE
GREY
GRIS

AUTRES COULEURS
OTHER COLORS
OTROS COLORES



BAHIA P.50

ASSIETTE/COUVERCLE DE COCOTTE ROND
ROUND PLATE/CASSEROLE LID
BOL/PLATO RONDO PAN
12,5 CM - 4 IN^{5/16}

COCOTTE GOURMET
GOURMET ROUND CASSEROLE
COCOTTE BOL GOURMET
14 CM - 5 IN^{1/2}
50 CL - 16 OZ^{5/16}

206504
BOUCHON PORCELAINE POUR CLOCHE VERRE
PORCELAIN LID FOR GLASS DOME COVER
TAPA DE PORCELANA PARA CAMPANA DE VIDRIO
5,2 CM - 2 IN^{1/16}



204043
CLOCHE VERRE BOROSILICATE
GLASS DOME COVER
CAMPANA VIDRIO BOROSILICATO
17X9 CM - 6 IN^{1/16} X 3 IN^{5/16}

COMPATIBLE AVEC LES COCOTTES GOURMET & BAHIA
COMPATIBLE WITH GOURMET & BAHIA ROUND CASSEROLES
COMPATIBLE CON GOURMET & BAHIA COCOTTE BOLES



207138
ASSIETTE GOURMET OVALE PETIT BASSIN
SHALLOW BOWL W/WIDE OVAL RIM
PLATO GOURMET OVAL FONDO PEQUEÑO
30 X 26 CM - 11 IN^{13/16} X 10 IN^{1/4}
17 CL - 5 OZ^{3/4}



186849
BLANC BRILLANT
BRIGHT WHITE
BLANCO BRILLANTE
BOL GOURMET
GOURMET BOWL
BOL GOURMET
12 CM - 4 IN^{3/4}
30 CL - 10 OZ^{2/8}



211893
BLANC SABLÉ
SANDY WHITE
BLANCO PURO



230822
BLEU
BLUE
AZUL



234209
CARBONE
CARBONE/BLACK
NEGRO

AUTRES COULEURS
OTHER COLORS
OTROS COLORES



BAHIA P.50

COMPATIBLE AVEC LES BOLS GOURMET & BAHIA
COMPATIBLE WITH GOURMET & BAHIA BOWLS
COMPATIBLE CON BOLES GOURMET & BAHIA



182614
CLOCHE INOX
DOME COVER, STAINLESS STEEL
CAMPANA
24 CM - Ø 9 IN^{7/16}



182301
CLOCHE INOX
DOME COVER, STAINLESS STEEL
CAMPANA
14,8 CM - Ø 5 IN^{13/16}



CÉRAMIQUE TEINTÉE MASSE
MASS COLORED CERAMIC
CERÁMICA COLORADO A TODA MESA





186782
SALADIER
SALAD BOWL DEEP
ENSALADERA
28 X 24 CM - 11 IN X 9 IN^{7/16}
H : 11 CM - 4 IN^{5/16}



186779
COUPELLE
DEEP BOWL, SMALL
BOL
14 X 12 CM - 5 IN^{1/2} X 4 IN^{3/4}
H : 5 CM - 4 IN^{5/16}



186797
VERRINE
RAMEKIN
VASO
6 CL - 2 OZ
H : 5,5 CM - 2 IN^{3/16}



186851
VERRINE
RAMEKIN
VASO
12 CL - 4 OZ^{1/16}
H : 7 CM - 2 IN^{3/4}

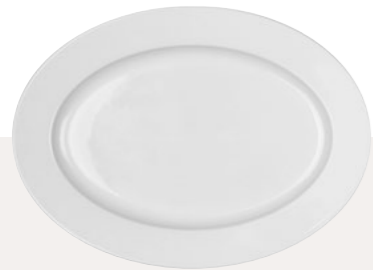

200102
PLAT OVAL CREUX
OVAL CHOP PLATE W/RIM, FLAT
PLATO HONDO OVOLADO
36,5 X 26,5 CM - 14 IN^{3/8} X 10 IN^{7/16}



186788
PLAT À CAKE
OVAL LONG DISH W/WIDE RIM, FLAT
FUENTE OVOLADO
40,5 X 19 CM - 15 IN^{5/16} X 7 IN^{1/2}

NEWPORT CAFÉTERIE - TEATIME - TÉ CAFÉ



207756
TASSE ESPRESSO
DEMITASSE CUP
ESPRESSO TAZA
10 CL - 3 OZ^{3/8}



207757
TASSE LUNGO
COFFEE/TEA CUP
LUNGO TAZA
20 CL - 6 OZ^{3/4}



207758
TASSE DÉJEUNER
BREAKFAST CUP
TAZA DESAYUNO
40 CL - 13 OZ^{1/2}

207759
SOUCOUPE ESPRESSO
DEMITASSE SAUCER
ESPRESSO PLATO
12,5 CM - 4 IN^{5/16}

207760
SOUCOUPE LUNGO
COFFEE/TEA SAUCER
LUNGO PLATO
15,8 CM - 5 IN^{7/8}

207761
SOUCOUPE DÉJEUNER
BREAKFAST SAUCER
PLATO DESAYUNO
18 CM - 7 IN^{7/8}



207763
VERSEUSE
COFFEE/TEA POT
CAFETERA/TETERA
40 CL - 13 OZ^{1/2}



207764
VERSEUSE
COFFEE/TEA POT
CAFETERA/TETERA
80 CL - 27 OZ^{1/16}



207762
CRÉMIER
CREAM JUG
LECHERA
10 CL - 3 OZ^{3/8}



COUVERCLES VERSEUSES
LIDS FOR TEA POTS
TAPAS CAFETERAS
210911 210912
6,6 CM - 2 IN^{5/8} 8,4 CM - 3 IN^{5/16}
40 CL - 13 OZ^{1/2} 80 CL - 27 OZ^{1/16}



BORÉAL SATIN

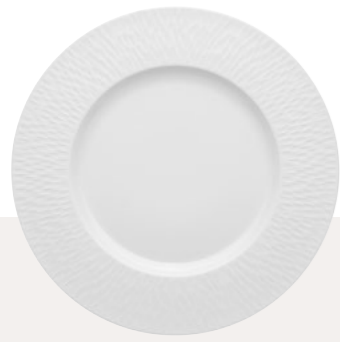

193319
ASSIETTE DE PRÉSENTATION RONDE
ROUND PRESENTATION PLATE
W/WIDE RIM
PLATO PRESENTACIÓN REDONDO
33 CM - 13 IN



193318
ASSIETTE PLATE RONDE
ROUND DINNER PLATE
W/WIDE RIM
PLATO REDONDO
28,5 CM - 11 IN^{1/4}



193320
ASSIETTE DESSERT RONDE
ROUND DESSERT/SALAD/APP.PLATE
W/WIDE RIM
PLATO REDONDO
22,5 CM - 8 IN^{7/8}



202470
ASSIETTE À PAIN RONDE
ROUND BREAD & BUTTER PLATE
PLATO DE PAN REDONDO
15 CM - 5 IN^{7/8}



223954
ASSIETTE À PÂTES/SOUBE RONDE
ROUND SOUP/PASTA BOWL
W/WIDE RIM
PLATO HONDO PASTA REDONDA
29 CM - 11 IN^{7/16}



207769
ASSIETTE GOURMET OVALE GRAND BASSIN
SHALLOW BOWL W/WIDE OVAL RIM
SATIN FINISH
PLATO GOURMET OVAL FONDO GRANDE
32 X 27 CM - 12 IN^{5/8} X 10 IN^{5/8}
27 CL - 9 OZ^{1/8}

209384



209383
BLANC BRILLANT
BRIGHT WHITE
BLANCO BRILLANTE

209384



209720
BLANC SABLÉ
SANDY WHITE
BLANCO PURO

230820



230821
BLEU
BLUE
AZUL

204042



204041
CARBONE
GREY
GRIS

AUTRES COULEURS
OTHER COLORS
OTROS COLORES



BAHIA P.50

206504

BOUCHON PORCELAINE POUR CLOCHE VERRE
PORCELAIN LID FOR GLASS DOME COVER
TAPA DE PORCELANA PARA CAMPANA DE VIDRIO
5,2 CM - 2 IN^{7/16}



204043

CLOCHE VERRE BOROSILICATE
GLASS DOME COVER
CAMPANA VIDRIO BOROSILICATO
17X9 CM - 6 IN^{11/16} X 3 IN^{9/16}

COMPATIBLE AVEC LES COCOTTES GOURMET & BAHIA
COMPATIBLE WITH GOURMET & BAHIA ROUND CASSEROLES
COMPATIBLE CON GOURMET & BAHIA COCOTTE BOLES



193324
ASSIETTE GOURMET OVALE PETIT BASSIN
SHALLOW BOWL W/WIDE OVAL RIM
SATIN FINISH
PLATO GOURMET OVAL FONDO PEQUEÑO
30 X 26 CM - 11 IN^{13/16} X 10 IN^{1/4}
17 CL - 5 OZ^{3/4}



186849
BLANC BRILLANT
BRIGHT WHITE
BLANCO BRILLANTE



211893
BLANC SABLÉ
SANDY WHITE
BLANCO PURO



230822
BLEU
BLUE
AZUL



234209
CARBONE
CARBONE/BLACK
NEGRO

AUTRES COULEURS
OTHER COLORS
OTROS COLORES



BAHIA P.50

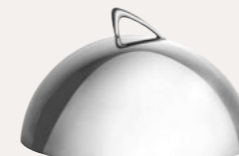

182614
CLOCHE INOX
DOME COVER, STAINLESS STEEL
CAMPANA
24 CM - Ø 9 IN^{7/16}

COMPATIBLE AVEC LES BOLS GOURMET & BAHIA
COMPATIBLE WITH GOURMET & BAHIA BOWLS
COMPATIBLE CON BOLES GOURMET & BAHIA



182301
CLOCHE INOX
DOME COVER, STAINLESS STEEL
CAMPANA
14,8 CM - Ø 5 IN^{13/16}



CÉRAMIQUE TEINTÉE MASSE
MASS COLORED CERAMIC
CERÁMICA COLORADO A TODA MESA

BORÉAL SATIN

DORÉ - GOLDED - DORADO



225193
ASSIETTE DE PRÉSENTATION
PRESENTATION PLATE W/WIDE RIM
PLATO PRESENTACIÓN
33 CM - 13 IN

225194
ASSIETTE PLATE
DINNER PLATE W/WIDE RIM
PLATO REDONDO
28,5 CM - 11 IN^{1/4}

225195
ASSIETTE DESSERT
DESSERT/SALAD/APP.PLATE
W/WIDE RIM
PLATO REDONDO
22,5 CM - 8 IN^{7/8}

NEW

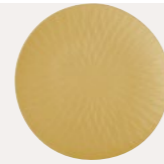

225196*
ASSIETTE À PAIN RONDE
ROUND BREAD & BUTTER PLATE
PLATO DE PAN REDONDO
14 CM - 5 IN^{1/2}

* FABRICATION SUR DEMANDE
AVAILABLE ON REQUEST



225197
**ASSIETTE GOURMET OVALE
PETIT BASSIN**
SHALLOW BOWL W/WIDE OVAL RIM
PLATO GOURMET OVAL FONDO PEQUEÑO
30 X 26 CM - 27 CL - 11 IN^{3/16} X 10 IN^{1/4} - 9 OZ

ARGENT - SILVERPLATED - PLATEADO



225198
ASSIETTE DE PRÉSENTATION
PRESENTATION PLATE W/WIDE RIM
PLATO PRESENTACIÓN
33 CM - 13 IN

NEWPORT CAFÉTERIE - TEATIME - TÉ CAFÉ

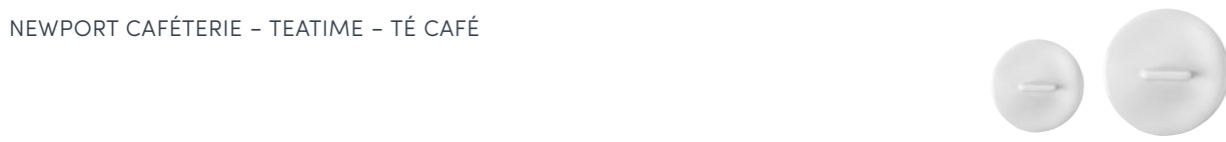

COUVERCLES VERSEUSES
LIDS FOR TEA POTS
TAPAS CAFETERAS
210911 210912
6,6 CM - 2 IN^{5/8} 8,4 CM - 3 IN^{5/16}
40 CL - 13 OZ^{1/2} 80 CL - 27 OZ^{1/16}



207756
TASSE ESPRESSO
DEMITASSE CUP
ESPRESSO TAZA
10 CL - 3 OZ^{2/8}
207759
SOUCOUPE ESPRESSO
DEMITASSE SAUCER
ESPRESSO PLATO
12,5 CM - 4 IN^{5/16}



207757
TASSE LUNGO
COFFEE/TEA CUP
LUNGO TAZA
20 CL - 6 OZ^{3/4}
207760
SOUCOUPE LUNGO
COFFEE/TEA SAUCER
LUNGO PLATO
15,8 CM - 5 IN^{7/16}



207758
TASSE DÉJEUNER
BREAKFAST CUP
TAZA DESAYUNO
40 CL - 13 OZ^{1/2}
207761
SOUCOUPE DÉJEUNER
BREAKFAST SAUCER
PLATO DESAYUNO
18 CM - 7 IN^{7/16}



207763
VERSEUSE
COFFEE/TEA POT
CAFETERA/TETERA
40 CL - 13 OZ^{1/2}



207764
VERSEUSE
COFFEE/TEA POT
CAFETERA/TETERA
80 CL - 27 OZ^{1/16}



207762
CRÉMIER
CREAM JUG
LECHERA
10 CL - 3 OZ^{3/8}



@Julie Anisau

BLANC - WHITE - BLANCO



234342
GRANDE ASSIETTE COCOTTE
LARGE CASSEROLE PLATE
GRANDE COCOTTE/PLATO
22 CM - 8 IN^{11/16}
100 CL - 33 OZ^{13/16}



235064
GRANDE ASSIETTE COCOTTE
LARGE CASSEROLE PLATE
GRANDE COCOTTE/PLATO
18 CM - 7 IN^{7/16}
70 CL - 23 OZ^{11/16}



234341
COCOTTE
ROUND CASSEROLE
COCOTTE/BOL
17,5 CM - 6 IN^{7/8}
140 CL - 47 OZ^{5/16}



209384
ASSIETTE/COUVERCLE DE COCOTTE ROND
ROUND PLATE/CASSEROLE LID
BOL/PLATO PAN RONDO
12,5 CM - 4 IN^{5/16}



234340
BOL
BOWL
BOL
16 CM - 6 IN^{5/16}
100 CL - 33 OZ^{13/16}



186849
BOL
BOWL
BOL
12 CM - 4 IN^{3/4}
30 CL - 10 OZ^{1/8}



211891
MINI BOL
MINI BOWL
MINI BOL
7,3 CM - 2 IN^{7/8}
7 CL - 2 OZ^{3/8}

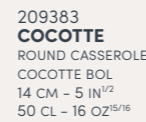

209383
COCOTTE
ROUND CASSEROLE
COCOTTE BOL
14 CM - 5 IN^{1/2}
50 CL - 16 OZ^{5/16}

BLANC SABLÉ - SANDY WHITE - ACABADO COLOR ARENA



234345
GRANDE ASSIETTE COCOTTE
LARGE CASSEROLE PLATE
GRANDE COCOTTE/PLATO
22 CM - 8 IN^{11/16}
100 CL - 33 OZ^{13/16}



235065
GRANDE ASSIETTE COCOTTE
LARGE CASSEROLE PLATE
GRANDE COCOTTE/PLATO
18 CM - 7 IN^{7/16}
70 CL - 23 OZ^{11/16}



234334
COCOTTE
ROUND CASSEROLE
COCOTTE/BOL
17,5 CM - 6 IN^{7/8}
140 CL - 47 OZ^{5/16}



209384
ASSIETTE/COUVERCLE DE COCOTTE ROND
ROUND PLATE/CASSEROLE LID
BOL/PLATO PAN RONDO
12,5 CM - 4 IN^{5/16}



234343
BOL
BOWL
BOL
16 CM - 6 IN^{5/16}
100 CL - 33 OZ^{13/16}



211893
BOL
BOWL
BOL
12 CM - 4 IN^{3/4}
30 CL - 10 OZ^{1/8}



211892
MINI BOL
MINI BOWL
MINI BOL
7,3 CM - 2 IN^{7/8}
7 CL - 2 OZ^{3/8}

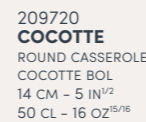

209720
COCOTTE
ROUND CASSEROLE
COCOTTE BOL
14 CM - 5 IN^{1/2}
50 CL - 16 OZ^{5/16}

CARBONE - CARBONE/BLACK - NEGRO



234336
GRANDE ASSIETTE COCOTTE
LARGE CASSEROLE PLATE
GRANDE COCOTTE/PLATO
22 CM - 8 IN^{11/16}
100 CL - 33 OZ^{13/16}



235066
GRANDE ASSIETTE COCOTTE
LARGE CASSEROLE PLATE
GRANDE COCOTTE/PLATO
18 CM - 7 IN^{7/16}
70 CL - 23 OZ^{11/16}



234335
COCOTTE
ROUND CASSEROLE
COCOTTE/BOL
17,5 CM - 6 IN^{7/8}
140 CL - 47 OZ^{5/16}



204042
ASSIETTE/COUVERCLE DE COCOTTE ROND
ROUND PLATE/CASSEROLE LID
BOL/PLATO PAN RONDO
12,5 CM - 4 IN^{5/16}



234334
BOL
BOWL
BOL
16 CM - 6 IN^{5/16}
100 CL - 33 OZ^{13/16}



234209
BOL
BOWL
BOL
12 CM - 4 IN^{3/4}
30 CL - 10 OZ^{1/8}



234208
MINI BOL
MINI BOWL
MINI BOL
7,3 CM - 2 IN^{7/8}
7 CL - 2 OZ^{3/8}



204041
COCOTTE
ROUND CASSEROLE
COCOTTE BOL
14 CM - 5 IN^{1/2}
50 CL - 16 OZ^{5/16}

BLEU - BLUE - AZUL



234339
GRANDE ASSIETTE COCOTTE
LARGE CASSEROLE PLATE
GRANDE COCOTTE/PLATO
22 CM - 8 IN^{11/16}
100 CL - 33 OZ^{13/16}



235063
GRANDE ASSIETTE COCOTTE
LARGE CASSEROLE PLATE
GRANDE COCOTTE/PLATO
18 CM - 7 IN^{7/16}
70 CL - 23 OZ^{11/16}



234338
COCOTTE
ROUND CASSEROLE
COCOTTE/BOL
17,5 CM - 6 IN^{7/8}
140 CL - 47 OZ^{5/16}



230820
ASSIETTE/COUVERCLE DE COCOTTE ROND
ROUND PLATE/CASSEROLE LID
BOL/PLATO PAN RONDO
12,5 CM - 4 IN^{5/16}



234337
BOL
BOWL
BOL
16 CM - 6 IN^{5/16}
100 CL - 33 OZ^{13/16}



230822
BOL
BOWL
BOL
12 CM - 4 IN^{3/4}
30 CL - 10 OZ^{1/8}



230823
MINI BOL
MINI BOWL
MINI BOL
7,3 CM - 2 IN^{7/8}
7 CL - 2 OZ^{3/8}

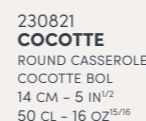

230821
COCOTTE
ROUND CASSEROLE
COCOTTE BOL
14 CM - 5 IN^{1/2}
50 CL - 16 OZ^{5/16}



Finedining

NEW GOURMET

LA VAISSELLE
TABLEWARE - VAJILLA

©Patrick ROUGEREAU

DUNE - BEIGE DUNE - BEIS DUNA



230921
ASSIETTE PLATE
ROUND DINNER PLATE
PLATO REDONDO
29 CM - 11 IN^{7/8}

230920
ASSIETTE PLATE
ROUND DINNER PLATE
PLATO REDONDO
26 CM - 10 IN^{1/4}

230919
ASSIETTE PLATE
ROUND DINNER PLATE
PLATO REDONDO
23 CM - 9 IN^{1/8}



230922
ASSIETTE CREUSE
ROUND DEEP PLATE
PLATO HONDO
20 CM - 7 IN^{7/8}



230918
ASSIETTE À PAIN
ROUND BREAD & BUTTER PLATE
PLATO DE PAN
14 CM - 5 IN^{1/2}



230929
TASSE À ESPRESSO
ESPRESSO CUP
TAZA DE ESPRESSO
11 CL - 3 OZ^{3/4}



230931
TASSE À THÉ
COFFEE/TEA CUP
TAZA DE TÉ
20 CL - 6 OZ^{3/4}



230930
MUG À THÉ
TEA MUG
MUG
38 CL - 12 OZ^{7/8}

BASALTE - BROWN BASALT - BASALTO



230938
ASSIETTE PLATE
ROUND DINNER PLATE
PLATO REDONDO
29 CM - 11 IN^{7/8}

230937
ASSIETTE PLATE
ROUND DINNER PLATE
PLATO REDONDO
26 CM - 10 IN^{1/4}

230936
ASSIETTE PLATE
ROUND DINNER PLATE
PLATO REDONDO
23 CM - 9 IN^{1/8}



230939
ASSIETTE CREUSE
ROUND DEEP PLATE
PLATO HONDO
20 CM - 7 IN^{7/8}



230935
ASSIETTE À PAIN
ROUND BREAD & BUTTER PLATE
PLATO DE PAN
14 CM - 5 IN^{1/2}



230946
TASSE À ESPRESSO
ESPRESSO CUP
TAZA DE ESPRESSO
11 CL - 3 OZ^{3/4}



230948
TASSE À THÉ
COFFEE/TEA CUP
TAZA DE TÉ
20 CL - 6 OZ^{3/4}



230947
MUG À THÉ
TEA MUG
MUG
38 CL - 12 OZ^{7/8}

ARGILE VERTE - GREEN CLAY - ARCILLA VERDE



230952
ASSIETTE PLATE
ROUND DINNER PLATE
PLATO REDONDO
29 CM - 11 IN^{7/8}

230951
ASSIETTE PLATE
ROUND DINNER PLATE
PLATO REDONDO
26 CM - 10 IN^{1/4}

230950
ASSIETTE PLATE
ROUND DINNER PLATE
PLATO REDONDO
23 CM - 9 IN^{1/8}



230953
ASSIETTE CREUSE
ROUND DEEP PLATE
PLATO HONDO
20 CM - 7 IN^{7/8}



230949
ASSIETTE À PAIN
ROUND BREAD & BUTTER PLATE
PLATO DE PAN
14 CM - 5 IN^{1/2}



230960
TASSE À ESPRESSO
ESPRESSO CUP
TAZA DE ESPRESSO
11 CL - 3 OZ^{3/4}



230962
TASSE À THÉ
COFFEE/TEA CUP
TAZA DE TÉ
20 CL - 6 OZ^{3/4}



230961
MUG À THÉ
TEA MUG
MUG
38 CL - 12 OZ^{7/8}



© Patrick ROUGÉREAU

BAHIA

ROSE SABLE - PINK SAND - ROSA ARENA



230904
ASSIETTE PLATE
ROUND DINNER PLATE
PLATO REDONDO
29 CM - 11 IN^{7/8}

230903
ASSIETTE PLATE
ROUND DINNER PLATE
PLATO REDONDO
26 CM - 10 IN^{1/4}

230902
ASSIETTE PLATE
ROUND DINNER PLATE
PLATO REDONDO
23 CM - 9 IN^{1/8}



230905
ASSIETTE CREUSE
ROUND DEEP PLATE
PLATO HONDO
20 CM - 7 IN^{7/8}



230901
ASSIETTE À PAIN
ROUND BREAD & BUTTER PLATE
PLATO DE PAN
14 CM - 5 IN^{1/2}



230912
TASSE À ESPRESSO
ESPRESSO CUP
TAZA DE ESPRESSO
11 CL - 3 OZ^{3/4}



230914
TASSE À THÉ
COFFEE/TEA CUP
TAZA DE TÉ
20 CL - 6 OZ^{3/4}



230913
MUG À THÉ
TEA MUG
MUG
38 CL - 12 OZ^{7/8}

BLEU DE ROCHE - BLUE STONE - AZUL DE ROCA

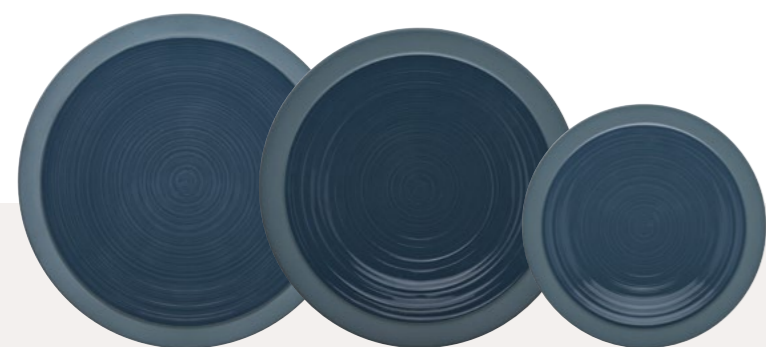

230966
ASSIETTE PLATE
ROUND DINNER PLATE
PLATO REDONDO
29 CM - 11 IN^{7/8}

230965
ASSIETTE PLATE
ROUND DINNER PLATE
PLATO REDONDO
26 CM - 10 IN^{1/4}

230964
ASSIETTE PLATE
ROUND DINNER PLATE
PLATO REDONDO
23 CM - 9 IN^{1/8}



230967
ASSIETTE CREUSE
ROUND DEEP PLATE
PLATO HONDO
20 CM - 7 IN^{7/8}



230963
ASSIETTE À PAIN
ROUND BREAD & BUTTER PLATE
PLATO DE PAN
14 CM - 5 IN^{1/2}



230974
TASSE À ESPRESSO
ESPRESSO CUP
TAZA DE ESPRESSO
11 CL - 3 OZ^{3/4}



230976
TASSE À THÉ
COFFEE/TEA CUP
TAZA DE TÉ
20 CL - 6 OZ^{3/4}



230975
MUG À THÉ
TEA MUG
MUG
38 CL - 12 OZ^{7/8}



DUNE - BEIGE DUNE - BEIS DUNA



BASALTE - BROWN BASALT - BASALTO



ARGILE VERTE - GREEN CLAY - ARCILLA VERDE



BLEU DE ROCHE - BLUE STONE - AZUL DE ROCA



ROSE SABLE - PINK SAND - ROSA ARENA



ASSIETTE/COUVERCLE DE COCOTTE ROND
ROUND PLATE/CASSEROLE LID
BOL/PLATO RONDO PAN
12,5 CM - 4 IN^{5/16}

COCOTTE
ROUND CASSEROLE
COCOTTE BOL
14 CM - 5 IN^{1/2}
50 CL - 16 OZ^{5/16}

ASSIETTE GOURMET GRAND BASSIN
SHALLOW BOWL W/WIDE ROUND RIM
PLATO GOURMET HONDO FONDO GRANDE
26 CM - 10 IN^{1/4}

BOL
BOWL
BOL
12 CM - 4 IN^{3/4}
30 CL - 10 OZ^{2/8}

ASSIETTE GOURMET PETIT BASSIN
SHALLOW BOWL W/WIDE ROUND RIM
PLATO GOURMET REDONDO FONDO PEQUEÑO
23 CM - 9 IN^{1/8}



206504
BOUCHON PORCELAINE POUR CLOCHE VERRE
PORCELAIN LID FOR GLASS DOME COVER
TAPA DE PORCELANA PARA CAMPANA DE VIDRIO
5,2 CM - 2 IN^{17/16}

204043
CLOCHE VERRE BOROSILICATE
GLASS DOME COVER
CAMPANA VIDRIO BOROSILICATO
17X9 CM - 6 IN^{17/16} X 3 IN^{9/16}

182614
CLOCHE INOX
DOME COVER, STAINLESS STEEL
CAMPANA
24 CM - Ø 9 IN^{7/16}

182301
CLOCHE INOX
DOME COVER, STAINLESS STEEL
CAMPANA
14,8 CM - Ø 5 IN^{13/16}

MODULO NATURE

PIERRE DE LAVE - LAVA STONE - PIEDRA DE LAVA



NEW

194455
ASSIETTE DE PRÉSENTATION
PRESENTATION PLATE, COUPE
PLATO PRESENTACIÓN
31,5 CM - 12 IN^{3/8}

194454
ASSIETTE PLATE
DINNER PLATE, COUPE
PLATO REDONDO
28 CM - 11 IN

194453
ASSIETTE DESSERT
DESSERT/SALAD PLATE, COUPE
PLATO ILANO
21 CM - 8 IN^{1/4}

234455
COUPE RONDE
ROUND CUP
BOL
25 CM - 9 IN^{13/16}

194452
ASSIETTE CALOTTE
SALAD/CEREAL PLATE
PLATO HONDO
21 CM - 8 IN^{1/4}

230092
ASSIETTE À PAIN
BREAD & BUTTER PLATE, COUPE
PLATO DE PAN
16 CM - 6 IN^{5/16}



194462
SALADIER
SALAD BOWL, DEEP
ENSALADERA
24 CM - 9 IN^{2/16}
H : 8 CM - 3 IN^{3/16}



194457
COUPE/CALOTTE
SALAD /CEREAL PLATE, DEEP
BOL
17,7 CM - 6 IN^{15/16}
H : 5,5 CM - 2 IN^{3/16}



194456
BOL À DEJEUNER
SOUP/BREAKFAST BOWL
BOL DESAYUNO
14 CM - 58 CL
5 IN^{1/2} - 19 OZ^{5/8}



194458
COUPELLE
SMALL BOWL, CUP
BOL PEQUEÑO
10 CM - 3 IN^{15/16}
H : 6 CM - 2 IN^{3/8}



194459
TASSE À CAFÉ
DEMITASSE CUP
TAZA DE CAFÉ
11,5 CL - 3 OZ^{7/16}

194460
SOUCOUPE À CAFÉ
DEMITASSE SAUCER
ESPRESSO CAFÉ
12,5 CM - 4 IN^{15/16}



230093
TASSE À THÉ
TEA CUP
TAZA DE TÉ
25 CL - 8 OZ^{2/16}

230094
SOUCOUPE À THÉ
DEMITASSE /TEA SAUCER
PLATO TÉ
15 CM - 5 OZ^{2/16}



194461
MUG À THÉ
MUG
TÈ MUG
33 CL - 11 OZ^{3/16}



MODULO NATURE

BLEU GALET - BLUE - AZUL



225342
ASSIETTE DE PRÉSENTATION
PRESENTATION PLATE, COUPE
PLATO PRESENTACIÓN
31,5 CM - 12 IN^{3/8}

225343
ASSIETTE PLATE
DINNER PLATE, COUPE
PLATO REDONDO
28 CM - 11 IN

225344
ASSIETTE DESSERT
DESSERT SALAD PLATE, COUPE
PLATO ILANO
21 CM - 8 IN^{1/4}



225345
ASSIETTE CALOTTE
SALAD /CEREAL PLATE
PLATO HONDO
21 CM - 8 IN^{1/4}

225353
ASSIETTE À PAIN
BREAD & BUTTER PLATE, COUPE
PLATO DE PAN
16 CM - 6 IN^{5/16}



225349
SALADIER
SALAD BOWL, DEEP
ENSALADERA
24 CM - 9 IN^{7/16}
H : 8 CM - 3 IN^{3/16}

225347
COUPE/CALOTTE
SALAD /CEREAL PLATE, DEEP
BOL
17,7 CM - 6 IN^{15/16}
H : 5,5 CM - 2 IN^{3/16}

225346
COUPELLE
SMALL BOWL, CUP
BOL PEQUEÑO
10 CM - 3 IN^{5/16}
H : 6 CM - 2 IN^{3/8}



225351
TASSE À CAFÉ
DEMITASSE CUP
TAZA DE CAFÉ
11,5 CL - 3 OZ^{7/8}

225352
SOUCOUPE À CAFÉ
DEMITASSE SAUCER
PLATO CAFÉ
12,5 CM - 4 IN^{15/16}

230167
TASSE À THÉ
COFFEE/TEA CUP
TAZA DE TÉ
25 CL - 8 OZ^{7/16}

230168
SOUCOUPE À THÉ
DEMITASSE /TEA SAUCER
PLATO TÉ
15 CM - 5 OZ^{7/8}

KAOLIN - CAOLÍN



184088
ASSIETTE DE PRÉSENTATION
PRESENTATION PLATE, COUPE
PLATO PRESENTACIÓN
31,5 CM - 12 IN^{3/8}

184077
ASSIETTE PLATE
DINNER PLATE, COUPE
PLATO REDONDO
28 CM - 11 IN

184078
ASSIETTE DESSERT
DESSERT SALAD PLATE, COUPE
PLATO ILANO
21 CM - 8 IN^{1/4}



NEW

234449
COUPE RONDE
ROUND CUP
BOL
25 CM - 9 IN^{13/16}

184079
ASSIETTE CALOTTE
SALAD CEREAL PLATE, COUPE
PLATO HONDO
21 CM - 8 IN^{1/4}



209092
ASSIETTE À PAIN
BREAD & BUTTER PLATE, COUPE
PLATO DE PAN
16 CM - 6 IN^{5/16}



184087
SALADIER
SALAD BOWL, DEEP
ENSALADERA
24 CM - 9 IN^{7/16}
H : 8 CM - 3 IN^{3/16}

184086
COUPE/CALOTTE
SALAD /CEREAL PLATE, DEEP
BOL
17,7 CM - 6 IN^{15/16}
H : 5,5 CM - 2 IN^{3/16}

184084
BOL À DÉJEUNER
SOUP /BREAKFAST BOWL
BOL DESAYUNO
14 CM - 5 IN^{1/2}
58 CL - 19 OZ^{5/8}

184085
COUPELLE
SMALL BOWL, CUP
BOL PEQUEÑO
10 CM - 3 IN^{5/16}
H : 6 CM - 2 IN^{3/8}

184083
MUG À THÉ
MUG
TÈ MUG
33 CL - 11 OZ^{3/16}

184081
TASSE À CAFÉ
DEMITASSE CUP
TAZA DE CAFÉ
11,5 CL - 3 OZ^{7/8}

184082
SOUCOUPE À CAFÉ
DEMITASSE SAUCER
PLATO CAFÉ
12,5 CM - 4 IN^{15/16}



230164
TASSE À THÉ
COFFEE/TEA CUP
TAZA DE TÉ
25 CL - 8 OZ^{7/16}

230163
SOUCOUPE À THÉ
DEMITASSE /TEA SAUCER
PLATO TÉ
15 CM - 5 OZ^{7/8}

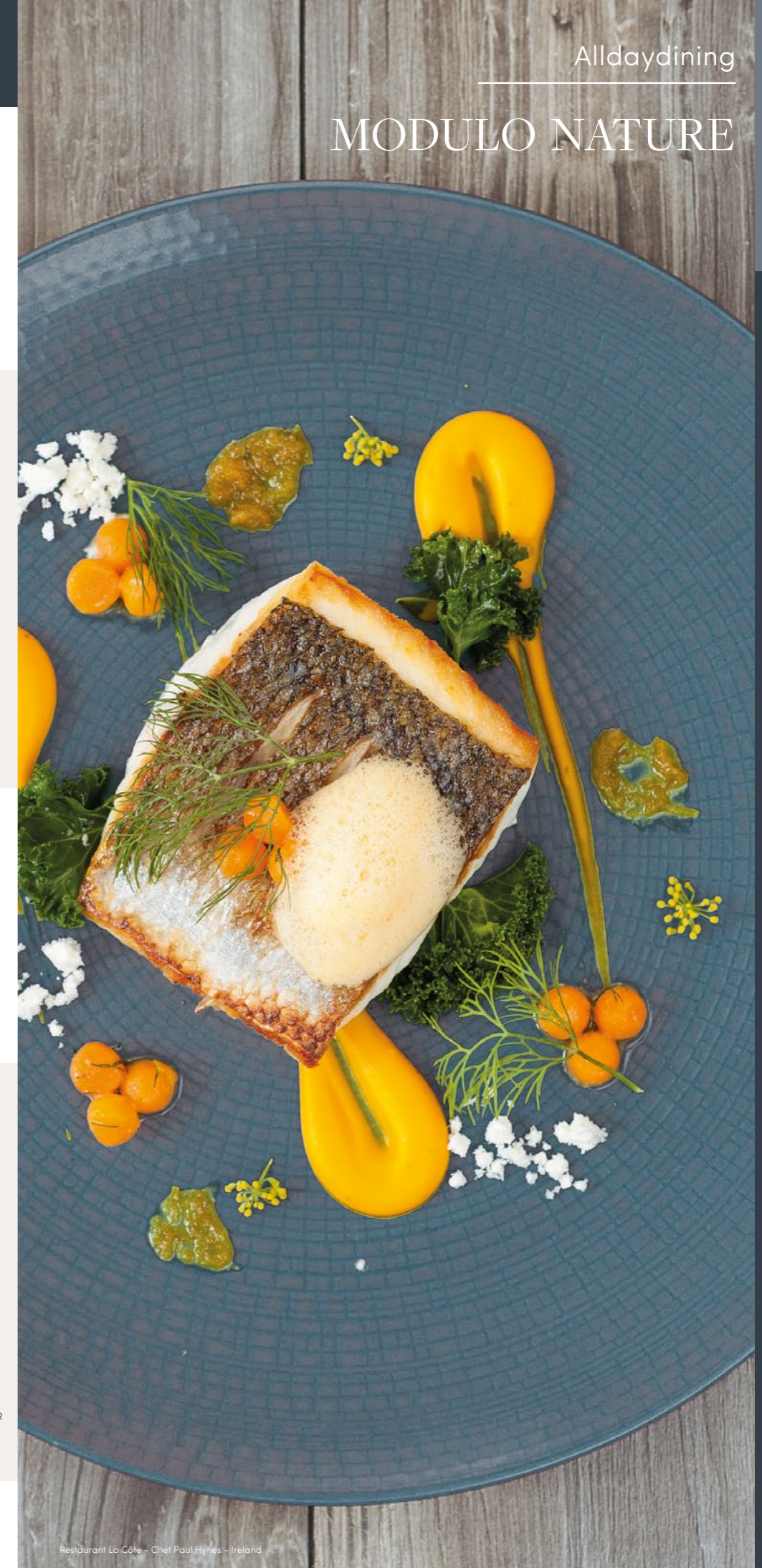

Restaurant La Côte - Chef Paul Hynes - Ireland

MODULO NATURE

TERRE D'OMBRE - TAUPE - TIERRA DE SOMBRA



184101
ASSIETTE DE PRÉSENTATION
PRESENTATION PLATE, COUPE
PLATO PRESENTACIÓN
31,5 CM - 12 IN^{3/8}

184090
ASSIETTE PLATE
DINNER PLATE, COUPE
PLATO REDONDO
28 CM - 11 IN

184091
ASSIETTE DESSERT
DESSERT SALAD PLATE, COUPE
PLATO ILANO
21 CM - 8 IN^{1/4}



234451
COUPE RONDE
ROUND CUP
BOL
25 CM - 9 IN^{3/8}

184092
ASSIETTE CALOTTE
SALAD CEREAL PLATE, COUPE
PLATO HONDO
21 CM - 8 IN^{1/4}



209093
ASSIETTE À PAIN
BREAD & BUTTER PLATE, COUPE
PLATO DE PAN
16 CM - 6 IN^{5/8}



184100
SALADIER
SALAD BOWL, DEEP
ENSALADERA
24 CM - 9 IN^{7/8}
H : 8 CM - 3 IN^{3/8}



184099
COUPE/CALOTTE
SALAD /CEREAL PLATE, DEEP
BOL
17,7 CM - 6 IN^{5/8}
H : 5,5 CM - 2 IN^{3/8}



184097
BOL À DÉJEUNER
SOUP /BREAKFAST BOWL
BOL DESAYUNO
14 CM - 5 IN^{1/2}
58 CL - 19 OZ^{5/8}



184098
COUPELLE
SMALL BOWL, CUP
BOL PEQUEÑO
10 CM - 3 IN^{5/8}
H : 6 CM - 2 IN^{3/8}



184096
MUG À THÉ
MUG
TÉ MUG
33 CL - 11 OZ^{3/8}



184094
TASSE À CAFÉ
DEMITASSE CUP
TAZA DE CAFÉ
11,5 CL - 3 OZ^{7/8}

184095
SOUCOUBE À CAFÉ
DEMITASSE SAUCER
ESPRESSO CAFÉ
12,5 CM - 4 IN^{5/8}



230165
TASSE À THÉ
TEA CUP
TAZA DE TÉ
25 CL - 6 OZ^{3/4}

230166
SOUCOUBE À THÉ
DEMITASSE /TEA SAUCER
PLATO TÉ
15 CM - 5 OZ^{7/8}

TOMETTE - RED - ROJO



184101
ASSIETTE DE PRÉSENTATION
PRESENTATION PLATE, COUPE
PLATO PRESENTACIÓN
31,5 CM - 12 IN^{3/8}

205270
ASSIETTE PLATE
DINNER PLATE, COUPE
PLATO REDONDO
28 CM - 11 IN

205271
ASSIETTE DESSERT
DESSERT SALAD PLATE, COUPE
PLATO ILANO
21 CM - 8 IN^{1/4}



205272
ASSIETTE CALOTTE
SALAD CEREAL PLATE, COUPE
PLATO HONDO
21 CM - 8 IN^{1/4}



209094
ASSIETTE À PAIN
BREAD & BUTTER PLATE, COUPE
PLATO DE PAN
16 CM - 6 IN^{5/8}



184100
SALADIER
SALAD BOWL, DEEP
ENSALADERA
24 CM - 9 IN^{7/8}
H : 8 CM - 3 IN^{3/8}



205274
COUPE/CALOTTE
SALAD /CEREAL PLATE, DEEP
BOL
17,7 CM - 6 IN^{5/8}
H : 5,5 CM - 2 IN^{3/8}



205275
COUPELLE
SMALL BOWL, CUP
BOL PEQUEÑO
10 CM - 3 IN^{5/8}
H : 6 CM - 2 IN^{3/8}



222022
TASSE À CAFÉ
DEMITASSE CUP
TAZA DE CAFÉ
11,5 CL - 3 OZ^{7/8}

222023
SOUCOUBE À CAFÉ
DEMITASSE SAUCER
ESPRESSO CAFÉ
12,5 CM - 4 IN^{5/8}



VERT SHISHO - SHISHO GREEN - VERDE SHISHO



ROUGE PIMENT - RED CHILI - ROJO PIMIENTO



CRISTAUX DE SEL - SALT WHITE - CRISTALES DE SAL



BLEU INDIGO - INDIGO BLUE - AZUL AÑIL



ASSIETTE À PARTAGER RONDE

ROUND SHARED PLATE
PLATO PARA COMPARTIR
20 CM - 7 IN^{7/8}

ASSIETTE PLATE RONDE

ROUND DINNER PLATE
PLATO REDONDO
26 CM - 10 IN^{1/4}

COUPELLE RONDE

ROUND SMALL BOWL
BOL PEQUEÑO
33 CL - 11 OZ^{3/16}

GRANDES ASSIETTES CREUSES RONDDES

ROUND LARGE DEEP PLATES
GRANDE PLATO REDONDO
22,5 CM - 8 IN^{7/8}
1L - 33 OZ^{13/16}

24 CM - 9 IN^{7/16}
1,25L - 42 OZ^{1/4}

BOL

BOWL
BOL
19 CM - 7 IN^{1/2}
1,1 L - 37 OZ^{3/16}



Alldaydining

NEW MONDO

LA VAISSELLE
TABLEWARE - VAJILLA



© Patrick ROUGEREAU

VIN DE FRANCE
IGP PAYS D'OC CÉPAGE
PETIT CHABLIS AOP
CÔTES DU ROUSSILLON AOP
SAINT-EMILION AOP
QUINCY AOP

VIN DE FRANCE
IGP PAYS D'OC CÉPAGE
CÔTES DE PROVENCE AOP
BANDOL AOP
SÈVRES-ET-MORVAN AOP

VIN DE FRANCE
IGP PAYS D'OC CÉPAGE
CÔTES DU ROUSSILLON AOP
BORDEAUX AOP
SAINT-EMILION AOP
SAINT-JULIEN AOP
BEAUNE AOP

NEWMOON



207126
ASSIETTE PLATE
PRESENTATION PLATE
PLATO PRESENTACIÓN
32 CM - 12 IN^{5/8}



207125
ASSIETTE PLATE
DINNER PLATE
PLATO
28 CM - 11 IN



207127
ASSIETTE DESSERT
DESSERT/SALAD/APP. PLATE
PLATO
24 CM - 9 IN^{7/16}



207124
ASSIETTE À PAIN
BREAD & BUTTER PLATE
PLATO
16 CM - 6 IN^{5/16}



198047
SALADIER/BOL
DEEP BOWL, SOUP/SALAD
ENSALADERA
20 CM - 7 IN^{7/8}



© Patrick FOUGEREAU

L'ABUS D'ALCOOL EST DANGEREUX POUR LA SANTÉ
DEGRENNÉ PROMOTES RESPONSIBLE DRINKING AND DISCOURAGES ALCOHOL MISUSE
EL ABUSO DE ALCOHOL ES PELIGROSO PARA LA SALUD





161009
ASSIETTE PLATE
PRESENTATION PLATE
PLATO PRESENTACIÓN
28 CM - 11 IN



NEW
161008
ASSIETTE PLATE
DINNER PLATE
PLATO
24 CM - 9 IN^{5/16}



161038
ASSIETTE PLATE
BREAD & BUTTER PLATE
PLATO REDONDO
16 CM - 6 IN^{5/16}



161012
ASSIETTE CREUSE
SHALLOW COUPE BOWL, LARGE
PLATO HONDO
30 CM - 11 IN^{13/16}



161011
ASSIETTE CREUSE
SHALLOW COUPE BOWL, MEDIUM
PLATO HONDO
23 CM - 9 IN^{1/16}



161016
SALADIER
DEEP BOWL, LARGE
ENSALADERA
32 CM - 12 IN^{5/8}
CONTENANCE : 250 CL
CAPACITY : 84 OZ^{9/16}
H : 14 CM - 5 IN^{1/2}



161015
SALADIER
DEEP BOWL, MEDIUM
ENSALADERA
25 CM - 9 IN^{13/16}
CONTENANCE : 150 CL
CAPACITY : 50 OZ^{3/4}
H : 11,5 CM - 4 IN^{1/4}



161014
SALADIER/BOL
DEEP BOWL, INDIVIDUAL
BOL
16,5 CM - 6 IN^{1/2}
CONTENANCE : 50 CL
CAPACITY : 16 OZ^{15/16}
H : 9 CM - 3 IN^{5/16}



161013
SALADIER/BOL
DEEP BOWL, CUP
BOL
9 CM - 3 IN^{9/16}
CONTENANCE : 20 CL
CAPACITY : 6 OZ^{3/4}
H : 7 CM - 2 IN^{9/16}



161020
COQUETIER
EGG CUP, PLATE
HUEVERA
15 CM - 5 IN^{7/8}



161037
RAVIER
SHALLOW RAMEKIN, COUPE
BOL
10 CM - 3 IN^{15/16}
H : 4 CM - 1 IN^{3/8}



161036
SUPPORT PLATEAU
TRAY STAND, 3 PLACES
FUENTE CON 3 ESPACIOS
30,5 X 10 CM - 12 IN X 3 IN^{5/16}



198017
POT À SAUCE/GARNITURE
RAMEKIN, LARGE
POT
48 CL - 16 OZ^{1/4}
Ø 10,5 CM - 4 IN^{1/8}
H : 8 CM - 2 IN^{1/16}



198016
POT À SAUCE/GARNITURE
RAMEKIN, SMALL
POT
20 CL - 6 OZ^{3/4}
Ø 8 CM - 3 IN^{1/8}
H : 7 CM - 2 IN^{9/16}



196561
POT À SAUCE/GARNITURE
RAMEKIN, SMALL
POT
7,5 CL - 2 OZ^{9/16}
Ø 5,5 CM - 2 IN^{3/16}
H : 6,5 CM - 2 IN^{9/16}



214688
SOUCOUBE UNIVERSELLE
UNIVERSAL SAUCER CUP
PLATO UNIVERSAL
13 CM - 5 IN^{1/8}



207766
TASSE À ESPRESSO
ESPRESSO CUP
ESPRESSO DE TAZA
6 CL - 2 OZ



161025
SOUCOUBE À CAFÉ/ESPRESSO
DEMITASSE/ESPRESSO SAUCER
ESPRESSO DE PLATO
15 CM - 5 IN^{7/8}



208948
TASSE À CAFÉ
DEMITASSE CUP
TAZA DE CAFÉ
11 CL - 3 OZ^{3/4}



207767
TASSE À THÉ/LUNGO
COFFEE/TEA CUP
LUNGO DE TAZA
20 CL - 6 OZ^{3/4}



161028
SOUCOUBE À THÉ/LUNGO
COFFEE/TEA SAUCER
LUNGO DE PLATO
18 CM - 7 IN^{1/16}



207768
TASSE À DÉJEUNER
BREAKFAST CUP
TAZA DESAYUNO
48 CL - 16 OZ^{1/4}



161034
SOUCOUBE À DÉJEUNER
BREAKFAST SAUCER
PLATO DESAYUNO
21 CM - 8 IN^{1/4}



207765
MUG
MUG, LARGE
MUG
50 CL - 16 OZ^{15/16}



209189
MUG
MUG
MUG
30 CL - 10 OZ^{1/8}

BLANC ROND - ROUND WHITE - BLANCO REDONDO



- 207120 **ASSIETTE DE PRÉSENTATION**
PRESENTATION COUPE PLATE
PLATO PRESENTACIÓN
32 CM - 12 IN^{5/8}
- 207112 **ASSIETTE PLATE**
DINNER COUPE PLATE
PLATO REDONDO
29 CM - 11 IN^{7/16}
- 207113 **ASSIETTE PLATE**
DINNER COUPE PLATE
PLATO REDONDO
26 CM - 10 IN^{1/4}
- 207111 **ASSIETTE DESSERT**
DESSERT/SALAD/APP.COUPPE PLATE
PLATO REDONDO
20 CM - 7 IN^{7/8}
- 207119 **ASSIETTE À PAIN**
BREAD & BUTTER COUPE PLATE
PLATO DE PAN
15 CM - 5 IN^{7/8}
- 188537 **BOL À SOUPE**
MED BOWL, SOUP
BOL HONDO
13 CM - 5 IN^{1/8}
H : 6 CM - 2 IN^{3/8}
- 207114 **ASSIETTE CREUSE/CALOTTE**
ROUND SHALLOW BOWL
PLATO HONDO
20 CM - 7 IN^{7/8}



- 142722 **BOL**
DEEP BOWL, LARGE
BOL HONDO
28 CM - 11 IN
CONTENANCE : 2,5 L
CAPACITY : 84 OZ^{5/8}
H : 12 CM - 4 IN^{3/4}
- 136529 **BOL**
DEEP BOWL, MEDIUM
BOL HONDO
24 CM - 9 IN^{7/16}
CONTENANCE : 2 L
CAPACITY : 67 OZ^{5/8}
H : 11 CM - 4 IN^{1/4}
- 136511 **BOL**
DEEP BOWL, MEDIUM
BOL HONDO
20 CM - 7 IN^{7/8}
CONTENANCE : 1,30 L
CAPACITY : 43 OZ^{5/16}
H : 9,5 CM - 3 IN^{3/4}
- 136528 **BOL**
DEEP BOWL, INDIVIDUAL
BOL HONDO
16 CM - 6 IN^{5/16}
CONTENANCE : 67 CL
CAPACITY : 22 OZ^{5/16}
H : 7,5 CM - 2 IN^{15/16}
- 154245 **BOL**
DEEP BOWL, SOUP
BOL HONDO
14 CM - 5 IN^{1/2}
CONTENANCE : 55 CL
CAPACITY : 18 OZ^{5/8}
H : 8 CM - 2 IN^{11/16}
- 136510 **BOL**
DEEP BOWL, RICE
BOL HONDO
12 CM - 4 IN^{3/4}
CONTENANCE : 27 CL
CAPACITY : 9 OZ^{1/8}
H : 5,5 CM - 2 IN^{3/16}
- 136509 **BOL**
DEEP BOWL, RAMEKIN
BOL HONDO
8 CM - 3 IN^{1/8}
CONTENANCE : 8 CL
CAPACITY : 3 OZ^{1/8}
H : 4,5 CM - 1 IN^{3/4}



- 136535 **COUPE**
PASTA/SALAD/SEAFOOD BOWL,
FOOTED
BOL
24 CM - 9 IN^{7/16}
H : 11 CM - 4 IN^{1/4}
- 136532 **COUPE**
SHALLOW BOWL, FOOTED
BOL
16 CM - 6 IN^{5/16}
H : 7,5 CM - 2 IN^{15/16}
- 136530 **COUPE**
SHALLOW BOWL, FOOTED
BOL
8 CM - 3 IN^{1/8}
H : 2,5 CM - 1 IN



- 233841 **BOL CONIQUE**
CONIC BOWL
BOL CÓNICO
30 CL - 10 OZ^{1/8}
- 233842 **BOL CONIQUE**
CONIC BOWL
BOL CÓNICO
1,15 L - 38 OZ^{7/8}

GRIS PERLE - LIGHT GREY - GRIS PERLA



- 230142 **BOL**
DEEP BOWL, MEDIUM
BOL HONDO
24 CM - 9 IN^{7/16}
CONTENANCE : 2 L
CAPACITY : 67 OZ^{5/8}
H : 11 CM - 4 IN^{1/4}
- 230141 **BOL**
DEEP BOWL, MEDIUM
BOL HONDO
20 CM - 7 IN^{7/8}
CONTENANCE : 1,30 L
CAPACITY : 43 OZ^{5/16}
H : 9,5 CM - 3 IN^{3/4}
- 230140 **BOL**
DEEP BOWL, INDIVIDUAL
BOL HONDO
16 CM - 6 IN^{5/16}
CONTENANCE : 67 CL
CAPACITY : 22 OZ^{5/16}
H : 7,5 CM - 2 IN^{15/16}
- 230139 **BOL À DÉJEUNER**
SOUP/BREAKFAST BOWL
BOL DESAYUNO
14 CM - 5 IN^{1/2}
CONTENANCE : 55 CL
CAPACITY : 18 OZ^{5/8}
H : 8 CM - 2 IN^{11/16}
- 230138 **BOL À THÉ**
TEA BOWL, RAMEKIN
BOL HONDO
9 CM - 3 IN^{9/16}
CONTENANCE : 20 CL
CAPACITY : 6 OZ^{3/4}
H : 4,5 CM - 1 IN^{3/4}



CARRÉE - SQUARE PLATE - PLATO CUADRADO



207118
ASSIETTE DE PRÉSENTATION
PRESENTATION COUPE PLATE
PLATO PRESENTACIÓN
28 CM - 11 IN



207115
ASSIETTE PLATE
DINNER COUPE PLATE
PLATO
24 CM - 9 IN^{7/16}



207117
ASSIETTE DESSERT
DESSERT/SALAD/APP. COUPE PLATE
PLATO
20 CM - 7 IN^{7/8}



207123
ASSIETTE À PAIN
BREAD & BUTTER COUPE PLATE
PLATO DE PAN
14 CM - 5 IN^{1/2}

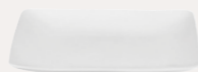

207116
ASSIETTE CREUSE
SOUP/SALAD, COUPE PLATE
PLATO HONDO CUADRADO
20 CM - 7 IN^{7/8}



149831
PLAT CREUX
SQUARE DEEP DISH, COUPE
PLATO HONDO
28 CM - 11 IN
H : 5,5 CM - 2 IN^{3/16}



154244
PLAT CREUX
SQUARE DEEP DISH, COUPE
PLATO HONDO
16 CM - 6 IN^{5/16}
H : 6 CM - 2 IN^{3/8}



136502
COUPE
SQUARE BOWL, FOOTED COUPE
BOL
12 CM - 4 IN^{3/4}
H : 3,5 CM - 1 IN^{3/8}



136503
COUPE
SQUARE BOWL, FOOTED COUPE
BOL
8 CM - 3 IN^{1/8}
H : 2,5 CM - 1 IN



181483
BOL CARRÉ
SQUARE BOWL, DEEP
BOL HONDO
12 CM - 4 IN^{3/4}
H : 3,5 CM - 1 IN^{3/8}

RECTANGULAIRE - RECTANGULAR PLATE - PLATO RECTANGULAR



181485
ASSIETTE PLATE
PRESENTATION COUPE PLATE
PLATO RECTANGULAR
34X26 CM - 13 IN^{3/8} X 10 IN^{1/4}



207122
ASSIETTE PLATE
DINNER COUPE PLATE
PLATO RECTANGULAR
30X22 CM - 11 IN^{13/16} X 8 IN^{1/16}



207110
ASSIETTE DESSERT
DESSERT/SALAD/APP COUPE PLATE
PLATO RECTANGULAR
26X18 CM - 10 IN^{1/4} X 7 IN^{1/16}

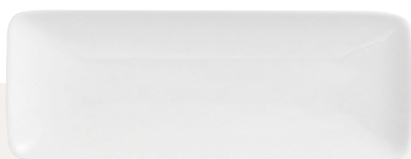

207754
PLAT RECTANGULAIRE
RECTANGULAR DISH, COUPE LARGE
PLATO RECTANGULAR
40X16 CM - 15 IN^{3/4} X 6 IN^{5/16}



207753
PLAT RECTANGULAIRE
RECTANGULAR DISH, COUPE LARGE
PLATO RECTANGULAR
20X12 CM - 7 IN^{7/8} X 4 IN^{3/4}

ACCESSOIRES - ACCESSORIES - ACCESORIOS



209382
PRÉSENTOIR À GÂTEAUX
ROUND APP/PIZZA/PRESENTATION STAND
EXPOSITOR DE TARTAS
32 CM - 12 IN^{5/16}
H : 10,5 CM - 4 IN^{1/4}



209381
PRÉSENTOIR À GÂTEAUX
ROUND APP/PIZZA/PRESENTATION STAND
EXPOSITOR DE TARTAS
25 CM - 9 IN^{13/16}
H : 8,5 CM - 2 IN^{3/16}



136524
PLAT À TARTE
PIE/PIZZA PLATE, FLAT
FUENTE PARA PASTEL
32 CM - 12 IN^{5/8}



181490
VERRINE PORCELAIN
RAMEKIN
VASITO PORCELANA
8 CL - 2 OZ^{1/16}



182915
COFFRET SALIÈRE/POIVRIÈRE
SALT & PEPPER CRUET
SALERO Y PIMENTERO

NEWCOOK MODULO



162015
RAMEQUIN
RAMEKIN
RAMEKIN
9,5 CM - 3 IN^{3/4}



162013
BOL À CONSOMÉ
SOUP BOWL
BOL CONSOMÉ
10,5 CM - 4 IN^{9/16}
50 CL - 16 OZ^{15/16}



162011
ASSIETTE À CRÈME BRÛLÉE
«CRÈME BRÛLÉE» DISH
PLATO PARA GRATINAR
14 CM - 5 IN^{1/2}



164138
PLAT À ESCARGOTS 6 PLACES
SNAIL TRAY 6 SPACES
BANDEJA CARACOLAS 6 COMPARTIMENTOS
16,6 X 11,2 CM - 6 IN^{9/16} X 4 IN^{7/16}





207131
**ASSIETTE PLATE RECTANGLE
6 COMPARTIMENTS**
RECTANGULAR DINNER PLATE
6 COMPARTMENTS
PLATO RECTANGULAR/6 COMPARTIMENTOS
27X18 CM - 10 IN^{5/8} X 7 IN^{1/2}

207133
SOUCOUPE RECTANGULAIRE
RECTANGULAR PLATE/ SAUCER
PLATO RECTANGULAR
27X9 CM - 10 IN^{5/8} X 3 IN^{9/16}



©Patrick ROUGEREAU



234605
ASSIETTE DE PRÉSENTATION
PRESENTATION PLATE
PLATO PRESENTACIÓN
32 CM - 12 IN^{5/8}



234612
ASSIETTE DE PRÉSENTATION
PRESENTATION PLATE
PLATO PRESENTACIÓN
30 CM - 11 IN^{13/16}



234607
ASSIETTE PLATE
DINNER PLATE
PLATO REDONDO
26,5 CM - 10 IN^{7/16}



234608
ASSIETTE DESSERT
DESSERT PLATE
PLATO ILANO
21,5 CM - 8 IN^{7/16}



234611
ASSIETTE DESSERT
DESSERT PLATE
PLATO ILANO
18,5 CM - 7 IN^{5/16}

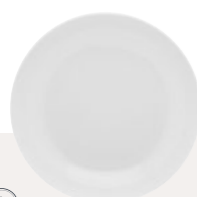

234609
ASSIETTE CREUSE CALOTTE
CEREAL PLATE
PLATO HONDO
19 CM - 7 IN^{1/2}

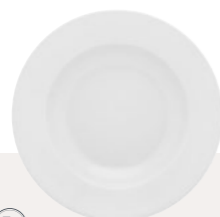

234610
ASSIETTE CREUSE BORD À AILE
ROUND DEEP PLATE
PLATO HONDO
22,5 CM - 8 IN^{7/16}



234603
ASSIETTE À PAIN
BREAD PLATE
PLATO DE PAN
16 CM - 6 IN^{5/16}



234604
BOL À SALADE AVEC AILE
SALAD BOWL WITH RIM
BOL DE ENSALADA CON ALETA
17,5 CM - 6 IN^{7/16}



234606
PLAT OVALE
OVAL DISH
FUENTE OVALADO
36,5 X 26,5 CM - 14 IN^{3/8} X 10 IN^{7/16}



L'ABUS D'ALCOOL EST DANGEREUX POUR LA SANTÉ
DEGRENE PROMOTES RESPONSIBLE DRINKING AND DISCOURAGES ALCOHOL MISUSE
EL ABUSO DE ALCOHOL ES PELIGROSO PARA LA SALUD

PORCELAIN BLANCHE - WHITE PORCELAIN - PORCELANA BLANCO



216529
ASSIETTE ULTRA PLATE RONDE
ROUND ULTRA PLATE
PLATO SÚPER PLANO
25 CM - 9 IN^{3/16}



216531
ASSIETTE ULTRA PLATE RONDE
ROUND ULTRA PLATE
PLATO SÚPER PLANO
12 CM - 4 IN^{3/4}



216536
ASSIETTE À CRÈME BRÛLÉE
«CRÈME BRÛLÉE» ROUND PLATE
PLATO PARA GRATINAR
13,5 CM - 5 IN^{5/16}



216532
ASSIETTE OBLONGUE
OBLONG PLATE
PLATO OBLANGA
32 X 19 CM - 12 IN^{5/8} X 7 IN^{1/2}



216530
ASSIETTE À SALADE RONDE AVEC PIED
FOOTED ROUND DEEP PLATE
PLATO DE ENSALADA CON PIE
20 CM - 7 IN^{7/8}



216535
COUPELLE RONDE AVEC PIED
FOOTED ROUND DEEP PLATE
BOL PEQUEÑO CON PIE
14 CM - 5 IN^{1/2}



216534
COUPELLE RONDE AVEC PIED
FOOTED ROUND DEEP PLATE
BOL PEQUEÑO CON PIE
12 CM - 4 IN^{3/4}

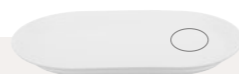

216533
ASSIETTE OBLONGUE
OBLONG PLATE
PLATO OBLANGA
20 X 12 CM - 7 IN^{7/8} X 4 IN^{3/4}

GRÈS GRIS - GRES STONEWARE - ARENISCA



198935
PLAT À GRATIN ROND
ROUND CASSEROLE PLATE
PLATO PARA GRATINAR
14 CM - 5 IN^{1/2}



198939
BOL À CONSOMÉ
SOUP BOWL
BOL CONSOMÉ
13 CM - 5 IN^{1/8}



198936
GOBELET ROND
ROUND TUMBLER
VASO REDONDO
9 CM - 3 IN^{9/16}

EMPILABLE
STACKABLE
APILABLE





REVISITER UNE ICÔNE

Créée en 1953, la théière Salam est le produit emblématique de la marque DEGRENNE. La finesse de la porcelaine alliée à l'éclat de la cloche sublime l'instant thé. Grâce à sa cloche tapissée d'une feutrine, **le thé conserve une température optimale deux fois plus longtemps que dans une théière classique.** Un procédé astucieux qui permet au thé de déployer toute la subtilité de ses saveurs au fil de la dégustation.

REVISIT AN ICON

Created in 1953, Salam teapot is the iconic product of DEGRENNE. The finesse of porcelain combined with the radiance of the outer body enhances the tea experience. With its inner lining of thin felt, **the tea inside is kept at its optimum temperature for twice as long as in a regular teapot.** This is a clever trick to ensure that the tea is infused with all the subtlety of its flavours as the tasting progresses.

VOLVER A EXPLORAR UN ICONO

Creada en 1953, la tetera Salam es el producto emblemático de la marca DEGRENNE. La finura de la porcelana combinada con el brillo del cuerpo de la tetera sublima el instante del té. Gracias a su cuerpo tapizado con fieltro, **el té conserva una temperatura óptima el doble de tiempo que una tetera clásica.** Este ingenioso proceso permite que el té despliegue toda la sutilidad de sus aromas a lo largo de la degustación.

SALAM BLANCHE - WHITE - BLANCO



211990 THÉIÈRE 8 TASSES
TEA POT 8 CUPS
TETERA 8 TAZAS
130 CL - 43 OZ^{15/16}

211989 THÉIÈRE 6 TASSES
TEA POT 6 CUPS
TETERA 6 TAZAS
100 CL - 33 OZ^{13/16}

211988 THÉIÈRE 4 TASSES
TEA POT 4 CUPS
TETERA 4 TAZAS
70 CL - 23 OZ^{11/16}

211987 THÉIÈRE 2 TASSES
TEA POT 2 CUPS
TETERA 2 TAZAS
35 CL - 11 OZ^{13/16}

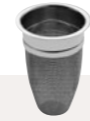

INFUSEUR
STAINLESS STEEL FILTER
FILTRO TETERA

147992
2 TASSES
2 CUPS - 2 TAZAS

147994
4 TASSES
4 CUPS - 4 TAZAS

147993
6/8 TASSES
6/8 CUPS
6/8 TAZAS

FEUTRE NOIR ISOLANT POUR THÉIÈRE
BLACK TEA POT FELT FILTER NEGRO AISLANTE TETERA

217130 - 2 TASSES
2 CUPS - 2 TAZAS

217131 - 4 TASSES
4 CUPS - 4 TAZAS

217132 - 6 TASSES
6 CUPS - 6 TAZAS

217133 - 8 TASSES
8 CUPS - 8 TAZAS



205135 BOUCHON PORCELAINE THÉIÈRE - 2/4 TASSES
PORCELAIN LID FOR TEA POT - 2/4 CUPS
TAPA DE PORCELANA TETERA - 2/4 TAZAS



205136 BOUCHON PORCELAINE THÉIÈRE - 6/8 TASSES
PORCELAIN LID FOR TEA POT - 6/8 CUPS
TAPA DE PORCELANA TETERA - 6/8 TAZAS



189949 CORPS THÉIÈRE 8 TASSES
TEA POT 8 CUPS WITHOUT LID
CUERPO TETERA 8 TAZAS

189948 CORPS THÉIÈRE 6 TASSES
TEA POT 6 CUPS WITHOUT LID
CUERPO TETERA 6 TAZAS

189947 CORPS THÉIÈRE 4 TASSES
TEA POT 4 CUPS WITHOUT LID
CUERPO TETERA 4 TAZAS

189946 CORPS THÉIÈRE 2 TASSES
TEA POT 2 CUPS WITHOUT LID
CUERPO TETERA 2 TAZAS

SALAM NOIRE - BLACK - NEGRO



211994 THÉIÈRE 8 TASSES
TEA POT 8 CUPS
TETERA 8 TAZAS
130 CL - 43 OZ^{15/16}

211993 THÉIÈRE 6 TASSES
TEA POT 6 CUPS
TETERA 6 TAZAS
100 CL - 33 OZ^{13/16}

216414 THÉIÈRE 6 TASSES
TEA POT 6 CUPS
TETERA 6 TAZAS
100 CL - 33 OZ^{13/16}

211992 THÉIÈRE 4 TASSES
TEA POT 4 CUPS
TETERA 4 TAZAS
70 CL - 23 OZ^{11/16}

216410 THÉIÈRE 4 TASSES
TEA POT 4 CUPS
TETERA 4 TAZAS
70 CL - 23 OZ^{11/16}

211991 THÉIÈRE 2 TASSES
TEA POT 2 CUPS
TETERA 2 TAZAS
35 CL - 11 OZ^{13/16}



210575 BOUCHON PORCELAINE THÉIÈRE - 2/4 TASSES
PORCELAIN LID FOR TEA POT - 2/4 CUPS
TAPA DE PORCELANA TETERA - 2/4 TAZAS



150447 CORPS THÉIÈRE 8 TASSES
TEA POT 8 CUPS WITHOUT LID
CUERPO TETERA 8 TAZAS

150456 CORPS THÉIÈRE 6 TASSES
TEA POT 6 CUPS WITHOUT LID
CUERPO TETERA 6 TAZAS



150455 CORPS THÉIÈRE 4 TASSES
TEA POT 4 CUPS WITHOUT LID
CUERPO TETERA 4 TAZAS



150450 CORPS THÉIÈRE 2 TASSES
TEA POT 2 CUPS WITHOUT LID
CUERPO TETERA 2 TAZAS



210576 BOUCHON PORCELAINE THÉIÈRE - 6/8 TASSES
PORCELAIN LID FOR TEA POT - 6/8 CUPS
TAPA DE PORCELANA TETERA - 6/8 TAZAS

SALAM COLOR

CLOCHE ALUMINIUM ZINC
ZINC ALUMINIUM LID
CAMPANA ZINC ALUMINIO



216416 THÉIÈRE 6 TASSES
TEA POT 6 CUPS
TETERA 6 TAZAS
100 CL - 33 OZ^{13/16}

216412 THÉIÈRE 4 TASSES
TEA POT 4 CUPS
TETERA 4 TAZAS
70 CL - 23 OZ^{11/16}

CLOCHE ALUMINIUM BRONZE
BRONZE ALUMINIUM LID
CAMPANA BRONCE ALUMINIO



216415 THÉIÈRE 6 TASSES
TEA POT 6 CUPS
TETERA 6 TAZAS
100 CL - 33 OZ^{13/16}

216411 THÉIÈRE 4 TASSES
TEA POT 4 CUPS
TETERA 4 TAZAS
70 CL - 23 OZ^{11/16}

CLOCHE ALUMINIUM BLEUE
BLUE ALUMINIUM LID
CAMPANA AZUL ALUMINIO



225359 THÉIÈRE 6 TASSES
TEA POT 6 CUPS
TETERA 6 TAZAS
100 CL - 33 OZ^{13/16}

225358 THÉIÈRE 4 TASSES
TEA POT 4 CUPS
TETERA 4 TAZAS
70 CL - 23 OZ^{11/16}

CLOCHE ALUMINIUM DORÉE
GOLD ALUMINIUM LID
CAMPANA DORADO ALUMINIO



234217 THÉIÈRE 6 TASSES
TEA POT 6 CUPS
TETERA 6 TAZAS
100 CL - 33 OZ^{13/16}

234216 THÉIÈRE 4 TASSES
TEA POT 4 CUPS
TETERA 4 TAZAS
70 CL - 23 OZ^{11/16}



BLANC - WHITE - BLANCO



210946
TASSE À CAFÉ
DEMITASSE CUP
TAZA DE CAFÉ
11 CL - 3 OZ^{3/4}



210947
TASSE À THÉ
COFFÉE/TEA CUP
TAZA DE TÉ
25 CL - 8 OZ^{7/16}



210948
TASSE DÉJEUNER
BREAKFAST CUP
TAZA DESAYUNO
42 CL - 14 OZ^{3/16}



210949
MUG À THÉ
TEA MUG
MUG
38 CL - 12 OZ^{7/8}



210950
SOUCOUBE CAFÉ/THÉ
DEMITASSE/COFFÉE/TEA SAUCER
PLATO CAFÉ/TÉ
16 CM - 6 IN^{5/16}

GRIS PERLE - LIGHT GREY - GRIS PERLA



230145
TASSE À CAFÉ
DEMITASSE CUP
TAZA DE CAFÉ
11 CL - 3 OZ^{3/4}



230146
TASSE À THÉ
COFFÉE/TEA CUP
TAZA DE TÉ
25 CL - 8 OZ^{7/16}



230147
TASSE DÉJEUNER
BREAKFAST CUP
TAZA DESAYUNO
42 CL - 14 OZ^{3/16}



230148
MUG À THÉ
TEA MUG
MUG
38 CL - 12 OZ^{7/8}



210951
SOUCOUBE DÉJEUNER/MUG
BREAKFAST/MUG SAUCER
PLATO DESAYUNO/MUG
18 CM - 7 IN^{7/16}

ROSE POUDRÉ - POWDER PINK - POLVO ROSA



230130
TASSE À CAFÉ
DEMITASSE CUP
TAZA DE CAFÉ
11 CL - 3 OZ^{3/4}



230131
TASSE À THÉ
COFFÉE/TEA CUP
TAZA DE TÉ
25 CL - 8 OZ^{7/16}



230132
TASSE DÉJEUNER
BREAKFAST CUP
TAZA DESAYUNO
42 CL - 14 OZ^{3/16}



230133
MUG À THÉ
TEA MUG
MUG
38 CL - 12 OZ^{7/8}



187276
SUCRIER
SUGAR BOWL
AZUCARERO CON TAPA
28 CL - 9 OZ^{7/16}



150475
SUCRIER
SUGAR BOWL
AZUCARERO CON TAPA
28 CL - 9 OZ^{7/16}



187283
CORPS SUCRIER
SUGAR BOWL WITHOUT LID
AZUCARERO



150469
CORPS SUCRIER
SUGAR BOWL WITHOUT LID
AZUCARERO



187277
CRÉMIER
CREAMER, JUG
LECHERA
15 CL - 5OZ^{1/16}



150485
CRÉMIER
CREAMER, JUG
LECHERA
15 CL - 5OZ^{1/16}



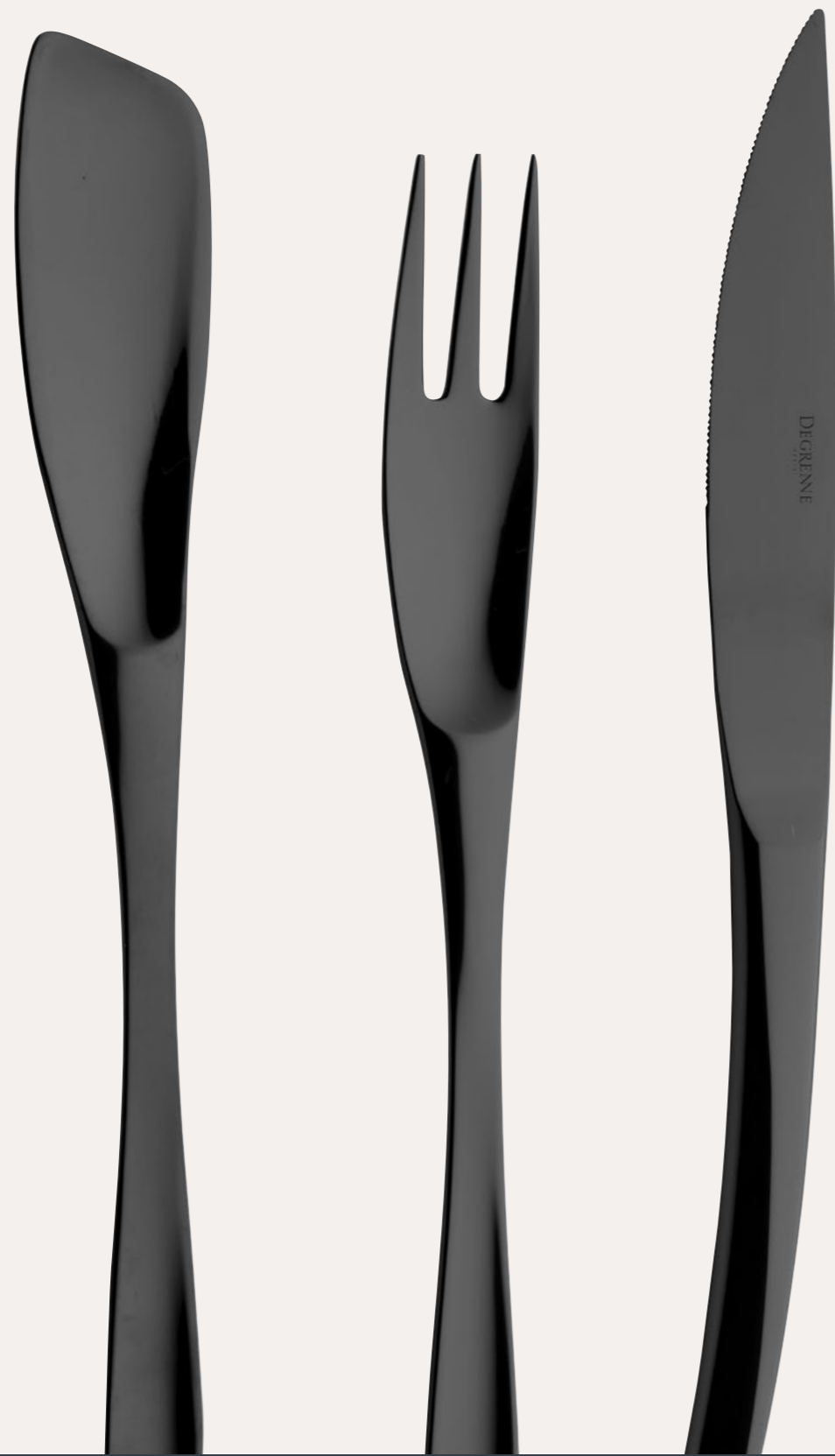

COUVERTS

Les ateliers DEGRENNE donnent forme aux majestueuses bobines d'acier inoxydable et transforment la matière brute en couverts. Les couverts DEGRENNE bénéficient d'un **savoir-faire unique** et se caractérisent par une **ergonomie et une résistance exceptionnelle**. Faciles d'entretien, ils répondent aux critères les plus exigeants de **qualité, de fonctionnalité et d'esthétique** : la qualité du design et le soin apporté aux finitions font de chacun de nos couverts de **véritables pièces d'orfèvre de style classique ou contemporain**. Créé en collaboration avec des chefs ou en laissant libre cours à l'imagination de nos designers, aux lignes sobres ou plus élaborées, **chaque modèle DEGRENNE trouve sa place à table**.

FLATWARE

DEGRENNE'S workshops shape the impressive reels of stainless steel and transform the raw material into cutlery. We use our **unique expertise** to create our cutlery, which is characterized by being extraordinarily **easy to use and sturdy**. DEGRENNE cutlery is easy to look after and meets the most stringent **quality, functionality and appearance criteria**. The design quality and painstaking finishes make each of our items of cutlery **true pieces of classic or contemporary silverware**. DEGRENNE cutlery is designed in partnership with chefs or by giving our designers free rein. Some items have simple lines, while others are more elaborate, but **every DEGRENNE design takes pride of place on a table**.

CUBIERTOS

Los talleres DEGRENNE dan forma a las majestuosas bobinas de acero inoxidable y transforman la materia bruta en cubiertos. Los cubiertos DEGRENNE se benefician de un **saber hacer único** y se caracterizan por una **ergonomía y una resistencia excepcional**. Fáciles de mantener, responden a los criterios más exigentes de **calidad, de funcionalidad y de estética** : La calidad del diseño y el cuidado aportado a los acabados hacen que cada uno de nuestros cubiertos sea una **verdadera pieza de orfebrería de estilo clásico o contemporáneo**. Creado en colaboración con chefs o dando rienda suelta a la imaginación de nuestros diseñadores, con líneas sobrias o más elaboradas, **cada modelo DEGRENNE encuentra su lugar en la mesa**.

XY BLACK MIROIR
205572 - SPATULE GOURMET
GOURMET SPATULA - ESPÁTULA GOURMET
205571 - FOURCHETTE POISSON - FISH FORK - TENEDOR PESCADO
195028 - COUTEAU DE TABLE MONOBLOC LAME SCIE - TABLE KNIFE SOLID
HANDLE SERRATED - CUCHILLO DE MESA HOJA SIERRA

P.87





COLLECTIONS
DESIGN



205559
FOURCHETTE DE TABLE
TABLE FORK
TENEDOR DE MESA
21,3 CM - 8 IN^{3/8}



193776
COUPEAU DE TABLE MONOBLOC LAME SCIE
TABLE KNIFE SOLID HANDLE SERRATED
CUCHILLO DE MESA HOJA SIERRA
23,3 CM - 9 IN^{5/16}



205560
CUILLÈRE DE TABLE
TABLE/PASTA SPOON
CUCHARA DE MESA
20,5 CM - 8 IN^{1/16}



205561
CUILLÈRE À SOUPE ANGLAISE
BOUILLON SPOON, ROUND
CUCHARA DE CONSOMÉ
18,5 CM - 7 IN^{5/16}



205567
CUILLÈRE GOURMANDE
DESSERT /SOUP SPOON, OVAL
CUCHARA DE POSTRE
18,6 CM - 7 IN^{5/16}



205566
FOURCHETTE GOURMANDE
DESSERT /SALAD FORK
TENEDOR DE POSTRE
18,6 CM - 7 IN^{5/16}



181111
COUPEAU À DESSERT MONOBLOC LAME UNIE
DESSERT KNIFE SOLID HANDLE
CUCHILLO DE POSTRE HOJA LISA
20,6 CM - 8 IN^{1/8}



181112
TARTINEUR
BUTTER SPREADER
ESPATULÍN PARA MANTEQUILLA
16 CM - 6 IN^{5/16}



205563
FOURCHETTE À POISSON
FISH FORK
TENEDOR DE PESCADO
20 CM - 7 IN^{7/8}



205564
SPATULE GOURMET
GOURMET SPATULA
ESPÁTULA GOURMET
20,2 CM - 7 IN^{5/16}



205565
FOURCHETTE GOURMET
GOURMET FORK
TENEDOR GOURMET
20 CM - 7 IN^{7/8}



205562
CUILLÈRE À CAFÉ
COFFEE/TEA SPOON
CUCHARA DE CAFÉ
14,3 CM - 5 IN^{5/8}



181109
CUILLÈRE À MOKA
DEMI TASSE SPOON
CUCHARA DE MOKA
11 CM - 4 IN^{5/16}



190018
CUILLÈRE À SODA
ICED TEA SPOON
CUCHARA DE SODA/HELADO
19 CM - 7 IN^{1/2}



181119
FOURCHETTE MISE EN BOUCHE
COCKTAIL FORK
TENEDOR PARA APERITIVO
15,5 CM - 6 IN^{1/8}



181120
SPATULE MISE EN BOUCHE
COCKTAIL SPATULA
ESPÁTULA PARA APERITIVO
15,5 CM - 6 IN^{1/8}



181121
CUILLÈRE MISE EN BOUCHE
COCKTAIL SPOON
CUCHARA PARA APERITIVO
11,6 CM - 4 IN^{9/16}

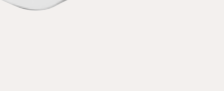

190424
FOURCHETTE À HUÎTRES
OYSTER FORK
TENEDOR DE OSTRAS
14,5 CM - 5 IN^{11/16}



181114
FOURCHETTE DE SERVICE
SERVING FORK
TENEDOR DE SERVICIO/ENSALADA
26 CM - 10 IN^{1/4}



181113
CUILLÈRE DE SERVICE
SERVING SPOON
CUCHARA DE SERVICIO/ENSALADA
26 CM - 10 IN^{1/4}



181122
SPATULE DE SERVICE
SERVING SPATULA
ESPÁTULA DE SERVICIO/ENSALADA
25 CM - 9 IN^{13/16}

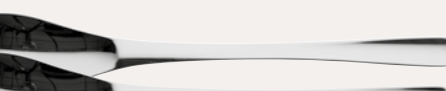

189999
SERVICE À SALADE
SALAD SERVING SET
SET SERVICIO DE ENSALADA
30 CM - 11 IN^{13/16}



153193
LOUCHE
SOUP LADLE
CAZO
29,7 CM - 11 IN^{11/16}



154606
LOUCHE À SAUCE
SAUCE LADLE
CUCHARA SALSA
18,5 CM - 7 IN^{5/16}



©Patrick ROUGEREAU

XY BLACK MIROIR

- | | | | |
|---|--|--|---|
|  | 205568
FOURCHETTE DE TABLE
TABLE FORK
TENEDOR DE MESA
21,3 CM - 8 IN ^{3/8} |  | 195034
CUILLÈRE À MOKA
DEMI TASSE SPOON
CUCHARA DE MOKA
11 CM - 4 IN ^{5/16} |
|  | 195028
COUTEAU DE TABLE
MONOBLOC LAME SCIE
TABLE KNIFE SOLID HANDLE SERRATED
CUCHILLO DE MESA HOJA SIERRA
23,3 CM - 9 IN ^{3/16} |  | 196674
CUILLÈRE À SODA
ICED TEA SPOON
CUCHARA DE SODA/HELADO
19 CM - 7 IN ^{1/2} |
|  | 205569
CUILLÈRE DE TABLE
TABLE/PASTA SPOON
CUCHARA DE MESA
20,5 CM - 8 IN ^{1/16} |  | 195039
FOURCHETTE MISE EN BOUCHE
COCKTAIL FORK
TENEDOR PARA APERITIVO
15,5 CM - 6 IN ^{1/8} |
|  | 200483
CUILLÈRE À SOUPE ANGLAISE
BOUILLON SPOON, ROUND
CUCHARA DE CONSOMÉ
18,5 CM - 7 IN ^{5/16} |  | 195042
SPATULE MISE EN BOUCHE
COCKTAIL SPATULA
ESPÁTULA PARA APERITIVO
15,5 CM - 6 IN ^{1/8} |
|  | 205575
CUILLÈRE GOURMANDE
DESSERT /SOUP SPOON, OVAL
CUCHARA DE POSTRE
18,6 CM - 7 IN ^{5/16} |  | 195041
CUILLÈRE MISE EN BOUCHE
COCKTAIL SPOON
CUCHARA PARA APERITIVO
11,6 CM - 4 IN ^{9/16} |
|  | 205574
FOURCHETTE GOURMANDE
DESSERT /SALAD FORK
TENEDOR DE POSTRE
18,6 CM - 7 IN ^{5/16} |  | 196014
FOURCHETTE À HUÎTRES
OYSTER FORK
TENEDOR DE OSTRAS
14,1 CM - 5 IN ^{9/16} |
|  | 195031
COUTEAU À DESSERT
MONOBLOC LAME UNIE
DESSERT KNIFE SOLID HANDLE
CUCHILLO DE POSTRE HOJA LISA
20,6 CM - 8 IN ^{1/8} |  | 199773
FOURCHETTE DE SERVICE
SERVING FORK
TENEDOR DE SERVICIO/ENSALADA
26 CM - 10 IN ^{1/4} |
|  | 195036
TARTINEUR
BUTTER SPREADER
ESPATULÍN PARA MANTEQUILLA
16 CM - 6 IN ^{5/16} |  | 199774
CUILLÈRE DE SERVICE
SERVING SPOON
CUCHARA DE SERVICIO/ENSALADA
26 CM - 10 IN ^{1/4} |
|  | 205571
FOURCHETTE À POISSON
FISH FORK
TENEDOR DE PESCADO
20 CM - 7 IN ^{7/8} |  | 199769
SPATULE DE SERVICE
SERVING SPATULA
ESPÁTULA DE SERVICIO/ENSALADA
25 CM - 9 IN ^{13/16} |
|  | 205572
SPATULE GOURMET
GOURMET SPATULA
ESPÁTULA GOURMET
20,2 CM - 7 IN ^{15/16} |  | 199771
SERVICE À SALADE
SALAD SERVING SET
SET SERVICIO DE ENSALADA
30 CM - 11 IN ^{13/16} |
|  | 205573
FOURCHETTE GOURMET
GOURMET FORK
TENEDOR GOURMET
20 CM - 7 IN ^{7/8} | | |
|  | 205570
CUILLÈRE À CAFÉ
COFFEE/TEA SPOON
CUCHARA DE CAFÉ
14,3 CM - 5 IN ^{5/8} | | |



LES COUVERTS
PLATWARE - CUBIERTOS

SERENITY

LES COUVERTS
FLATWARE - CUBIERTOS



143770
FOURCHETTE DE TABLE
TABLE FORK
TENEDOR DE MESA
20,9 CM - 8 IN^{3/16}

159484
COUTEAU DE TABLE MONOBLOC LAME SCIE
TABLE KNIFE SOLID HANDLE SERRATED
CUCHILLO DE MESA HOJA SIERRA
23,2 CM - 9 IN^{1/8}

208624
COUTEAU DE TABLE MONOBLOC LAME SCIE
TABLE KNIFE SOLID HANDLE SERRATED
CUCHILLO DE MESA HOJA SIERRA
23 CM - 9 IN^{7/16}

159451
COUTEAU À STEAK MONOBLOC LAME SCIE
STEAK KNIFE SOLID HANDLE SERRATED
CUCHILLO DE STEAK HOJA SIERRA
23,5 CM - 9 IN^{1/4}

143767
CUILLÈRE DE TABLE
TABLE/ PASTA SPOON
CUCHARA DE MESA
21,2 CM - 8 IN^{3/8}

148852
CUILLÈRE À SOUPE ANGLAISE
BOUILLON SPOON, ROUND
CUCHARA DE CONSOMÉ
17,1 CM - 6 IN^{3/4}

143801
CUILLÈRE À DESSERT
DESSERT/SOUP SPOON, OVAL
CUCHARA DE POSTRE
18,7 CM - 7 IN^{3/8}

143804
FOURCHETTE À DESSERT
DESSERT/SALAD FORK
TENEDOR DE POSTRE
18,4 CM - 7 IN^{1/4}

159492
COUTEAU À DESSERT MONOBLOC LAME UNIE
DESSERT KNIFE SOLID HANDLE
CUCHILLO DE POSTRE HOJA LISA
20,4 CM - 8 IN^{1/16}

208625
COUTEAU À DESSERT MONOBLOC LAME SCIE
DESSERT KNIFE SOLID HANDLE
SERRATED
CUCHILLO DE POSTRE
HOJA SIERRA
20,7 CM - 8 IN^{1/8}

181112
TARTINEUR
BUTTER SPREADER
ESPATULIN PARA MANTEQUILLA
16 CM - 6 IN^{5/16}

143790
FOURCHETTE À POISSON
FISH FORK
TENEDOR DE PESCADO
18,5 CM - 7 IN^{1/16}



181467
COUTEAU À POISSON/ GOURMET
GOURMET/FISH KNIFE
CUCHILLO DE PESCADO
20,1 CM - 7 IN^{15/16}

143772
CUILLÈRE À CAFÉ
COFFEE/TEA SPOON
CUCHARA DE CAFÉ
14,9 CM - 5 IN^{7/8}

148855
CUILLÈRE À MOKA
DEMI TASSE SPOON
CUCHARA DE MOKA
11 CM - 4 IN^{5/16}

190018
CUILLÈRE À SODA
ICED TEA SPOON
CUCHARA DE SODA/HELADO
19 CM - 7 IN^{1/2}

143782
FOURCHETTE À GÂTEAUX/ COCKTAIL
PASTRY/COCKTAIL FORK
TENEDOR DE PASTEL
14,9 CM - 5 IN^{7/8}

190424
FOURCHETTE À HÛÎTRES
OYSTER FORK
TENEDOR DE OSTRAS
14,1 CM - 5 IN^{9/16}

197522
FOURCHETTE DE SERVICE
SERVING FORK
TENEDOR DE SERVICIO/ENSALADA
26,6 CM - 10 IN^{1/2}

197523
CUILLÈRE DE SERVICE
SERVING SPOON
CUCHARA DE SERVICIO/ENSALADA
27 CM - 10 IN^{5/8}

197525
SERVICE À SALADE
SALAD SERVING SET
SET SERVICIO DE ENSALADA
30 CM - 11 IN^{13/16}







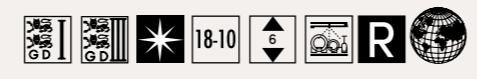















197527
PELLE À TARTE MONOBLOC
PASTRY SERVER SOLID HANDLE
PALA PARA TARTA
25,1 CM - 9 IN^{7/8}

153193
LOUCHE
SOUP LADLE
CAZO
29,7 CM - 11 IN^{11/16}

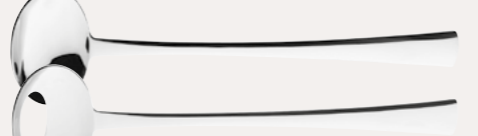
154606
CUILLÈRE À SAUCE
SAUCE LADLE
CUCHARA DE SALSA
18,5 CM - 7 IN^{1/16}



©Patrick ROUGEREAU

- | | | | |
|---|--|--|---|
|  | 205540
FOURCHETTE DE TABLE
TABLE FORK
TENEDOR DE MESA
20,9 CM - 8 IN ^{3/16} |  | 205545
COUTEAU À POISSON/
GOURMET
GOURMET/FISH KNIFE
CUCHILLO DE PESCADO
20,7 CM - 8 IN ^{7/8} |
|  | 159484
COUTEAU DE TABLE
MONOBLOC LAME SCIE
TABLE KNIFE SOLID HANDLE SERRATED
CUCHILLO DE MESA HOJA SIERRA
23,2 CM - 9 IN ^{1/8} |  | 205543
CUILLÈRE À CAFÉ
COFFEE/TEA SPOON
CUCHARA DE CAFÉ
14 CM - 5 IN ^{1/2} |
|  | 208624
COUTEAU DE TABLE
MONOBLOC LAME SCIE
TABLE KNIFE SOLID HANDLE SERRATED
CUCHILLO DE MESA HOJA SIERRA
23 CM - 9 IN ^{7/8} |  | 159512
CUILLÈRE À MOKA
DEMI TASSE SPOON
CUCHARA DE MOKA
11,1 CM - 4 IN ^{3/8} |
|  | 159451
COUTEAU À STEAK
MONOBLOC LAME SCIE
STEAK KNIFE SOLID HANDLE SERRATED
CUCHILLO DE STEAK HOJA SIERRA
23,5 CM - 9 IN ^{1/4} |  | 190018
CUILLÈRE À SODA
ICED TEA SPOON
CUCHARA DE SODA/HELADO
19 CM - 7 IN ^{1/2} |
|  | 205541
CUILLÈRE DE TABLE
TABLE/PASTA SPOON
CUCHARA DE MESA
20,9 CM - 8 IN ^{1/4} |  | 205548
FOURCHETTE À GÂTEAUX/
COCKTAIL
PASTRY/COCKTAIL FORK
TENEDOR DE PASTEL
14,1 CM - 5 IN ^{9/16} |
|  | 205542
CUILLÈRE À SOUPE ANGLAISE
BOUILLON SPOON, ROUND
CUCHARA DE CONSOMÉ
17,8 CM - 7 IN |  | 190424
FOURCHETTE À HÙITRES
OYSTER FORK
TENEDOR DE OSTRAS
14,5 CM - 5 IN ^{17/16} |
|  | 205547
CUILLÈRE À DESSERT
DESSERT/SOUP SPOON, OVAL
CUCHARA DE POSTRE
18,4 CM - 7 IN ^{1/4} |  | 159501
FOURCHETTE DE SERVICE
SERVING FORK
TENEDOR DE SERVICIO/ENSALADA
26 CM - 10 IN ^{1/4} |
|  | 205546
FOURCHETTE À DESSERT
DESSERT/SALAD FORK
TENEDOR DE POSTRE
18,4 CM - 7 IN ^{1/4} |  | 159500
CUILLÈRE DE SERVICE
SERVING SPOON
CUCHARA DE SERVICIO/ENSALADA
26 CM - 10 IN ^{1/4} |
|  | 159492
COUTEAU À DESSERT
MONOBLOC LAME UNIE
DESSERT KNIFE SOLID HANDLE
CUCHILLO DE POSTRE HOJA LISA
20,4 CM - 8 IN ^{1/8} |  | 159504
SERVICE À SALADE
SALAD SERVING SET
SET SERVICIO DE ENSALADA
30 CM - 11 IN ^{13/16} |
|  | 208625
COUTEAU À DESSERT
MONOBLOC LAME SCIE
DESSERT KNIFE SOLID HANDLE
SERRATED
CUCHILLO DE POSTRE
HOJA SIERRA
20,7 CM - 8 IN ^{1/8} |  | 159490
PELLE À TARTE
MONOBLOC
PASTRY SERVER SOLID HANDLE
PALA PARA TARTA
26,2 CM - 10 IN ^{1/4} |
|  | 154612
COUTEAU À BEURRE
MONOBLOC LAME UNIE
BUTTER KNIFE SOLID HANDLE
CUCHILLO DE MANTEQUILLA HOJA LISA
19,4 CM - 7 IN ^{5/8} |  | 153193
LOUCHE
SOUP LADLE
CAZO
29,7 CM - 11 IN ^{11/16} |
|  | 205544
FOURCHETTE À POISSON
FISH FORK
TENEDOR DE PESCADO
18,4 CM - 7 IN ^{1/4} |  | 154606
CUILLÈRE À SAUCE
SAUCE LADLE
CUCHARA DE SALSA
18,5 CM - 7 IN ^{37/64} |

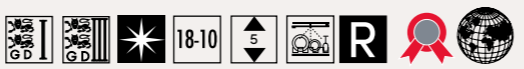



233011
FOURCHETTE DE TABLE
TABLE FORK
TENEDOR DE MESA
20,5 CM - 8 IN^{7/8}



233013
COUTEAU DE TABLE MONOBLOC À BOUT POINTU LAME SCIE
TABLE KNIFE SOLID HANDLE POINTED BLADE SERRATED
CUCHILLO DE MESA HOJA SIERRA
23,3 CM - 9 IN^{3/8}



233014
COUTEAU DE TABLE MONOBLOC À BOUT ROND LAME SCIE
TABLE KNIFE SOLID HANDLE ROUNDED BLADE SERRATED
CUCHILLO DE MESA HOJA SIERRA
23,3 CM - 9 IN^{3/8}



229520
COUTEAU DE TABLE MONOCOQUE MANCHE ORFÈVRE LAME UNIE
TABLE KNIFE HOLLOW HANDLE
CUCHILLO DE MESA ENMANGADO HOJA LISA
23,3 CM - 9 IN^{3/8}



233012
CUILLÈRE DE TABLE
TABLE/ PASTA SPOON
CUCHARA DE MESA
20,5 CM - 8 IN^{7/8}



233022
CUILLÈRE À SOUPE ANGLAISE
BOUILLON SPOON, ROUND
CUCHARA DE CONSOMÉ
18,5 CM - 7 IN^{5/8}



233018
CUILLÈRE À DESSERT
DESSERT/SOUP SPOON
CUCHARA DE POSTRE
18,5 CM - 7 IN^{5/8}



233017
FOURCHETTE À DESSERT
DESSERT/SALAD FORK
TENEDOR DE POSTRE
18,5 CM - 7 IN^{5/8}



233019
COUTEAU À DESSERT MONOBLOC À BOUT ROND LAME UNIE
DESSERT KNIFE SOLID HANDLE ROUNDED BLADE
CUCHILLO DE POSTRE HOJA LISA
20,9 CM - 8 IN^{1/4}



233023
COUTEAU À BEURRE MONOBLOC LAME UNIE
BUTTER KNIFE SOLID HANDLE
CUCHILLO DE MANTEQUILLA HOJA LISA
17,5 CM - 6 IN^{7/8}



233021
CUILLÈRE GOURMET
GOURMET SPOON
CUCHARA PARA SALSA
18,5 CM - 7 IN^{5/8}



233015
CUILLÈRE À CAFÉ
COFFEE/TEA SPOON
CUCHARA DE CAFÉ
13,9 CM - 5 IN^{1/2}



233016
CUILLÈRE À MOKA
DEMI TASSE SPOON
CUCHARA DE MOKA
11,7 CM - 4 IN^{5/8}



233020
FOURCHETTE À GÂTEAUX/ COCKTAIL
PASTRY/COCKTAIL FORK
TENEDOR DE PASTEL
13,9 CM - 5 IN^{1/2}



233024
FOURCHETTE DE SERVICE
SERVING FORK
TENEDOR DE SERVICIO/ENSALADA
26,3 CM - 10 IN^{3/8}



233025
CUILLÈRE DE SERVICE
SERVING SPOON
CUCHARA DE SERVICIO/ENSALADA
26,3 CM - 10 IN^{3/8}

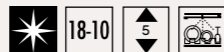

L'ABUS D'ALCOOL EST DANGEREUX POUR LA SANTÉ
DEGRENNÉ PROMOTES RESPONSIBLE DRINKING AND DISCOURAGES ALCOHOL MISUSE
EL ABUSO DE ALCOHOL ES PELIGROSO PARA LA SALUD



LES COUVERTS
FLATWARE - CUBIERTOS

























GUEST MIROIR

LES COUVERTS
PLATWARE - CUBIERTOS



DEGRENE



- | | |
|---|---|
| 
197507
FOURCHETTE DE TABLE
TABLE FORK
TENEDOR DE MESA
21,3 CM - 8 IN ^{3/8} | 
197515
COUPEAU À POISSON/
GOURMET
GOURMET/FISH KNIFE
CUCHILLO DE PESCADO
21,3 CM - 8 IN ^{3/8} |
| 
197509
COUPEAU DE TABLE
MONOBLOC LAME SCIE
TABLE KNIFE SOLID HANDLE SERRATED
CUCHILLO DE MESA HOJA SIERRA
23,2 CM - 9 IN ^{1/8} | 
197508
CUILLÈRE À CAFÉ
COFFEE/TEA SPOON
CUCHARA DE CAFÉ
14,3 CM - 5 IN ^{5/8} |
| <p>NEW</p> 
235481
COUPEAU DE TABLE
MONOBLOC LAME SCIE
TABLE KNIFE SOLID HANDLE SERRATED
CUCHILLO DE MESA HOJA SIERRA
23,7 CM - 9 IN ^{5/16} | 
197510
CUILLÈRE À MOKA
DEMI TASSE SPOON
CUCHARA DE MOKA
11,7 CM - 4 IN ^{5/8} |
| 
197521
COUPEAU À STEAK
MONOBLOC LAME SCIE
STEAK KNIFE SOLID HANDLE SERRATED
CUCHILLO DE STEAK HOJA SIERRA
23,2 CM - 9 IN ^{1/8} | 
190018
CUILLÈRE À SODA
ICED TEA SPOON
CUCHARA DE SODA/HELADO
19 CM - 7 IN ^{1/2} |
| 
197506
CUILLÈRE DE TABLE
TABLE/ PASTA SPOON
CUCHARA DE MESA
21,6 CM - 8 IN ^{1/2} | 
197516
FOURCHETTE À GÂTEAUX/
COCKTAIL
PASTRY/COCKTAIL FORK
TENEDOR DE PASTEL
13,9 CM - 5 IN ^{1/2} |
| 
197518
CUILLÈRE À SOUPE ANGLAISE
BOUILLON SPOON, ROUND
CUCHARA DE CONSOMÉ
18,5 CM - 7 IN ^{5/16} | 
190424
FOURCHETTE À HUÎTRES
OYSTER FORK
TENEDOR DE OSTRAS
14,1 CM - 5 IN ^{5/16} |
| 
197512
CUILLÈRE À DESSERT
DESSERT/SOUP SPOON, OVAL
CUCHARA DE POSTRE
19,5 CM - 7 IN ^{11/16} | 
197522
FOURCHETTE DE SERVICE
SERVING FORK
TENEDOR DE SERVICIO/ENSALADA
26,6 CM - 10 IN ^{1/2} |
| 
197511
FOURCHETTE À DESSERT
DESSERT/SALAD FORK
TENEDOR DE POSTRE
19,2 CM - 7 IN ^{3/16} | 
197523
CUILLÈRE DE SERVICE
SERVING SPOON
CUCHARA DE SERVICIO/ENSALADA
27 CM - 10 IN ^{5/8} |
| 
210629
COUPEAU À DESSERT
MONOBLOC LAME SCIE
DESSERT KNIFE SOLID HANDLE
SERRATED
CUCHILLO DE POSTRE HOJA SIERRA
20,9 CM - 8 IN ^{3/16} | 
197525
SERVICE À SALADE
SALAD SERVING SET
SET SERVICIO DE ENSALADA
30 CM - 11 IN ^{13/16} |
| <p>NEW</p> 
235482
COUPEAU DE TABLE
MONOBLOC LAME SCIE
TABLE KNIFE SOLID HANDLE SERRATED
CUCHILLO DE MESA HOJA SIERRA
21,3 CM - 8 IN ^{3/8} | 
197527
PELLE À TARTE
MONOBLOC
PASTRY SERVER SOLID HANDLE
PALA PARA TARTA
25,1 CM - 9 IN ^{7/8} |
| 
197520
COUPEAU À BEURRE
MONOBLOC LAME UNIE
BUTTER KNIFE SOLID HANDLE
CUCHILLO PARA MANTEQUILLA HOJA LISA
19,3 CM - 7 IN ^{5/8} | 
153193
LOUCHE
SOUP LADLE
CAZO
29,7 CM - 11 IN ^{11/16} |
| 
197514
FOURCHETTE À POISSON
FISH FORK
TENEDOR DE PESCADO
19,2 CM - 7 IN ^{3/16} | 
154606
CUILLÈRE À SAUCE
SAUCE LADLE
CUCHARA DE SALSA
18,5 CM - 7 IN ^{3/8} |

LABUS D'ALCOOL EST DANGEREUX POUR LA SANTÉ
DEGRENE PROMOTES RESPONSIBLE DRINKING AND DISCOURAGES ALCOHOL MISUSE
EL ABUSO DE ALCOHOL ES PELIGROSO PARA LA SALUD









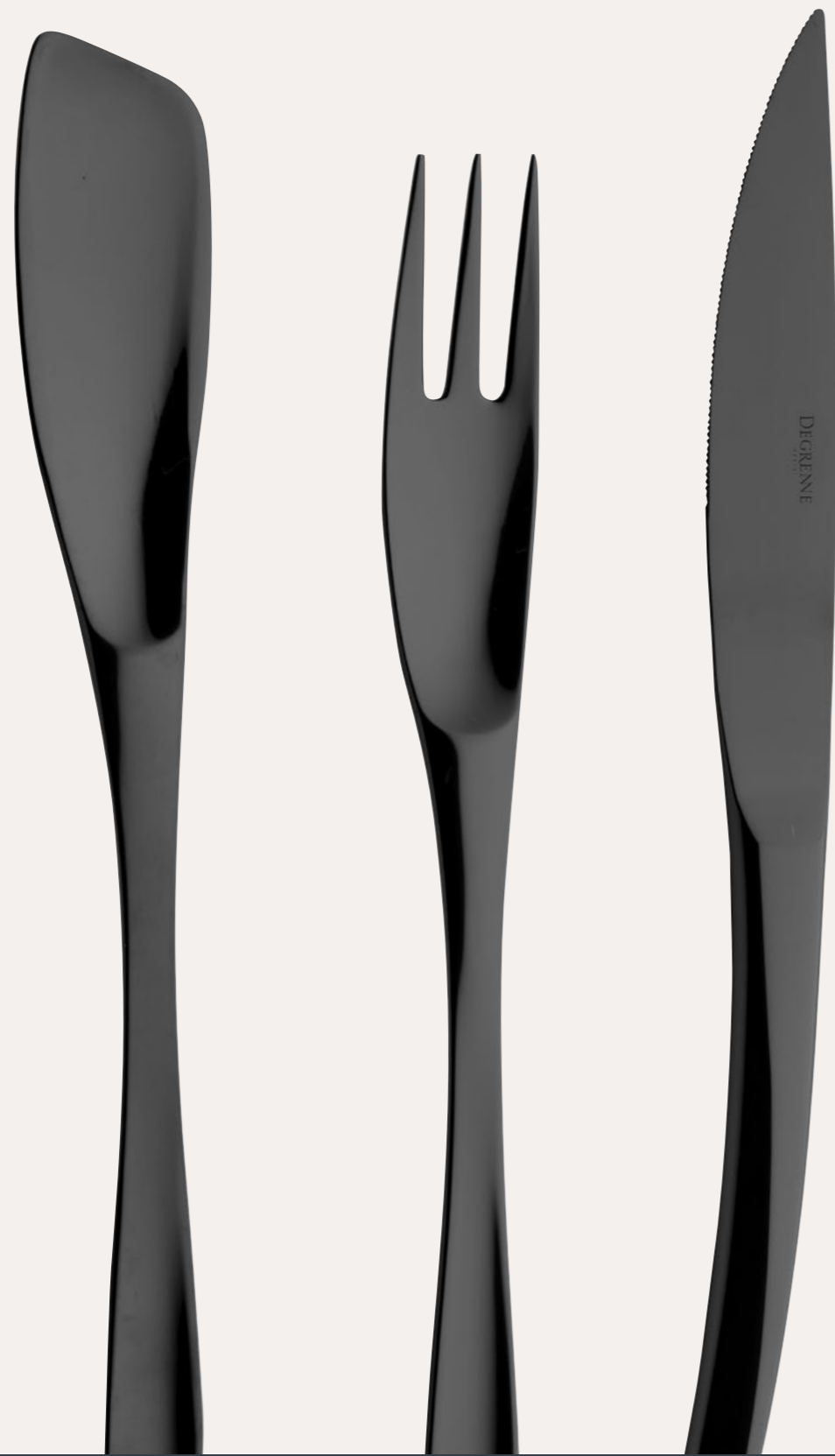

COUVERTS

Les ateliers DEGRENNE donnent forme aux majestueuses bobines d'acier inoxydable et transforment la matière brute en couverts. Les couverts DEGRENNE bénéficient d'un **savoir-faire unique** et se caractérisent par une **ergonomie et une résistance exceptionnelle**. Faciles d'entretien, ils répondent aux critères les plus exigeants de **qualité, de fonctionnalité et d'esthétique** : la qualité du design et le soin apporté aux finitions font de chacun de nos couverts de **véritables pièces d'orfèvre de style classique ou contemporain**. Créé en collaboration avec des chefs ou en laissant libre cours à l'imagination de nos designers, aux lignes sobres ou plus élaborées, **chaque modèle DEGRENNE trouve sa place à table**.

FLATWARE

DEGRENNE'S workshops shape the impressive reels of stainless steel and transform the raw material into cutlery. We use our **unique expertise** to create our cutlery, which is characterized by being extraordinarily **easy to use and sturdy**. DEGRENNE cutlery is easy to look after and meets the most stringent **quality, functionality and appearance criteria**. The design quality and painstaking finishes make each of our items of cutlery **true pieces of classic or contemporary silverware**. DEGRENNE cutlery is designed in partnership with chefs or by giving our designers free rein. Some items have simple lines, while others are more elaborate, but **every DEGRENNE design takes pride of place on a table**.

CUBIERTOS

Los talleres DEGRENNE dan forma a las majestuosas bobinas de acero inoxidable y transforman la materia bruta en cubiertos. Los cubiertos DEGRENNE se benefician de un **saber hacer único** y se caracterizan por una **ergonomía y una resistencia excepcional**. Fáciles de mantener, responden a los criterios más exigentes de **calidad, de funcionalidad y de estética** : La calidad del diseño y el cuidado aportado a los acabados hacen que cada uno de nuestros cubiertos sea una **verdadera pieza de orfebrería de estilo clásico o contemporáneo**. Creado en colaboración con chefs o dando rienda suelta a la imaginación de nuestros diseñadores, con líneas sobrias o más elaboradas, **cada modelo DEGRENNE encuentra su lugar en la mesa**.

XY BLACK MIROIR
205572 - SPATULE GOURMET
GOURMET SPATULA - ESPÁTULA GOURMET
205571 - FOURCHETTE POISSON - FISH FORK - TENEDOR PESCADO
195028 - COUTEAU DE TABLE MONOBLOC LAME SCIE - TABLE KNIFE SOLID
HANDLE SERRATED - CUCHILLO DE MESA HOJA SIERRA







P.87





COLLECTIONS
DESIGN



- | | | | |
|---|--|--|---|
|  | 205559
FOURCHETTE DE TABLE
TABLE FORK
TENEDOR DE MESA
21,3 CM - 8 IN ^{3/8} |  | 181109
CUILLÈRE À MOKA
DEMI TASSE SPOON
CUCHARA DE MOKA
11 CM - 4 IN ^{5/16} |
|  | 193776
COUTEAU DE TABLE
MONOBLOC LAME SCIE
TABLE KNIFE SOLID HANDLE SERRATED
CUCHILLO DE MESA HOJA SIERRA
23,3 CM - 9 IN ^{5/16} |  | 190018
CUILLÈRE À SODA
ICED TEA SPOON
CUCHARA DE SODA/HELADO
19 CM - 7 IN ^{1/2} |
|  | 205560
CUILLÈRE DE TABLE
TABLE/PASTA SPOON
CUCHARA DE MESA
20,5 CM - 8 IN ^{1/16} |  | 181119
FOURCHETTE MISE EN BOUCHE
COCKTAIL FORK
TENEDOR PARA APERITIVO
15,5 CM - 6 IN ^{1/8} |
|  | 205561
CUILLÈRE À SOUPE ANGLAISE
BOUILLON SPOON, ROUND
CUCHARA DE CONSOMÉ
18,5 CM - 7 IN ^{5/16} |  | 181120
SPATULE MISE EN BOUCHE
COCKTAIL SPATULA
ESPÁTULA PARA APERITIVO
15,5 CM - 6 IN ^{1/8} |
|  | 205567
CUILLÈRE GOURMANDE
DESSERT /SOUP SPOON, OVAL
CUCHARA DE POSTRE
18,6 CM - 7 IN ^{5/16} |  | 181121
CUILLÈRE MISE EN BOUCHE
COCKTAIL SPOON
CUCHARA PARA APERITIVO
11,6 CM - 4 IN ^{9/16} |
|  | 205566
FOURCHETTE GOURMANDE
DESSERT /SALAD FORK
TENEDOR DE POSTRE
18,6 CM - 7 IN ^{5/16} |  | 190424
FOURCHETTE À HUÎTRES
OYSTER FORK
TENEDOR DE OSTRAS
14,5 CM - 5 IN ^{11/16} |
|  | 181111
COUTEAU À DESSERT
MONOBLOC LAME UNIE
DESSERT KNIFE SOLID HANDLE
CUCHILLO DE POSTRE HOJA LISA
20,6 CM - 8 IN ^{1/8} |  | 181114
FOURCHETTE DE SERVICE
SERVING FORK
TENEDOR DE SERVICIO/ENSALADA
26 CM - 10 IN ^{1/4} |
|  | 181112
TARTINEUR
BUTTER SPREADER
ESPATULÍN PARA MANTEQUILLA
16 CM - 6 IN ^{5/16} |  | 181113
CUILLÈRE DE SERVICE
SERVING SPOON
CUCHARA DE SERVICIO/ENSALADA
26 CM - 10 IN ^{1/4} |
|  | 205563
FOURCHETTE À POISSON
FISH FORK
TENEDOR DE PESCADO
20 CM - 7 IN ^{7/8} |  | 181122
SPATULE DE SERVICE
SERVING SPATULA
ESPÁTULA DE SERVICIO/ENSALADA
25 CM - 9 IN ^{13/16} |
|  | 205564
SPATULE GOURMET
GOURMET SPATULA
ESPÁTULA GOURMET
20,2 CM - 7 IN ^{5/16} |  | 189999
SERVICE À SALADE
SALAD SERVING SET
SET SERVICIO DE ENSALADA
30 CM - 11 IN ^{13/16} |
|  | 205565
FOURCHETTE GOURMET
GOURMET FORK
TENEDOR GOURMET
20 CM - 7 IN ^{7/8} |  | 153193
LOUCHE
SOUP LADLE
CAZO
29,7 CM - 11 IN ^{11/16} |
|  | 205562
CUILLÈRE À CAFÉ
COFFEE/TEA SPOON
CUCHARA DE CAFÉ
14,3 CM - 5 IN ^{5/8} |  | 154606
LOUCHE À SAUCE
SAUCE LADLE
CUCHARA SALSA
18,5 CM - 7 IN ^{5/16} |



XY BLACK MIROIR

- | | | | |
|---|--|--|---|
|  | 205568
FOURCHETTE DE TABLE
TABLE FORK
TENEDOR DE MESA
21,3 CM - 8 IN ^{3/8} |  | 195034
CUILLÈRE À MOKA
DEMI TASSE SPOON
CUCHARA DE MOKA
11 CM - 4 IN ^{5/16} |
|  | 195028
COUTEAU DE TABLE
MONOBLOC LAME SCIE
TABLE KNIFE SOLID HANDLE SERRATED
CUCHILLO DE MESA HOJA SIERRA
23,3 CM - 9 IN ^{3/16} |  | 196674
CUILLÈRE À SODA
ICED TEA SPOON
CUCHARA DE SODA/HELADO
19 CM - 7 IN ^{1/2} |
|  | 205569
CUILLÈRE DE TABLE
TABLE/PASTA SPOON
CUCHARA DE MESA
20,5 CM - 8 IN ^{1/16} |  | 195039
FOURCHETTE MISE EN BOUCHE
COCKTAIL FORK
TENEDOR PARA APERITIVO
15,5 CM - 6 IN ^{1/8} |
|  | 200483
CUILLÈRE À SOUPE ANGLAISE
BOUILLON SPOON, ROUND
CUCHARA DE CONSOMÉ
18,5 CM - 7 IN ^{5/16} |  | 195042
SPATULE MISE EN BOUCHE
COCKTAIL SPATULA
ESPÁTULA PARA APERITIVO
15,5 CM - 6 IN ^{1/8} |
|  | 205575
CUILLÈRE GOURMANDE
DESSERT /SOUP SPOON, OVAL
CUCHARA DE POSTRE
18,6 CM - 7 IN ^{5/16} |  | 195041
CUILLÈRE MISE EN BOUCHE
COCKTAIL SPOON
CUCHARA PARA APERITIVO
11,6 CM - 4 IN ^{9/16} |
|  | 205574
FOURCHETTE GOURMANDE
DESSERT /SALAD FORK
TENEDOR DE POSTRE
18,6 CM - 7 IN ^{5/16} |  | 196014
FOURCHETTE À HUÎTRES
OYSTER FORK
TENEDOR DE OSTRAS
14,1 CM - 5 IN ^{9/16} |
|  | 195031
COUTEAU À DESSERT
MONOBLOC LAME UNIE
DESSERT KNIFE SOLID HANDLE
CUCHILLO DE POSTRE HOJA LISA
20,6 CM - 8 IN ^{1/8} |  | 199773
FOURCHETTE DE SERVICE
SERVING FORK
TENEDOR DE SERVICIO/ENSALADA
26 CM - 10 IN ^{1/4} |
|  | 195036
TARTINEUR
BUTTER SPREADER
ESPATULÍN PARA MANTEQUILLA
16 CM - 6 IN ^{5/16} |  | 199774
CUILLÈRE DE SERVICE
SERVING SPOON
CUCHARA DE SERVICIO/ENSALADA
26 CM - 10 IN ^{1/4} |
|  | 205571
FOURCHETTE À POISSON
FISH FORK
TENEDOR DE PESCADO
20 CM - 7 IN ^{7/8} |  | 199769
SPATULE DE SERVICE
SERVING SPATULA
ESPÁTULA DE SERVICIO/ENSALADA
25 CM - 9 IN ^{13/16} |
|  | 205572
SPATULE GOURMET
GOURMET SPATULA
ESPÁTULA GOURMET
20,2 CM - 7 IN ^{15/16} |  | 199771
SERVICE À SALADE
SALAD SERVING SET
SET SERVICIO DE ENSALADA
30 CM - 11 IN ^{13/16} |
|  | 205573
FOURCHETTE GOURMET
GOURMET FORK
TENEDOR GOURMET
20 CM - 7 IN ^{7/8} | | |
|  | 205570
CUILLÈRE À CAFÉ
COFFEE/TEA SPOON
CUCHARA DE CAFÉ
14,3 CM - 5 IN ^{5/8} | | |



LES COUVERTS
PLATWARE - CUBIERTOS

SERENITY

LES COUVERTS
PLATWARE - CUBIERTOS



143770
FOURCHETTE DE TABLE
TABLE FORK
TENEDOR DE MESA
20,9 CM - 8 IN^{3/16}

159484
COUTEAU DE TABLE MONOBLOC LAME SCIE
TABLE KNIFE SOLID HANDLE SERRATED
CUCHILLO DE MESA HOJA SIERRA
23,2 CM - 9 IN^{1/8}

208624
COUTEAU DE TABLE MONOBLOC LAME SCIE
TABLE KNIFE SOLID HANDLE SERRATED
CUCHILLO DE MESA HOJA SIERRA
23 CM - 9 IN^{7/16}

159451
COUTEAU À STEAK MONOBLOC LAME SCIE
STEAK KNIFE SOLID HANDLE SERRATED
CUCHILLO DE STEAK HOJA SIERRA
23,5 CM - 9 IN^{1/4}

143767
CUILLÈRE DE TABLE
TABLE/ PASTA SPOON
CUCHARA DE MESA
21,2 CM - 8 IN^{3/8}

148852
CUILLÈRE À SOUPE ANGLAISE
BOUILLON SPOON, ROUND
CUCHARA DE CONSOMÉ
17,1 CM - 6 IN^{3/4}

143801
CUILLÈRE À DESSERT
DESSERT/SOUP SPOON, OVAL
CUCHARA DE POSTRE
18,7 CM - 7 IN^{3/8}

143804
FOURCHETTE À DESSERT
DESSERT/SALAD FORK
TENEDOR DE POSTRE
18,4 CM - 7 IN^{1/4}

159492
COUTEAU À DESSERT MONOBLOC LAME UNIE
DESSERT KNIFE SOLID HANDLE
CUCHILLO DE POSTRE HOJA LISA
20,4 CM - 8 IN^{1/16}

208625
COUTEAU À DESSERT MONOBLOC LAME SCIE
DESSERT KNIFE SOLID HANDLE SERRATED
CUCHILLO DE POSTRE HOJA SIERRA
20,7 CM - 8 IN^{1/8}

181112
TARTINEUR
BUTTER SPREADER
ESPATULIN PARA MANTEQUILLA
16 CM - 6 IN^{5/16}

143790
FOURCHETTE À POISSON
FISH FORK
TENEDOR DE PESCADO
18,5 CM - 7 IN^{1/16}



181467
COUTEAU À POISSON/ GOURMET
GOURMET/FISH KNIFE
CUCHILLO DE PESCADO
20,1 CM - 7 IN^{15/16}

143772
CUILLÈRE À CAFÉ
COFFEE/TEA SPOON
CUCHARA DE CAFÉ
14,9 CM - 5 IN^{7/8}

148855
CUILLÈRE À MOKA
DEMI TASSE SPOON
CUCHARA DE MOKA
11 CM - 4 IN^{5/16}

190018
CUILLÈRE À SODA
ICED TEA SPOON
CUCHARA DE SODA/HELADO
19 CM - 7 IN^{1/2}

143782
FOURCHETTE À GÂTEAUX/ COCKTAIL
PASTRY/COCKTAIL FORK
TENEDOR DE PASTEL
14,9 CM - 5 IN^{7/8}

190424
FOURCHETTE À HÛÎTRES
OYSTER FORK
TENEDOR DE OSTRAS
14,1 CM - 5 IN^{9/16}

197522
FOURCHETTE DE SERVICE
SERVING FORK
TENEDOR DE SERVICIO/ENSALADA
26,6 CM - 10 IN^{1/2}

197523
CUILLÈRE DE SERVICE
SERVING SPOON
CUCHARA DE SERVICIO/ENSALADA
27 CM - 10 IN^{5/8}

197525
SERVICE À SALADE
SALAD SERVING SET
SET SERVICIO DE ENSALADA
30 CM - 11 IN^{13/16}

197527
PELLE À TARTE MONOBLOC
PASTRY SERVER SOLID HANDLE
PALA PARA TARTA
25,1 CM - 9 IN^{7/8}

153193
LOUCHE
SOUP LADLE
CAZO
29,7 CM - 11 IN^{17/16}

154606
CUILLÈRE À SAUCE
SAUCE LADLE
CUCHARA DE SALSA
18,5 CM - 7 IN^{1/16}

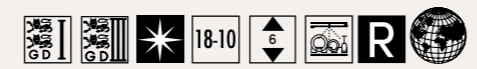

©Patrick ROUGEREAU



205540
FOURCHETTE DE TABLE
TABLE FORK
TENEDOR DE MESA
20,9 CM - 8 IN^{3/16}



159484
COUTEAU DE TABLE MONOBLOC LAME SCIE
TABLE KNIFE SOLID HANDLE SERRATED
CUCHILLO DE MESA HOJA SIERRA
23,2 CM - 9 IN^{1/8}



208624
COUTEAU DE TABLE MONOBLOC LAME SCIE
TABLE KNIFE SOLID HANDLE SERRATED
CUCHILLO DE MESA HOJA SIERRA
23 CM - 9 IN^{7/16}



159451
COUTEAU À STEAK MONOBLOC LAME SCIE
STEAK KNIFE SOLID HANDLE SERRATED
CUCHILLO DE STEAK HOJA SIERRA
23,5 CM - 9 IN^{1/4}



205541
CUILLÈRE DE TABLE
TABLE/PASTA SPOON
CUCHARA DE MESA
20,9 CM - 8 IN^{1/4}



205542
CUILLÈRE À SOUPE ANGLAISE
BOUILLON SPOON, ROUND
CUCHARA DE CONSOMÉ
17,8 CM - 7 IN



205547
CUILLÈRE À DESSERT
DESSERT/SOUP SPOON, OVAL
CUCHARA DE POSTRE
18,4 CM - 7 IN^{1/4}



205546
FOURCHETTE À DESSERT
DESSERT/SALAD FORK
TENEDOR DE POSTRE
18,4 CM - 7 IN^{1/4}



159492
COUTEAU À DESSERT MONOBLOC LAME UNIE
DESSERT KNIFE SOLID HANDLE
CUCHILLO DE POSTRE HOJA LISA
20,4 CM - 8 IN^{1/16}



208625
COUTEAU À DESSERT MONOBLOC LAME SCIE
DESSERT KNIFE SOLID HANDLE SERRATED
CUCHILLO DE POSTRE HOJA SIERRA
20,7 CM - 8 IN^{1/8}



154612
COUTEAU À BEURRE MONOBLOC LAME UNIE
BUTTER KNIFE SOLID HANDLE
CUCHILLO DE MANTEQUILLA HOJA LISA
19,4 CM - 7 IN^{5/8}



205544
FOURCHETTE À POISSON
FISH FORK
TENEDOR DE PESCADO
18,4 CM - 7 IN^{1/4}



205545
COUTEAU À POISSON/ GOURMET
GOURMET/FISH KNIFE
CUCHILLO DE PESCADO
20,7 CM - 8 IN^{1/8}



205543
CUILLÈRE À CAFÉ
COFFEE/TEA SPOON
CUCHARA DE CAFÉ
14 CM - 5 IN^{1/2}



159512
CUILLÈRE À MOKA
DEMI TASSE SPOON
CUCHARA DE MOKA
11,1 CM - 4 IN^{3/8}



190018
CUILLÈRE À SODA
ICED TEA SPOON
CUCHARA DE SODA/HELADO
19 CM - 7 IN^{1/2}



205548
FOURCHETTE À GÂTEAUX/ COCKTAIL
PASTRY/COCKTAIL FORK
TENEDOR DE PASTEL
14,1 CM - 5 IN^{9/16}



190424
FOURCHETTE À HÙITRES
OYSTER FORK
TENEDOR DE OSTRAS
14,5 CM - 5 IN^{17/16}



159501
FOURCHETTE DE SERVICE
SERVING FORK
TENEDOR DE SERVICIO/ENSALADA
26 CM - 10 IN^{1/4}

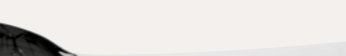

159500
CUILLÈRE DE SERVICE
SERVING SPOON
CUCHARA DE SERVICIO/ENSALADA
26 CM - 10 IN^{1/4}



159504
SERVICE À SALADE
SALAD SERVING SET
SET SERVICIO DE ENSALADA
30 CM - 11 IN^{13/16}



159490
PELLE À TARTE MONOBLOC
PASTRY SERVER SOLID HANDLE
PALA PARA TARTA
26,2 CM - 10 IN^{1/4}

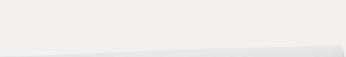

153193
LOUCHE
SOUP LADLE
CAZO
29,7 CM - 11 IN^{11/16}



154606
CUILLÈRE À SAUCE
SAUCE LADLE
CUCHARA DE SALSA
18,5 CM - 7 IN^{37/16}





233011
FOURCHETTE DE TABLE
TABLE FORK
TENEDOR DE MESA
20,5 CM - 8 IN^{7/8}



233013
COUTEAU DE TABLE MONOBLOC À BOUT POINTU LAME SCIE
TABLE KNIFE SOLID HANDLE POINTED BLADE SERRATED
CUCHILLO DE MESA HOJA SIERRA
23,3 CM - 9 IN^{3/8}



233014
COUTEAU DE TABLE MONOBLOC À BOUT ROND LAME SCIE
TABLE KNIFE SOLID HANDLE ROUNDED BLADE SERRATED
CUCHILLO DE MESA HOJA SIERRA
23,3 CM - 9 IN^{3/8}



229520
COUTEAU DE TABLE MONOCOQUE MANCHE ORFÈVRE LAME UNIE
TABLE KNIFE HOLLOW HANDLE
CUCHILLO DE MESA ENMANGADO HOJA LISA
23,3 CM - 9 IN^{3/8}



233012
CUILLÈRE DE TABLE
TABLE/ PASTA SPOON
CUCHARA DE MESA
20,5 CM - 8 IN^{7/8}



233022
CUILLÈRE À SOUPE ANGLAISE
BOUILLON SPOON, ROUND
CUCHARA DE CONSOMÉ
18,5 CM - 7 IN^{5/8}



233018
CUILLÈRE À DESSERT
DESSERT/SOUP SPOON
CUCHARA DE POSTRE
18,5 CM - 7 IN^{5/8}



233017
FOURCHETTE À DESSERT
DESSERT/SALAD FORK
TENEDOR DE POSTRE
18,5 CM - 7 IN^{5/8}



233019
COUTEAU À DESSERT MONOBLOC À BOUT ROND LAME UNIE
DESSERT KNIFE SOLID HANDLE ROUNDED BLADE
CUCHILLO DE POSTRE HOJA LISA
20,9 CM - 8 IN^{1/4}



233023
COUTEAU À BEURRE MONOBLOC LAME UNIE
BUTTER KNIFE SOLID HANDLE
CUCHILLO DE MANTEQUILLA HOJA LISA
17,5 CM - 6 IN^{7/8}



233021
CUILLÈRE GOURMET
GOURMET SPOON
CUCHARA PARA SALSA
18,5 CM - 7 IN^{5/8}



233015
CUILLÈRE À CAFÉ
COFFEE/TEA SPOON
CUCHARA DE CAFÉ
13,9 CM - 5 IN^{1/2}



233016
CUILLÈRE À MOKA
DEMI TASSE SPOON
CUCHARA DE MOKA
11,7 CM - 4 IN^{5/8}



233020
FOURCHETTE À GÂTEAUX/ COCKTAIL
PASTRY/COCKTAIL FORK
TENEDOR DE PASTEL
13,9 CM - 5 IN^{1/2}



233024
FOURCHETTE DE SERVICE
SERVING FORK
TENEDOR DE SERVICIO/ENSALADA
26,3 CM - 10 IN^{3/8}



233025
CUILLÈRE DE SERVICE
SERVING SPOON
CUCHARA DE SERVICIO/ENSALADA
26,3 CM - 10 IN^{3/8}

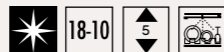

L'ABUS D'ALCOOL EST DANGEREUX POUR LA SANTÉ
DEGRENNÉ PROMOTES RESPONSIBLE DRINKING AND DISCOURAGES ALCOHOL MISUSE
EL ABUSO DE ALCOHOL ES PELIGROSO PARA LA SALUD



LES COUVERTS
FLATWARE - CUBIERTOS

























GUEST MIROIR

LES COUVERTS
PLATWARE - CUBIERTOS



DEGRENE



- | | |
|--|--|
| 
197507
FOURCHETTE DE TABLE
TABLE FORK
TENEDOR DE MESA
21,3 CM - 8 IN ^{3/8} | 
197515
COUPEAU À POISSON/
GOURMET
GOURMET/FISH KNIFE
CUCHILLO DE PESCADO
21,3 CM - 8 IN ^{3/8} |
| 
197509
COUPEAU DE TABLE
MONOBLOC LAME SCIE
TABLE KNIFE SOLID HANDLE SERRATED
CUCHILLO DE MESA HOJA SIERRA
23,2 CM - 9 IN ^{1/8} | 
197508
CUILLÈRE À CAFÉ
COFFEE/TEA SPOON
CUCHARA DE CAFÉ
14,3 CM - 5 IN ^{5/8} |
| <p>NEW</p> 
235481
COUPEAU DE TABLE
MONOBLOC LAME SCIE
TABLE KNIFE SOLID HANDLE SERRATED
CUCHILLO DE MESA HOJA SIERRA
23,7 CM - 9 IN ^{5/16} | 
197510
CUILLÈRE À MOKA
DEMI TASSE SPOON
CUCHARA DE MOKA
11,7 CM - 4 IN ^{5/8} |
| 
197521
COUPEAU À STEAK
MONOBLOC LAME SCIE
STEAK KNIFE SOLID HANDLE SERRATED
CUCHILLO DE STEAK HOJA SIERRA
23,2 CM - 9 IN ^{1/8} | 
190018
CUILLÈRE À SODA
ICED TEA SPOON
CUCHARA DE SODA/HELADO
19 CM - 7 IN ^{1/2} |
| 
197506
CUILLÈRE DE TABLE
TABLE/ PASTA SPOON
CUCHARA DE MESA
21,6 CM - 8 IN ^{1/2} | 
197516
FOURCHETTE À GÂTEAUX/
COCKTAIL
PASTRY/COCKTAIL FORK
TENEDOR DE PASTEL
13,9 CM - 5 IN ^{1/2} |
| 
197518
CUILLÈRE À SOUPE ANGLAISE
BOUILLON SPOON, ROUND
CUCHARA DE CONSOMÉ
18,5 CM - 7 IN ^{5/16} | 
190424
FOURCHETTE À HUÎTRES
OYSTER FORK
TENEDOR DE OSTRAS
14,1 CM - 5 IN ^{5/16} |
| 
197512
CUILLÈRE À DESSERT
DESSERT/SOUP SPOON, OVAL
CUCHARA DE POSTRE
19,5 CM - 7 IN ^{17/16} | 
197522
FOURCHETTE DE SERVICE
SERVING FORK
TENEDOR DE SERVICIO/ENSALADA
26,6 CM - 10 IN ^{1/2} |
| 
197511
FOURCHETTE À DESSERT
DESSERT/SALAD FORK
TENEDOR DE POSTRE
19,2 CM - 7 IN ^{3/16} | 
197523
CUILLÈRE DE SERVICE
SERVING SPOON
CUCHARA DE SERVICIO/ENSALADA
27 CM - 10 IN ^{5/8} |
| 
210629
COUPEAU À DESSERT
MONOBLOC LAME SCIE
DESSERT KNIFE SOLID HANDLE
SERRATED
CUCHILLO DE POSTRE HOJA SIERRA
20,9 CM - 8 IN ^{3/16} | 
197525
SERVICE À SALADE
SALAD SERVING SET
SET SERVICIO DE ENSALADA
30 CM - 11 IN ^{13/16} |
| <p>NEW</p> 
235482
COUPEAU DE TABLE
MONOBLOC LAME SCIE
TABLE KNIFE SOLID HANDLE SERRATED
CUCHILLO DE MESA HOJA SIERRA
21,3 CM - 8 IN ^{3/8} | 
197527
PELLE À TARTE
MONOBLOC
PASTRY SERVER SOLID HANDLE
PALA PARA TARTA
25,1 CM - 9 IN ^{7/8} |
| 
197520
COUPEAU À BEURRE
MONOBLOC LAME UNIE
BUTTER KNIFE SOLID HANDLE
CUCHILLO PARA MANTEQUILLA HOJA LISA
19,3 CM - 7 IN ^{5/8} | 
153193
LOUCHE
SOUP LADLE
CAZO
29,7 CM - 11 IN ^{11/16} |
| 
197514
FOURCHETTE À POISSON
FISH FORK
TENEDOR DE PESCADO
19,2 CM - 7 IN ^{3/16} | 
154606
CUILLÈRE À SAUCE
SAUCE LADLE
CUCHARA DE SALSA
18,5 CM - 7 IN ^{3/8} |

LABUS D'ALCOOL EST DANGEREUX POUR LA SANTÉ
 DEGRENE PROMOTES RESPONSIBLE DRINKING AND DISCOURAGES ALCOHOL MISUSE
 EL ABUSO DE ALCOHOL ES PELIGROSO PARA LA SALUD





223482
FOURCHETTE DE TABLE
TABLE FORK
TENEDOR DE MESA
21,3 CM - 8 IN^{3/8}



202995
COUPEAU DE TABLE
MONOBLOC LAME SCIE
TABLE KNIFE SOLID HANDLE SERRATED
CUCHILLO DE MESA HOJA SIERRA
23,2 CM - 9 IN^{1/8}



203017
COUPEAU À STEAK
MONOBLOC LAME SCIE
STEAK KNIFE SOLID HANDLE SERRATED
CUCHILLO DE STEAK HOJA SIERRA
23,2 CM - 9 IN^{1/8}



223481
CUILLÈRE DE TABLE
TABLE/ PASTA SPOON
CUCHARA DE MESA
21,6 CM - 8 IN^{1/2}



223491
CUILLÈRE À SOUPE ANGLAISE
BOUILLON SPOON, ROUND
CUCHARA DE CONSOMÉ
18,5 CM - 7 IN^{5/16}



223486
CUILLÈRE À DESSERT
DESSERT/SOUP SPOON, OVAL
CUCHARA DE POSTRE
19,5 CM - 7 IN^{17/16}



223485
FOURCHETTE À DESSERT
DESSERT/SALAD FORK
TENEDOR DE POSTRE
19,2 CM - 7 IN^{3/16}



210630
COUPEAU À DESSERT
MONOBLOC LAME SCIE
DESSERT KNIFE SOLID HANDLE
SERRATED
CUCHILLO DE POSTRE HOJA SIERRA
20,9 CM - 8 IN^{3/16}



203016
COUPEAU À BEURRE
MONOBLOC LAME UNIE
BUTTER KNIFE SOLID HANDLE
CUCHILLO DE MANTEQUILLA HOJA LISA
19,3 CM - 7 IN^{5/16}



223487
FOURCHETTE À POISSON
FISH FORK
TENEDOR DE PESCADO
19,2 CM - 7 IN^{3/16}



223488
COUPEAU À POISSON/
GOURMET
GOURMET/FISH KNIFE
CUCHILLO DE PESCADO
21,3 CM - 8 IN^{3/8}



223483
CUILLÈRE À CAFÉ
COFFEE/TEA SPOON
CUCHARA DE CAFÉ
14,3 CM - 5 IN^{5/8}



223484
CUILLÈRE À MOKA
DEMI TASSE SPOON
CUCHARA DE MOKA
11,7 CM - 4 IN^{5/8}



223492
CUILLÈRE À SODA
ICED TEA SPOON
CUCHARA DE SODA/HELADO
18,9 CM - 7 IN^{7/16}



223489
FOURCHETTE À GÂTEAUX/
COCKTAIL
PASTRY/COCKTAIL FORK
TENEDOR DE PASTEL
13,9 CM - 5 IN^{1/2}



223493
FOURCHETTE DE SERVICE
SERVING FORK
TENEDOR DE SERVICIO/ENSALADA
26,6 CM - 10 IN^{1/2}



223494
CUILLÈRE DE SERVICE
SERVING SPOON
CUCHARA DE SERVICIO/ENSALADA
27 CM - 10 IN^{5/8}



223496
SERVICE À SALADE
SALAD SERVING SET
SET SERVICIO DE ENSALADA
30 CM - 11 IN^{13/16}



223497
PELLE À TARTE
MONOBLOC
PASTRY SERVER SOLID HANDLE
PALA PARA TARTA
25,1 CM - 9 IN^{7/8}

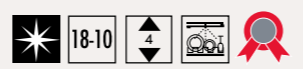

LES COUVERTS
FLATWARE - CUBIERTOS

GUEST CUIVRE
COPPER



230848
FOURCHETTE DE TABLE
TABLE FORK
TENEDOR DE MESA
21,3 CM - 8 IN^{3/8}



230850
**COUTEAU DE TABLE
MONOBLOC LAME SCIE**
TABLE KNIFE SOLID HANDLE SERRATED
CUCHILLO DE MESA HOJA SIERRA
23,2 CM - 9 IN^{1/8}



230849
CUILLÈRE DE TABLE
TABLE/ PASTA SPOON
CUCHARA DE MESA
21,6 CM - 8 IN^{1/2}



230854
CUILLÈRE À DESSERT
DESSERT/SOUP SPOON, OVAL
CUCHARA DE POSTRE
19,5 CM - 7 IN^{3/16}



230853
FOURCHETTE À DESSERT
DESSERT/SALAD FORK
TENEDOR DE POSTRE
19,2 CM - 7 IN^{3/16}



230855
**COUTEAU À DESSERT
MONOBLOC LAME SCIE**
DESSERT KNIFE SOLID HANDLE
SERRATED
CUCHILLO DE POSTRE HOJA SIERRA
20,9 CM - 8 IN^{3/16}



230851
CUILLÈRE À CAFÉ
COFFEE/TEA SPOON
CUCHARA DE CAFÉ
14,3 CM - 5 IN^{3/8}



230852
CUILLÈRE À MOKA
DEMI TASSE SPOON
CUCHARA DE MOKA
11,7 CM - 4 IN^{5/8}



LES COUVERTS
FLATWARE - CUBIERTOS



©Patrick ROUGEREAU

- 

217139
FOURCHETTE DE TABLE
TABLE FORK
TENEDOR DE MESA
21,3 CM - 8 IN^{3/8}
- 

217140
**COUPEAU DE TABLE
MONOBLOC LAME SCIE**
TABLE KNIFE SOLID HANDLE SERRATED
CUCHILLO DE MESA HOJA SIERRA
23,2 CM - 9 IN^{1/8}
- 

230339
**COUPEAU À STEAK
MONOBLOC LAME SCIE**
STEAK KNIFE SOLID HANDLE SERRATED
CUCHILLO DE STEAK HOJA SIERRA
23,2 CM - 9 IN^{1/8}
- 

217141
CUILLÈRE DE TABLE
TABLE/ PASTA SPOON
CUCHARA DE MESA
21,6 CM - 8 IN^{1/2}
- 

217143
CUILLÈRE À DESSERT
DESSERT/SOUP SPOON, OVAL
CUCHARA DE POSTRE
19,5 CM - 7 IN^{11/16}
- 

217144
FOURCHETTE À DESSERT
DESSERT/SALAD FORK
TENEDOR DE POSTRE
19,2 CM - 7 IN^{3/16}
- 

217145
**COUPEAU À DESSERT
MONOBLOC LAME SCIE**
DESSERT KNIFE SOLID HANDLE
SERRATED
CUCHILLO DE POSTRE HOJA SIERRA
20,9 CM - 8 IN^{3/16}

- 

232307
TARTINEUR
BUTTER SPREADER
ESPATULIN PARA MANTEQUILLA
16 CM - 6 IN^{5/16}
- 

230411
FOURCHETTE À POISSON
FISH FORK
TENEDOR DE PESCADO
19,2 CM - 7 IN^{3/16}
- 

230412
**COUPEAU À POISSON/
GOURMET**
GOURMET/FISH KNIFE
CUCHILLO DE PESCADO
21,3 CM - 8 IN^{3/8}
- 

217142
CUILLÈRE À CAFÉ
COFFEE/TEA SPOON
CUCHARA DE CAFÉ
14,3 CM - 5 IN^{3/8}
- 

217146
CUILLÈRE À MOKA
DEMI TASSE SPOON
CUCHARA DE MOKA
11,7 CM - 4 IN^{5/8}

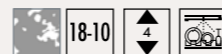



126355
FOURCHETTE DE TABLE
TABLE FORK
TENEDOR DE MESA
20,1 CM - 7 IN^{5/16}



126358
CUILLÈRE À CAFÉ
COFFEE/TEA SPOON
CUCHARA DE CAFÉ
13,7 CM - 5 IN^{3/8}



210731
COUTEAU DE TABLE
MONOBLOC LAME SCIE
TABLE KNIFE SOLID HANDLE SERRATED
CUCHILLO DE MESA HOJA SIERRA
23,5 CM - 9 IN^{1/4}



140852
CUILLÈRE À MOKA
DEMI TASSE SPOON
CUCHARA DE MOKA
11 CM - 4 IN^{5/16}



207189
COUTEAU À STEAK
MONOBLOC LAME SCIE
STEAK KNIFE SOLID HANDLE SERRATED
CUCHILLO DE STEAK HOJA SIERRA
23,6 CM - 9 IN^{5/16}



189973
CUILLÈRE À SODA
ICED TEA SPOON
CUCHARA DE SODA/HELADO
19 CM - 7 IN^{1/2}



126352
CUILLÈRE DE TABLE
TABLE/ PASTA SPOON
CUCHARA DE MESA
20,3 CM - 8 IN



126383
FOURCHETTE À GÂTEAUX
COCKTAIL
PASTRY/COCKTAIL FORK
TENEDOR DE PASTEL
13,7 CM - 5 IN^{3/8}



140855
CUILLÈRE À SOUPE ANGLAISE
BOUILLON SPOON, ROUND
CUCHARA DE CONSOMÉ
17,9 CM - 7 IN^{7/16}



189974
FOURCHETTE À HUÎTRES
OYSTER FORK
TENEDOR DE OSTRAS
14,1 CM - 5 IN^{7/16}



126368
CUILLÈRE À DESSERT
DESSERT/SOUP SPOON, OVAL
CUCHARA DE POSTRE
17,8 CM - 7 IN



231218
FOURCHETTE DE SERVICE
SERVING FORK
TENEDOR DE SERVICIO/ENSALADA
26,6 CM - 10 IN^{1/2}



126371
FOURCHETTE À DESSERT
DESSERT/SALAD FORK
TENEDOR DE POSTRE
17,7 CM - 6 IN^{5/16}



231219
CUILLÈRE DE SERVICE
SERVING SPOON
CUCHARA DE SERVICIO/ENSALADA
26,6 CM - 10 IN^{1/2}



210732
COUTEAU À DESSERT
MONOBLOC LAME UNIE
DESSERT KNIFE SOLID HANDLE
CUCHILLO DE POSTRE HOJA LISA
20,7 CM - 8 IN^{1/16}



231221
PELLE À TARTE
MONOBLOC
PASTRY SERVER SOLID HANDLE
PALA PARA TARTA
25,2 CM - 9 IN^{5/16}



189971
COUTEAU À BEURRE
MONOBLOC LAME UNIE
BUTTER KNIFE SOLID HANDLE
CUCHILLO DE MANTEQUILLA HOJA LISA
18,9 CM - 7 IN^{7/16}



231220
LOUCHE
SOUP LADLE
CAZO
29 CM - 11 IN^{7/16}



126377
FOURCHETTE À POISSON
FISH FORK
TENEDOR DE PESCADO
17,7 CM - 6 IN^{5/16}



181181
COUTEAU À POISSON/
GOURMET
GOURMET/FISH KNIFE
CUCHILLO DE PESCADO
20,1 CM - 7 IN^{5/16}





DEGRENE

ASTRÉE MIROIR

LES COUVERTS
FLATWARE - CUBIERTOS





- 

**153188
FOURCHETTE DE TABLE**
TABLE FORK
TENEDOR DE MESA
20,7 CM - 8 IN^{5/8}
- 

**153196
COUTEAU DE TABLE
MONOBLOC LAME SCIE**
TABLE KNIFE SOLID HANDLE SERRATED
CUCHILLO DE MESA HOJA SIERRA
23,5 CM - 9 IN^{1/4}
- 

**122418
COUTEAU À STEAK
MONOBLOC LAME SCIE**
STEAK KNIFE SOLID HANDLE SERRATED
CUCHILLO DE STEAK HOJA SIERRA
22,1 CM - 8 IN^{7/16}
- 

**153185
CUILLÈRE DE TABLE**
TABLE/ PASTA SPOON
CUCHARA DE MESA
20,7 CM - 8 IN^{5/8}
- 

**184758
CUILLÈRE À SOUPE ANGLAISE**
BOUILLON SPOON, ROUND
CUCHARA DE CONSOMÉ
18,3 CM - 7 IN^{3/16}
- 

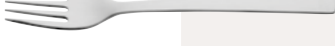
**153209
CUILLÈRE À DESSERT**
DESSERT/SOUP SPOON, OVAL
CUCHARA DE POSTRE
18,6 CM - 7 IN^{5/16}
- 

**153212
FOURCHETTE À DESSERT**
DESSERT/SALAD FORK
TENEDOR DE POSTRE
18,6 CM - 7 IN^{5/16}
- 

**153200
COUTEAU À DESSERT
MONOBLOC LAME UNIE**
DESSERT KNIFE SOLID HANDLE
CUCHILLO DE POSTRE HOJA LISA
21,1 CM - 8 IN^{5/16}
- 

**154612
COUTEAU À BEURRE
MONOBLOC LAME UNIE**
BUTTER KNIFE SOLID HANDLE
CUCHILLO DE MANTEQUILLA HOJA LISA
19,4 CM - 7 IN^{5/8}
- 

**153203
FOURCHETTE À POISSON**
FISH FORK
TENEDOR DE PESCADO
18,6 CM - 7 IN^{5/16}
- 

**153206
COUTEAU À POISSON/
GOURMET**
GOURMET/FISH KNIFE
CUCHILLO DE PESCADO
21,1 CM - 8 IN^{5/16}
- 

**153191
CUILLÈRE À CAFÉ**
COFFEE/TEA SPOON
CUCHARA DE CAFÉ
14,1 CM - 5 IN^{9/16}
- 

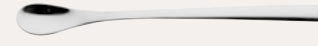
**154609
CUILLÈRE À MOKA**
DEMI TASSE SPOON
CUCHARA DE MOKA
11,1 CM - 4 IN^{3/8}
- 

**190018
CUILLÈRE À SODA**
ICED TEA SPOON
CUCHARA DE SODA/HELADO
19 CM - 7 IN^{1/2}
- 

**197516
FOURCHETTE À GÂTEAUX
COCKTAIL**
PASTRY/COCKTAIL FORK
TENEDOR DE PASTEL
13,9 CM - 5 IN^{1/2}
- 

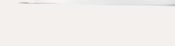
**190424
FOURCHETTE À HUÎTRES**
OYSTER FORK
TENEDOR DE OSTRAS
14,1 CM - 5 IN^{7/16}
- 

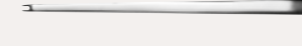
**162728
FOURCHETTE /PIQUE À
ESCARGOTS/COCKTAIL**
COCKTAIL/ SNAIL FORK
TENEDOR DE CARACOL/COCKTAIL
10,8 CM - 4 IN^{1/4}
- 

**162730
CURETTE À CRUSTACÉS**
SEAFOOD SCRAPER
RASQUETA PARA CANGREJO
19,1 CM - 7 IN^{1/2}
- 

**197522
FOURCHETTE DE SERVICE**
SERVING FORK
TENEDOR DE SERVICIO/ENSALADA
26,6 CM - 10 IN^{1/2}
- 

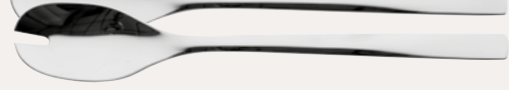
**197523
CUILLÈRE DE SERVICE**
SERVING SPOON
CUCHARA DE SERVICIO/ENSALADA
27 CM - 10 IN^{5/8}
- 

**197525
SERVICE À SALADE**
SALAD SERVING SET
SET SERVICIO DE ENSALADA
30 CM - 11 IN^{3/16}
- 

**197527
PELLE À TARTE MONOBLOC**
PASTRY SERVER SOLID HANDLE
PALA PARA TARTA
25,1 CM - 9 IN^{7/16}
- 

**153193
LOUCHE**
SOUP LADLE
CAZO
29,7 CM - 11 IN^{11/16}
- 

**154606
LOUCHE À SAUCE**
SAUCE LADLE
CAZO PARA SALSA
18,5 CM - 7 IN^{3/8}



ASTRÉE CISELÉ

LES COUVERTS
FLATWARE - CUBIERTOS

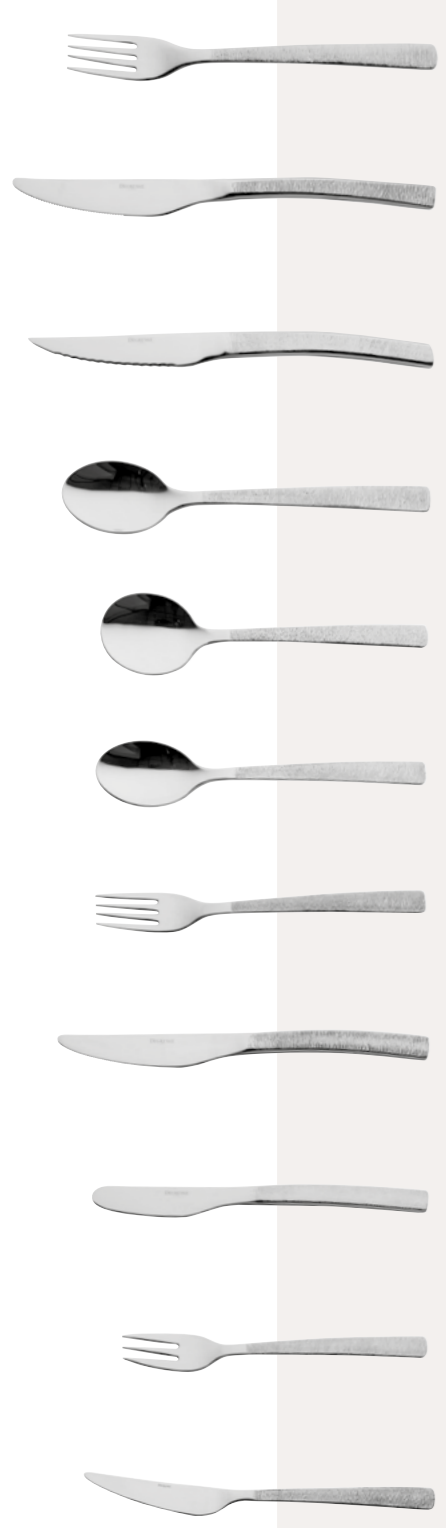

153998
FOURCHETTE DE TABLE
TABLE FORK
TENEDOR DE MESA
20,7 CM - 8 IN^{7/8}

154002
COUTEAU DE TABLE
MONOBLOC LAME SCIE
TABLE KNIFE SOLID HANDLE SERRATED
CUCHILLO DE MESA HOJA SIERRA
23,5 CM - 9 IN^{1/4}

199761
COUTEAU À STEAK
MONOBLOC LAME SCIE
STEAK KNIFE SOLID HANDLE SERRATED
CUCHILLO DE STEAK HOJA SIERRA
22,8 CM - 9 IN

153996
CUILLÈRE DE TABLE
TABLE/ PASTA SPOON
CUCHARA DE MESA
20,7 CM - 8 IN^{7/8}

190015
CUILLÈRE À SOUPE ANGLAISE
BOUILLON SPOON, ROUND
CUCHARA DE CONSOMÉ
18,3 CM - 7 IN^{3/16}

154571
CUILLÈRE À DESSERT
DESSERT/SOUP SPOON, OVAL
CUCHARA DE POSTRE
18,6 CM - 7 IN^{5/16}

154574
FOURCHETTE À DESSERT
DESSERT/SALAD FORK
TENEDOR DE POSTRE
18,6 CM - 7 IN^{5/16}

154555
COUTEAU À DESSERT
MONOBLOC LAME UNIE
DESSERT KNIFE SOLID HANDLE
CUCHILLO DE POSTRE HOJA LISA
21,1 CM - 8 IN^{5/16}

154580
COUTEAU À BEURRE
MONOBLOC LAME UNIE
BUTTER KNIFE SOLID HANDLE
CUCHILLO DE MANTEQUILLA HOJA LISA
19,4 CM - 7 IN^{5/8}

154558
FOURCHETTE À POISSON
FISH FORK
TENEDOR DE PESCADO
18,7 CM - 7 IN^{3/8}

154561
COUTEAU À POISSON
FISH KNIFE
CUCHILLO DE PESCADO
21,1 CM - 8 IN^{5/16}



154001
CUILLÈRE À CAFÉ
COFFEE/TEA SPOON
CUCHARA DE CAFÉ
14,1 CM - 5 IN^{2/16}

154577
CUILLÈRE À MOKA
DEMI TASSE SPOON
CUCHARA DE MOKA
11,1 CM - 4 IN^{3/8}

190016
CUILLÈRE À SODA
ICED TEA SPOON
CUCHARA DE SODA/HELADO
19 CM - 7 IN^{1/2}

154547
FOURCHETTE À GÂTEAUX
COCKTAIL
PASTRY/COCKTAIL FORK
TENEDOR DE PASTEL
14 CM - 5 IN^{1/2}

154563
FOURCHETTE DE SERVICE
SERVING FORK
TENEDOR DE SERVICIO/ENSALADA
25,1 CM - 9 IN^{7/8}

154562
CUILLÈRE DE SERVICE
SERVING SPOON
CUCHARA DE SERVICIO/ENSALADA
25,5 CM - 10 IN^{1/16}

154566
SERVICE À SALADE
SALAD SERVING SET
SET SERVICIO DE ENSALADA
24,3 CM - 9 IN^{9/16}

154552
PELLE À TARTE MONOBLOC
PASTRY SERVER SOLID HANDLE
PALA PARA TARTA
25,3 CM - 9 IN^{15/16}

154550
LOUCHE
SOUP LADLE
CAZO
29,7 CM - 11 IN^{10/16}



©Patrick ROUGEREAU



226167
FOURCHETTE DE TABLE
TABLE FORK
TENEDOR DE MESA
21 CM - 8 IN^{1/4}



226177
COUPEAU DE TABLE
MONOBLOC LAME SCIE N°1
TABLE KNIFE SOLID HANDLE SERRATED N°1
CUCHILLO DE MESA HOJA SIERRA N°1
22,8 CM - 9 IN



226176
COUPEAU À STEAK
MONOBLOC LAME SCIE N°2
STEAK KNIFE SOLID HANDLE SERRATED N°2
CUCHILLO DE STEAK HOJA SIERRA N°2
22,8 CM - 9 IN



226168
CUILLÈRE DE TABLE
TABLE/ PASTA SPOON
CUCHARA DE MESA
21 CM - 8 IN^{1/4}



226172
CUILLÈRE À DESSERT
DESSERT/SOUP SPOON, OVAL
CUCHARA DE POSTRE
18,9 CM - 7 IN^{7/16}



226171
FOURCHETTE À DESSERT
DESSERT/SALAD FORK
TENEDOR DE POSTRE
18,9 CM - 7 IN^{7/16}



226179
COUPEAU À DESSERT
MONOBLOC LAME UNIE N°1
DESSERT KNIFE SOLID HANDLE N°1
CUCHILLO DE POSTRE HOJA LISA N°1
20,5 CM - 8 IN^{1/16}



226178
COUPEAU À DESSERT
MONOBLOC LAME UNIE N°2
DESSERT KNIFE SOLID HANDLE N°2
CUCHILLO DE POSTRE HOJA LISA N°2
20,5 CM - 8 IN^{1/16}



226171
FOURCHETTE À POISSON
FISH FORK
TENEDOR DE PESCADO
18,9 CM - 7 IN^{7/16}



226173
COUPEAU À POISSON/
GOURMET
GOURMET/FISH KNIFE
CUCHILLO DE PESCADO
21 CM - 8 IN^{1/4}



226169
CUILLÈRE À CAFÉ
COFFEE/TEA SPOON
CUCHARA DE CAFÉ
14,5 CM - 5 IN^{17/16}



226170
CUILLÈRE À MOKA
DEMI TASSE SPOON
CUCHARA DE MOKA
11,6 CM - 4 IN^{9/16}

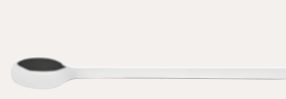

226175
CUILLÈRE À SODA
ICED TEA SPOON
CUCHARA DE SODA/HELADO
19 CM - 7 IN^{1/2}



226174
FOURCHETTE À GÂTEAUX/
COCKTAIL
PASTRY/COCKTAIL FORK
TENEDOR DE PASTEL
14,5 CM - 5 IN^{17/16}



190424
FOURCHETTE À HÙÎTRES
OYSTER FORK
TENEDOR DE OSTRAS
14,1 CM - 5 IN^{9/16}



197522
FOURCHETTE DE SERVICE
SERVING FORK
TENEDOR DE SERVICIO/ENSALADA
26,6 CM - 10 IN^{1/2}



197523
CUILLÈRE DE SERVICE
SERVING SPOON
CUCHARA DE SERVICIO/ENSALADA
27 CM - 10 IN^{5/8}



197525
SERVICE À SALADE
SALAD SERVING SET
SET SERVICIO DE ENSALADA
30 CM - 11 IN^{13/16}



197527
PELLE À TARTE
MONOBLOC
PASTRY SERVER SOLID HANDLE
PALA PARA TARTA
25,1 CM - 9 IN^{7/8}



153193
LOUCHE
SOUP LADLE
CAZO
29,7 CM - 11 IN^{17/16}



154606
LOUCHE À SAUCE
SAUCE LADLE
CAZO PARA SALSA
18,5 CM - 7 IN^{57/16}

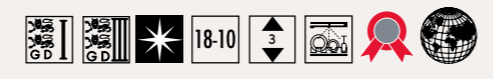

LES COUVERTS
FLATWARE - CUBIERTOS





163580
FOURCHETTE DE TABLE
TABLE FORK
TENEDOR DE MESA
20,9 CM - 8 IN^{3/16}



189973
CUILLÈRE À SODA
ICED TEA SPOON
CUCHARA DE SODA/HELADO
19 CM - 7 IN^{1/2}



189969
COUTEAU DE TABLE MONOBLOC LAME SCIE
TABLE KNIFE SOLID HANDLE SERRATED
CUCHILLO DE MESA HOJA SIERRA
22,9 CM - 9 IN



164705
FOURCHETTE À GÂTEAUX/ COCKTAIL
PASTRY/COCKTAIL FORK
TENEDOR DE PASTEL
14,4 CM - 5 IN^{11/16}



207189
COUTEAU À STEAK MONOBLOC LAME SCIE
STEAK KNIFE SOLID HANDLE SERRATED
CUCHILLO DE STEAK HOJA SIERRA
23,6 CM - 9 IN^{5/16}



189974
FOURCHETTE À HÙÎTRES
OYSTER FORK
TENEDOR DE OSTRAS
14,1 CM - 5 IN^{9/16}



163579
CUILLÈRE DE TABLE
TABLE/PASTA SPOON
CUCHARA DE MESA
21,1 CM - 8 IN^{5/16}



162728
FOURCHETTE /PIQUE À ESCARGOTS/COCKTAIL
COCKTAIL, SNAIL FORK
TENEDOR DE CARACOL/COCKTAIL
10,8 CM - 4 IN^{1/4}



164713
CUILLÈRE À DESSERT
DESSERT/SOUP SPOON, OVAL
CUCHARA DE POSTRE
19 CM - 7 IN^{1/2}



162730
CURETTE À CRUSTACÉS
SEAFOOD SCRAPER
RASQUETA PARA CANGREJO
19,1 CM - 7 IN^{1/2}



164714
FOURCHETTE À DESSERT
DESSERT/SALAD FORK
TENEDOR DE POSTRE
18,9 CM - 7 IN^{7/16}



231218
FOURCHETTE DE SERVICE
SERVING FORK
TENEDOR DE SERVICIO/ENSALADA
26,6 CM - 10 IN^{1/2}



210627
COUTEAU À DESSERT MONOBLOC LAME SCIE
DESSERT KNIFE SOLID HANDLE SERRATED
CUCHILLO DE POSTRE HOJA SIERRA
18,9 CM - 7 IN^{7/16}



231219
CUILLÈRE DE SERVICE
SERVING SPOON
CUCHARA DE SERVICIO/ENSALADA
26,6 CM - 10 IN^{1/2}



189971
COUTEAU À BEURRE MONOBLOC LAME UNIE
BUTTER KNIFE SOLID HANDLE
CUCHILLO DE MANTEQUILLA HOJA LISA
18,8 CM - 7 IN^{3/8}



231221
PELLE À TARTE MONOBLOC
PASTRY SERVER SOLID HANDLE
PALA PARA TARTA
25,2 CM - 9 IN^{15/16}



164708
FOURCHETTE À POISSON
FISH FORK
TENEDOR DE PESCADO
18,9 CM - 7 IN^{7/16}



231220
LOUCHE
SOUP LADLE
CAZO
29 CM - 11 IN^{7/16}



164709
COUTEAU À POISSON/ GOURMET
GOURMET/FISH KNIFE
CUCHILLO DE PESCADO
21 CM - 8 IN^{1/4}



163581
CUILLÈRE À CAFÉ
COFFEE/TEA SPOON
CUCHARA DE CAFÉ
14,3 CM - 5 IN^{5/8}



164715
CUILLÈRE À MOKA/TOUILLETTE
DEMI TASSE SPOON
CUCHARA DE MOKA
11 CM - 4 IN^{3/16}



©Patrick ROUGEREAU



111894
FOURCHETTE DE TABLE
TABLE FORK
TENEDOR DE MESA
20,4 CM - 8 IN^{7/16}



111921
COÛTEAU DE TABLE MONOBLOC LAME SCIE
TABLE KNIFE SOLID HANDLE SERRATED
CUCHILLO DE MESA HOJA SIERRA
23 CM - 9 IN^{1/16}



111891
CUILLÈRE DE TABLE
TABLE/ PASTA SPOON
CUCHARA DE MESA
20,4 CM - 8 IN^{7/16}



111904
CUILLÈRE À DESSERT
DESSERT/SOUP SPOON, OVAL
CUCHARA DE POSTRE
18 CM - 7 IN^{7/16}



111907
FOURCHETTE À DESSERT
DESSERT/SALAD FORK
TENEDOR DE POSTRE
18 CM - 7 IN^{7/16}



210631
COÛTEAU À DESSERT MONOBLOC LAME SCIE
DESSERT KNIFE SOLID HANDLE SERRATED
CUCHILLO DE POSTRE HOJA SIERRA
20,3 CM - 8 IN



111897
CUILLÈRE À CAFÉ
COFFEE/TEA SPOON
CUCHARA DE CAFÉ
13,6 CM - 5 IN^{3/8}



114437
CUILLÈRE À MOKA
DEMI TASSE SPOON
CUCHARA DE MOKA
11 CM - 4 IN^{5/16}



LES COUVERTS
PLATWARE - CUBIERTOS

©Patrick ROUGEREAU

CARBONE - CARBON - CARBONO

205883
FOURCHETTE DE TABLE
TABLE FORK
TENEDOR DE MESA
21,6 CM - 8 IN^{1/2}



205885
**COUTEAU DE TABLE/STEAK
LAME SCIE**
STEAK/TABLE KNIFE SERRATED
CUCHILLO DE STEAK HOJA SIERRA
23 CM - 9 IN^{1/16}



205884
CUILLÈRE DE TABLE
TABLE/ PASTA SPOON
CUCHARA DE MESA
21,8 CM - 8 IN^{3/16}



205886
CUILLÈRE À CAFÉ
COFFEE/TEA SPOON
CUCHARA DE CAFÉ
15,2 CM - 6 IN



ROUGE - RED - ROJO

206782
FOURCHETTE DE TABLE
TABLE FORK
TENEDOR DE MESA
21,6 CM - 8 IN^{1/2}



205894
**COUTEAU DE TABLE/STEAK
LAME SCIE**
STEAK/TABLE KNIFE SERRATED
CUCHILLO DE STEAK HOJA SIERRA
23 CM - 9 IN^{1/16}



206783
CUILLÈRE DE TABLE
TABLE/ PASTA SPOON
CUCHARA DE MESA
21,8 CM - 8 IN^{3/16}



206784
CUILLÈRE À CAFÉ
COFFEE/TEA SPOON
CUCHARA DE CAFÉ
15,2 CM - 6 IN



BLANC - WHITE - BLANCO

210661
FOURCHETTE DE TABLE
TABLE FORK
TENEDOR DE MESA
21,6 CM - 8 IN^{1/2}



210658
**COUTEAU DE TABLE/STEAK
LAME SCIE**
STEAK/TABLE KNIFE SERRATED
CUCHILLO DE STEAK HOJA SIERRA
23 CM - 9 IN^{1/16}



210660
CUILLÈRE DE TABLE
TABLE/ PASTA SPOON
CUCHARA DE MESA
21,8 CM - 8 IN^{3/16}



210662
CUILLÈRE À CAFÉ
COFFEE/TEA SPOON
CUCHARA DE CAFÉ
15,2 CM - 6 IN



CÈPE - TAUPE - TOPO

226787
FOURCHETTE DE TABLE
TABLE FORK
TENEDOR DE MESA
21,6 CM - 8 IN^{1/2}



226789
**COUTEAU DE TABLE/STEAK
LAME SCIE**
STEAK/TABLE KNIFE SERRATED
CUCHILLO DE STEAK HOJA SIERRA
23 CM - 9 IN^{1/16}



226788
CUILLÈRE DE TABLE
TABLE/ PASTA SPOON
CUCHARA DE MESA
21,8 CM - 8 IN^{3/16}



226790
CUILLÈRE À CAFÉ
COFFEE/TEA SPOON
CUCHARA DE CAFÉ
15,2 CM - 6 IN^{5/8}



ATOLL - TEAL - VERDE AZULADO

226767
FOURCHETTE DE TABLE
TABLE FORK
TENEDOR DE MESA
21,6 CM - 8 IN^{1/2}



226769
**COUTEAU DE TABLE/STEAK
LAME SCIE**
STEAK/TABLE KNIFE SERRATED
CUCHILLO DE STEAK HOJA SIERRA
23 CM - 9 IN^{1/16}



226768
CUILLÈRE DE TABLE
TABLE/ PASTA SPOON
CUCHARA DE MESA
21,8 CM - 8 IN^{3/16}



226770
CUILLÈRE À CAFÉ
COFFEE/TEA SPOON
CUCHARA DE CAFÉ
15,2 CM - 6 IN



BLEU MARIN - STEEL BLUE - AZUL MARINO

226772
FOURCHETTE DE TABLE
TABLE FORK
TENEDOR DE MESA
21,6 CM - 8 IN^{1/2}



226774
**COUTEAU DE TABLE/STEAK
LAME SCIE**
STEAK/TABLE KNIFE SERRATED
CUCHILLO DE STEAK HOJA SIERRA
23 CM - 9 IN^{1/16}



226773
CUILLÈRE DE TABLE
TABLE/ PASTA SPOON
CUCHARA DE MESA
21,8 CM - 8 IN^{3/16}



226775
CUILLÈRE À CAFÉ
COFFEE/TEA SPOON
CUCHARA DE CAFÉ
15,2 CM - 6 IN

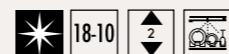

©Patrick ROUGEREAU

DEGRÈNE

PIÈCES COMPLÉMENTAIRES

PETIT GOURMET



190018
CUILLÈRE À SODA
ICED TEA SPOON
CUCHARA DE SODA/HELADO
19 CM - 7 IN^{1/2}



189973
CUILLÈRE À SODA
ICED TEA SPOON
CUCHARA DE SODA/HELADO
19 CM - 7 IN^{1/2}

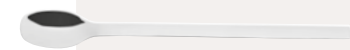

226175
CUILLÈRE À SODA
ICED TEA SPOON
CUCHARA DE SODA/HELADO
19 CM - 7 IN^{1/2}



162724
CUILLÈRE À AGRUMES
CITRUS FRUITS SPOON
CUCHARA PARA POMELO
15,3 CM - 6 IN



190424
FOURCHETTE À HUÎTRES
OYSTER FORK
TENEDOR DE OSTRAS
14,1 CM - 5 IN^{3/16}



189974
FOURCHETTE À HUÎTRES
OYSTER FORK
TENEDOR DE OSTRAS
14,1 CM - 5 IN^{3/16}



162728
**FOURCHETTE /PIQUE À
ESCARGOTS/COCKTAIL**
COCKTAIL, SNAIL FORK
TENEDOR DE CARACOLES/COCKTAIL
10,8 CM - 4 IN^{1/4}



162730
CURETTE À CRUSTACÉS
SEAFOOD SCRAPER
RASQUETA PARA CANGREJO
19,1 CM - 7 IN^{1/2}



154612
**COUTEAU À BEURRE
MONOBLOC LAME UNIE**
BUTTER KNIFE SOLID HANDLE
CUCHILLO DE MANTEQUILLA HOJA LISA
19,4 CM - 7 IN^{5/8}



189971
**COUTEAU À BEURRE
MONOBLOC LAME UNIE**
BUTTER KNIFE SOLID HANDLE
CUCHILLO DE MANTEQUILLA HOJA LISA
18,9 CM - 7 IN^{7/16}



159451
**COUTEAU À STEAK MONOBLOC
LAME SCIE**
STEAK KNIFE SOLID HANDLE SERRATED
CUCHILLO STEAK HOJA SIERRA
23,5 CM - 9 IN^{1/4}



122418
**COUTEAU À STEAK MONOBLOC
LAME SCIE**
STEAK KNIFE SOLID HANDLE SERRATED
CUCHILLO STEAK HOJA SIERRA
22,1 CM - 8 IN^{17/16}



184492
PINCE À CRUSTACÉ
SEAFOOD CRACKER
TENACILLAS PARA CRUSTÁCEOS
16,5 CM - 6 IN^{1/2}



004013
PINCE À ESCARGOTS
SNAIL TONG
PINZAS CARACOLES
16 CM - 6 IN^{5/16}



204498 + 101492
PINCE À PAIN
BREAD TONG
PINZAS PAN
23 CM - 9 IN^{1/16}



204497 + 101493
PINCE À HOMARD
LOBSTER CRACKER
TENACILLAS PARA
BOGAVANTE
18,5 CM - 7 IN^{5/16}



204496 + 101494
CISEAUX À GÂTEAUX
PASTRY CISSORS/TONG
PINZAS PARA PASTELES
20 CM - 7 IN^{7/8}



204499 + 184355
PINCE À SERVIR
SERVING TONG
PINZAS PARA SERVIR
29,5 CM - 11 IN^{5/8}



207257 + 207538
FOURCHETTE À DESSERT
DESSERT/SALAD FORK
TENEDOR DE POSTRE
16,5 CM - 6 IN^{1/2}



207259 + 207540
**COUTEAU À DESSERT
MONOBLOC LAME UNIE**
DESSERT KNIFE SOLID HANDLE
CUCHILLO DE POSTRE HOJA LISA
17,7 CM - 6 IN^{15/16}



207258 + 207539
CUILLÈRE À DESSERT
DESSERT/SOUP SPOON, OVAL
CUCHARA DE POSTRE
16,5 CM - 6 IN^{1/2}



207256 + 207537
CUILLÈRE À CAFÉ
COFFEE/TEA SPOON
CUCHARA DE CAFÉ
13,2 CM - 5 IN^{1/16}

DES LIGNES DOUCES ET UNE TAILLE ADAPTÉE AUX MAINS DES ENFANTS
POUR FAIRE DE LEUR REPAS UN MOMENT EXQUIS

SOFT LINES AND A CHILD-FRIENDLY SIZE TO MAKE CHILDREN'S
MEALTIMES A MAGIC MOMENT

LÍNEAS SUAVES Y UN TAMAÑO ADAPTADO A LAS MANOS DE LOS NIÑOS
PARA CONVERTIR LA COMIDA EN UN MOMENTO EXQUISITO



COUTEAUX À STEAK

MADE IN FRANCE

MIRAGE LES ESSENCES



NEW

233848
COUTEAU À STEAK MANCHE OLIVIER
STEAK KNIFE OLIVE WOOD HANDLE
CUCHILLO STEAK MANGO DE MADERA DE OLIVO
23 CM - 9 IN^{17/16}



NEW

233853
COUTEAU À STEAK MANCHE PICANA
STEAK KNIFE PICANA HANDLE
CUCHILLO STEAK MANGO DE PICANA
23 CM - 9 IN^{17/16}



NEW

233851
COUTEAU À STEAK MANCHE ÉBÈNE
STEAK KNIFE EBONY HANDLE
CUCHILLO STEAK MANGO DE ÉBANO
23 CM - 9 IN^{17/16}

MIRAGE



226261
COUTEAU DE TABLE/ STEAK LAME UNIE ANTHRACITE
BLACK TABLE STEAK KNIFE
CUCHILLO STEAK NEGRO
23 CM - 9 IN^{17/16}



226263
COUTEAU DE TABLE/ STEAK LAME UNIE BLANC
WHITE TABLE STEAK KNIFE
CUCHILLO STEAK BLANCO
23 CM - 9 IN^{17/16}

LAGUIOLE



232249
COUTEAU LAGUIOLE - CORNE NOIRE - MITRE INOX
LAGUIOLE STEAK KNIFE BLACK HORN - STEEL BOLSTER
LAGUIOLE CUCHILLO STEAK CUERNO - MITRA ACERO
23 CM - 9 IN^{17/16}



232251
COUTEAU LAGUIOLE - CORNE CLAIRE - MITRE LAITON
LAGUIOLE STEAK KNIFE LIGHT HORN - BRASS BOLSTER
LAGUIOLE CUCHILLO STEAK CUERNO CLARO - MITRA LATON
23 CM - 9 IN^{17/16}



232253
COUTEAU LAGUIOLE - IVOIRINE - MITRE INOX
LAGUIOLE STEAK KNIFE IVORY COLOR - STEEL BOLSTER
LAGUIOLE CUCHILLO STEAK COLOR MARFIL - MITRA ACERO
23 CM - 9 IN^{17/16}



232255
COUTEAU LAGUIOLE - OLIVIER - MITRE LAITON
LAGUIOLE STEAK KNIFE OLIVE WOOD - BRASS BOLSTER
LAGUIOLE CUCHILLO STEAK OLIVO - MITRA LATON
23 CM - 9 IN^{17/16}

CAPUCIN



232243
COUTEAU À STEAK CAPUCIN NOIR
CAPUCIN STEAK KNIFE - BLACK
CAPUCIN CUCHILLO STEAK - NEGRO
22,6 CM - 8 IN^{7/8}



232245
COUTEAU À STEAK CAPUCIN IVOIRINE
CAPUCIN STEAK KNIFE - IVORY COLOR
CAPUCIN CUCHILLO STEAK - COLOR MARFIL
22,6 CM - 8 IN^{7/8}



232247
COUTEAU À STEAK CAPUCIN ROUGE
CAPUCIN STEAK KNIFE - RED
CAPUCIN CUCHILLO STEAK - ROJO
22,6 CM - 8 IN^{7/8}



LES COUVERTS
FLATWARE - CUBIERTOS



COLLECTIONS CLASSIQUES

NORMANDY
232963 - FOURCHETTE DE TABLE - TABLE FORK - TENEDOR DE MESA P.125
232966 - COUTEAU DE TABLE MONOBLOC LAME SCIE - TABLE KNIFE SOLID HANDLE
SERRATED - CUCHILLO DE MESA HOJA SIERRA
232964 - CUIILLÈRE DE TABLE - TABLE SPOON - CUCHARA DE MESA
232965 - CUIILLÈRE À CAFÉ - COFFEE/TEA SPOON - CUCHARA DE CAFÉ



126556
FOURCHETTE DE TABLE
TABLE FORK
TENEDOR DE MESA
20,2 CM - 7 IN^{15/16}



126565
COUTEAU DE TABLE MONOCOQUE MANCHE ORFÈVRE LAME UNIE
TABLE KNIFE HOLLOW HANDLE
CUCHILLO DE MESA ENMANGADO
HOJA LISA
23 CM - 9 IN^{7/16}



130332
COUTEAU DE TABLE MONOCOQUE MANCHE ORFÈVRE LAME SCIE
TABLE KNIFE HOLLOW HANDLE SERRATED
CUCHILLO DE MESA ENMANGADO
HOJA SIERRA
23 CM - 9 IN^{7/16}



126553
CUILLÈRE DE TABLE
TABLE / PASTA SPOON
CUCHARA DE MESA
20,5 CM - 8 IN^{1/16}



126569
CUILLÈRE À DESSERT
DESSERT/SOUP SPOON, OVAL
CUCHARA DE POSTRE
18 CM - 7 IN^{7/16}



126572
FOURCHETTE À DESSERT
DESSERT/SALAD FORK
TENEDOR DE POSTRE
18 CM - 7 IN^{7/16}



126575
COUTEAU À DESSERT MONOCOQUE MANCHE ORFÈVRE LAME UNIE
DESSERT KNIFE HOLLOW HANDLE
CUCHILLO DE POSTRE ENMANGADO
HOJA LISA
20,5 CM - 8 IN^{1/16}



154528
COUTEAU À BEURRE MONOCOQUE MANCHE ORFÈVRE LAME UNIE
BUTTER KNIFE HOLLOW HANDLE
CUCHILLO DE MANTEQUILLA
ENMANGADO HOJA LISA
18,8 CM - 7 IN^{3/8}



126578
FOURCHETTE À POISSON
FISH FORK
TENEDOR DE PESCADO
18 CM - 7 IN^{7/16}



126581
COUTEAU À POISSON
FISH KNIFE
CUCHILLO DE PESCADO
20,1 CM - 7 IN^{15/16}



126559
CUILLÈRE À CAFÉ
COFFEE/TEA SPOON
CUCHARA DE CAFÉ
13,9 CM - 5 IN^{1/2}



155452
CUILLÈRE À MOKA
DEMI TASSE SPOON
CUCHARA DE MOKA
11,1 CM - 4 IN^{3/8}



126591
FOURCHETTE DE SERVICE
SERVING FORK
TENEDOR DE SERVICIO/ENSALADA
24,8 CM - 9 IN^{3/4}



126589
CUILLÈRE DE SERVICE
SERVING SPOON
CUCHARA DE SERVICIO/ENSALADA
25 CM - 9 IN^{13/16}















126587
PELLE À TARTE MANCHE ORFÈVRE
PASTRY SERVER HOLLOW HANDLE
PALA PARA TARTA ENMANGADO
24 CM - 9 IN^{7/16}



126595
LOUCHE À SAUCE
SAUCE LADLE
CAZO PARA SALSA
17 CM - 6 IN^{1/16}





	232963 FOURCHETTE DE TABLE TABLE FORK TENEDOR DE MESA 20,3 CM - 8 IN
	232966 COUTEAU DE TABLE MONOBLOC LAME SCIE TABLE KNIFE SOLID HANDLE SERRATED CUCHILLO DE MESA HOJA SIERRA 24 CM - 9 IN ^{7/8}
	232964 CUILLÈRE DE TABLE TABLE SPOON CUCHARA DE MESA 20,3 CM - 8 IN
	234654 CUILLÈRE À SOUPE ANGLAISE BOUILLON SPOON CUCHARA DE CONSOMÉ 17,6 CM - 6 IN ^{5/16}
	234659 CUILLÈRE À DESSERT DESSERT SPOON CUCHARA DE POSTRE 18,2 CM - 7 IN ^{3/16}
	234655 CUILLÈRE GOURMET GOURMET SPOON CUCHARA GOURMET 18,2 CM - 7 IN ^{3/16}
	234656 FOURCHETTE À DESSERT DESSERT FORK TENEDOR DE POSTRE 18,3 CM - 7 IN ^{3/16}
	234657 COUTEAU À DESSERT MONOBLOC LAME UNIE DESSERT KNIFE SOLID HANDLE CUCHILLO DE POSTRE 21,5 CM - 8 IN ^{7/16}
	234658 COUTEAU À BEURRE MONOBLOC LAME UNIE BUTTER KNIFE SOLID HANDLE CUCHILLO MANTEQUILLA HOJA LISA 18,5 CM - 7 IN ^{5/16}
	232965 CUILLÈRE À CAFÉ COFFEE/TEA SPOON CUCHARA DE CAFÉ 14 CM - 5 IN ^{1/2}
	234660 CUILLÈRE À MOKA DEMI TASSE SPOON CUCHARA DE MOKA 11,1 CM - 4 IN ^{3/8}
	234661 FOURCHETTE À GÂTEAUX/ COCKTAIL PASTRY/COCKTAIL FORK TENEDOR DE PASTEL 14 CM - 5 IN ^{1/2}

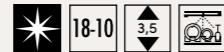

©Patrick ROUGEREAU





205533
FOURCHETTE DE TABLE
TABLE FORK
TENEDOR DE MESA
20,7 CM - 8 IN^{1/8}



199160
COUTEAU DE TABLE MONOCOQUE MANCHE ORFÈVRE LAME SCIE
TABLE KNIFE HOLLOW HANDLE SERRATED
CUCHILLO DE MESA ENMANGADO HOJA SIERRA
23,3 CM - 9 IN^{3/16}



215601
COUTEAU DE TABLE MONOCOQUE MANCHE ORFÈVRE LAME SCIE RONDE
TABLE KNIFE HOLLOW HANDLE SERRATED ROUNDED BLADE
CUCHILLO DE MESA ENMANGADO REDONDA HOJA SIERRA
23,3 CM - 9 IN^{3/16}



205534
CUILLÈRE DE TABLE
TABLE/ PASTA SPOON
CUCHARA DE MESA
20,7 CM - 8 IN^{1/8}



205535
CUILLÈRE À SOUPE ANGLAISE
BOUILLON SPOON, ROUND
CUCHARA DE CONSOMÉ
17,7 CM - 6 IN^{15/16}



205539
CUILLÈRE À DESSERT
DESSERT/SOUP SPOON, OVAL
CUCHARA DE POSTRE
18,2 CM - 7 IN^{3/16}



205538
FOURCHETTE À DESSERT
DESSERT/SALAD FORK
TENEDOR DE POSTRE
18,2 CM - 7 IN^{3/16}



199164
COUTEAU À DESSERT MONOCOQUE MANCHE ORFÈVRE LAME UNIE
DESSERT KNIFE HOLLOW HANDLE CUCHILLO DE POSTRE ENMANGADO HOJA LISA
20,6 CM - 8 IN^{1/8}



215602
COUTEAU À DESSERT MANCHE ORFÈVRE LAME UNIE RONDE
DESSERT KNIFE HOLLOW HANDLE ROUNDED BLADE CUCHILLO DE POSTRE ENMANGADO REDONDA HOJA LISA
20,6 CM - 8 IN^{1/8}



199170
COUTEAU À BEURRE MONOCOQUE MANCHE ORFÈVRE LAME UNIE
BUTTER KNIFE HOLLOW HANDLE CUCHILLO DE MANTEQUILLA ENMANGADO HOJA LISA
18,5 CM - 7 IN^{5/16}



205538
FOURCHETTE À POISSON
FISH FORK
TENEDOR DE PESCADO
18,2 CM - 7 IN^{3/16}



205537
COUTEAU À POISSON
FISH KNIFE
CUCHILLO DE PESCADO
21,2 CM - 8 IN^{5/16}



199159
CUILLÈRE À CAFÉ
COFFEE/TEA SPOON
CUCHARA DE CAFÉ
14,1 CM - 5 IN^{9/16}



199161
CUILLÈRE À MOKA
DEMI TASSE SPOON
CUCHARA DE MOKA
11,2 CM - 4 IN^{7/16}



199169
CUILLÈRE À SODA
ICED TEA SPOON
CUCHARA DE SODA/HELADO
18,8 CM - 7 IN^{3/8}



199167
FOURCHETTE À GÂTEAUX
PASTRY FORK
TENEDOR DE PASTEL
14,2 CM - 5 IN^{9/16}



199172
FOURCHETTE DE SERVICE
SERVING FORK
TENEDOR DE SERVICIO/ENSALADA
25 CM - 9 IN^{13/16}



199171
CUILLÈRE DE SERVICE
SERVING SPOON
CUCHARA DE SERVICIO/ENSALADA
25 CM - 9 IN^{13/16}



199173
PELLE À TARTE MONOBLOC
PASTRY SERVER SOLID HANDLE PALA PARA TARTA
23,9 CM - 9 IN^{7/16}



199174
LOUCHE
SOUP LADLE
CAZO
30,2 CM - 11 IN^{7/8}

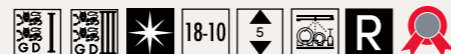

FLORENCIA

LES COUVERTS
FLATWARE - CUBIERTOS



DEGRENE



©Patrick ROUGEREAU

126077
FOURCHETTE DE TABLE
TABLE FORK
TENEDOR DE MESA
20,8 CM - 8 IN^{3/16}



190643
COUTEAU DE TABLE MONOBLOC LOURD MANCHE DROIT LAME SCIE
TABLE KNIFE SOLID HANDLE SERRATED
CUCHILLO DE MESA PESADO
RECTO MANGO HOJA SIERRA
24,6 CM - 9 IN^{17/16}



130140
COUTEAU DE TABLE MONOCOQUE MANCHE ORFÈVRE DROIT LAME SCIE
TABLE KNIFE HOLLOW HANDLE SERRATED
CUCHILLO DE MESA ENMANGADO RECTO
MANGO HOJA SIERRA
24,6 CM - 9 IN^{17/16}



127654
COUTEAU À STEAK MONOCOQUE MANCHE ORFÈVRE DROIT LAME SCIE
STEAK KNIFE HOLLOW HANDLE SERRATED
CUCHILLO DE STEAK ENMANGADO
HOJA SIERRA
23,9 CM - 9 IN^{7/16}



126074
CUILLÈRE DE TABLE
TABLE/ PASTA SPOON
CUCHARA DE MESA
20,8 CM - 8 IN^{3/16}



127651
CUILLÈRE À SOUPE ANGLAISE
BOUILLON SPOON, ROUND
CUCHARA DE CONSOMÉ
17,4 CM - 6 IN^{7/8}



126090
CUILLÈRE À DESSERT
DESSERT/SOUP SPOON, OVAL
CUCHARA DE POSTRE
18 CM - 7 IN^{1/16}



126093
FOURCHETTE À DESSERT
DESSERT/SALAD FORK
TENEDOR DE POSTRE
17,8 CM - 7 IN



190644
COUTEAU À DESSERT MONOBLOC LOURD MANCHE DROIT LAME SCIE
DESSERT KNIFE SOLID HANDLE SERRATED
CUCHILLO DE POSTRE PESADO
RECTO MANGO HOJA SIERRA
20,5 CM - 8 IN^{1/16}



126096
COUTEAU À DESSERT MONOCOQUE MANCHE ORFÈVRE LAME UNIE
DESSERT KNIFE HOLLOW HANDLE
CUCHILLO DE POSTRE RECTO MANGO
ENMANGADO HOJA LISA
20,5 CM - 8 IN^{1/16}



190417
COUTEAU À BEURRE MONOBLOC LOURD MANCHE DROIT LAME UNIE
BUTTER KNIFE SOLID HANDLE
CUCHILLO DE MANTEQUILLA PESADO
RECTO MANGO HOJA LISA
18,7 CM - 7 IN^{3/8}



129344
COUTEAU À BEURRE MONOCOQUE MANCHE DROIT LAME UNIE
BUTTER KNIFE SOLID HANDLE
CUCHILLO DE MANTEQUILLA
ENMANGADO HOJA LISA
18,7 CM - 7 IN^{3/8}



126099
FOURCHETTE À POISSON
FISH FORK
TENEDOR DE PESCADO
17,7 CM - 6 IN^{5/16}



126102
COUTEAU À POISSON
FISH KNIFE
CUCHILLO DE PESCADO
19,9 CM - 7 IN^{13/16}



129958
CUILLÈRE À SAUCE GOURMET
GOURMET/SAUCE SPOON
CUCHARA PARA SALSA
17,9 CM - 7 IN^{17/16}



126080
CUILLÈRE À CAFÉ
COFFEE/TEA SPOON
CUCHARA DE CAFÉ
14 CM - 5 IN^{1/2}



126105
CUILLÈRE À MOKA
DEMI TASSE SPOON
CUCHARA DE MOKA
11 CM - 4 IN^{5/16}



130146
CUILLÈRE À SODA
ICED TEA SPOON
CUCHARA DE SODA/HELADO
18,2 CM - 7 IN^{3/16}



126108
FOURCHETTE À GÂTEAUX/ COCKTAIL
PASTRY/COCKTAIL FORK
TENEDOR DE PASTEL
13,8 CM - 5 IN^{7/16}



190418
FOURCHETTE À HUITRES
OYSTER FORK
TENEDOR DE OSTRAS
13 CM - 5 IN^{1/8}



PIECES DE SERVICE
SERVING PIECES
SET SERVICIO
VERLAINE
P.138-139

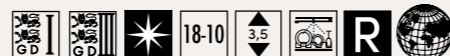



182968
FOURCHETTE DE TABLE
TABLE FORK
TENEDOR DE MESA
20,8 CM - 8 IN^{3/16}



186279
**COUTEAU À BEURRE
MONOCOQUE MANCHE
ORFÈVRE LAME UNIE**
BUTTER KNIFE HOLLOW HANDLE
CUCHILLO DE MANTEQUILLA
ENMANGADO HOJA LISA
18,7 CM - 7 IN^{3/8}



182972
FOURCHETTE À POISSON
FISH FORK
TENEDOR DE PESCADO
17,7 CM - 6 IN^{5/16}



182973
COUTEAU À POISSON
FISH KNIFE
CUCHILLO DE PESCADO
19,9 CM - 7 IN^{3/16}



186277
**CUILLÈRE À SAUCE
GOURMET**
GOURMET/SAUCE SPOON
CUCHARA PARA SALSA
17,9 CM - 7 IN^{1/16}



182969
CUILLÈRE À CAFÉ
COFFEE/TEA SPOON
CUCHARA DE CAFÉ
14 CM - 5 IN^{1/2}



182976
CUILLÈRE À MOKA
DEMI TASSE SPOON
CUCHARA DE MOKA
11 CM - 4 IN^{5/16}



186275
CUILLÈRE À SODA
ICED TEA SPOON
CUCHARA DE SODA/HELADO
18,2 CM - 7 IN^{3/16}



186274
**FOURCHETTE À GÂTEAUX/
COCKTAIL**
PASTRY/COCKTAIL FORK
TENEDOR DE PASTEL
13,8 CM - 5 IN^{7/16}



190681
FOURCHETTE À HUÎTRES
OYSTER FORK
TENEDOR DE OSTRAS
13 CM - 5 IN^{1/8}



183803
FOURCHETTE DE SERVICE
SERVING FORK
TENEDOR DE SERVICIO/ENSALADA
24,8 CM - 9 IN^{3/4}



183802
CUILLÈRE DE SERVICE
SERVING SPOON
CUCHARA DE SERVICIO/ENSALADA
25 CM - 9 IN^{13/16}



182970
**COUTEAU DE TABLE
MONOCOQUE MANCHE
ORFÈVRE LAME SCIE**
TABLE KNIFE HOLLOW HANDLE SERRATED
CUCHILLO DE MESA ENMANGADO
HOJA SIERRA
24,6 CM - 9 IN^{11/16}



186278
**COUTEAU À STEAK
MONOCOQUE MANCHE
ORFÈVRE LAME SCIE**
STEAK KNIFE HOLLOW HANDLE SERRATED
CUCHILLO DE STEAK ENMANGADO
HOJA SIERRA
23,9 CM - 9 IN^{7/16}



182967
CUILLÈRE DE TABLE
TABLE/PASTA SPOON
CUCHARA DE MESA
20,8 CM - 8 IN^{3/16}



186276
CUILLÈRE À SOUPE ANGLAISE
BOUILLON SPOON, ROUND
CUCHARA DE CONSOMÉ
17,4 CM - 6 IN^{7/8}



182974
CUILLÈRE À DESSERT
DESSERT/SOUP SPOON, OVAL
CUCHARA DE POSTRE
18 CM - 7 IN^{1/16}



182975
FOURCHETTE À DESSERT
DESSERT/SALAD FORK
TENEDOR DE POSTRE
17,8 CM - 7 IN



182971
**COUTEAU À DESSERT
MONOCOQUE MANCHE
ORFÈVRE LAME UNIE**
DESSERT KNIFE HOLLOW HANDLE
CUCHILLO DE POSTRE
ENMANGADO HOJA LISA
20,5 CM - 8 IN^{1/16}



L'ABUS D'ALCOOL EST DANGEREUX POUR LA SANTÉ
DEGRENNE PROMOTES RESPONSIBLE DRINKING AND DISCOURAGES ALCOHOL MISUSE
EL ABUSO DE ALCOHOL ES PELIGROSO PARA LA SALUD

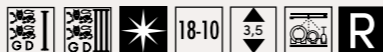



127442
FOURCHETTE DE TABLE
TABLE FORK
TENEDOR DE MESA
20,8 CM - 8 IN^{3/16}



226578
COUTEAU DE TABLE MONOBLOC LOURD LAME SCIE
TABLE KNIFE SOLID HANDLE SERRATED
CUCHILLO DE MESA PESADO
HOJA SIERRA
24,6 CM - 9 IN^{17/16}



139158
COUTEAU DE TABLE MONOCOQUE MANCHE ORFÈVRE LAME SCIE
TABLE KNIFE HOLLOW HANDLE SERRATED
CUCHILLO DE MESA ENMANGADO
HOJA SIERRA
24,6 CM - 9 IN^{17/16}



128841
COUTEAU À STEAK MONOCOQUE MANCHE ORFÈVRE LAME SCIE
STEAK KNIFE HOLLOW HANDLE SERRATED
CUCHILLO DE STEAK ENMANGADO
HOJA SIERRA
23,9 CM - 9 IN^{7/16}



127439
CUILLÈRE DE TABLE
TABLE/ PASTA SPOON
CUCHARA DE MESA
20,8 CM - 8 IN^{3/16}



130273
CUILLÈRE À SOUPE ANGLAISE
BOUILLON SPOON, ROUND
CUCHARA DE CONSOMÉ
17,4 CM - 6 IN^{7/8}



127464
CUILLÈRE À DESSERT
DESSERT/SOUP SPOON, OVAL
CUCHARA DE POSTRE
18 CM - 7 IN^{1/16}



127467
FOURCHETTE À DESSERT
DESSERT/SALAD FORK
TENEDOR DE POSTRE
17,8 CM - 7 IN



226579
COUTEAU À DESSERT MONOBLOC LOURD LAME UNIE
DESSERT KNIFE SOLID HANDLE
CUCHILLO DE POSTRE PESADO
HOJA LISA
21,1 CM - 8 IN^{5/16}



127470
COUTEAU À DESSERT MONOCOQUE MANCHE ORFÈVRE LAME UNIE
DESSERT KNIFE HOLLOW HANDLE
CUCHILLO DE POSTRE
ENMANGADO HOJA LISA
20,5 CM - 8 IN^{1/16}



226580
COUTEAU À BEURRE MONOBLOC LOURD LAME UNIE
BUTTER KNIFE HEAVY SOLID HANDLE
CUCHILLO DE MANTEQUILLA
PESADO HOJA LISA
19 CM - 7 IN^{1/2}



122769
COUTEAU À BEURRE MONOCOQUE MANCHE ORFÈVRE LAME UNIE
BUTTER KNIFE HOLLOW HANDLE
CUCHILLO DE MANTEQUILLA
ENMANGADO HOJA LISA
18,7 CM - 7 IN^{3/8}



127473
FOURCHETTE À POISSON
FISH FORK
TENEDOR DE PESCADO
17,7 CM - 6 IN^{5/16}



127477
COUTEAU À POISSON
FISH KNIFE
CUCHILLO DE PESCADO
19,9 CM - 7 IN^{13/16}



130542
CUILLÈRE À SAUCE GOURMET
GOURMET SPOON
CUCHARA PARA SALSA
17,9 CM - 7 IN^{7/16}



127455
CUILLÈRE À CAFÉ
COFFEE/TEA SPOON
CUCHARA DE CAFÉ
14 CM - 5 IN^{1/2}



127479
CUILLÈRE À MOKA
DEMI TASSE SPOON
CUCHARA DE MOKA
11 CM - 4 IN^{5/16}



127482
FOURCHETTE À GÂTEAUX/ COCKTAIL
PASTRY/COCKTAIL FORK
TENEDOR DE PASTEL
13,8 CM - 5 IN^{7/16}



130266
FOURCHETTE À HUÎTRES
OYSTER FORK
TENEDOR DE OSTRAS
13 CM - 5 IN^{1/8}

PIECES DE SERVICE
SERVING PIECES
SET SERVICIO
VERLAINE
P.138-139

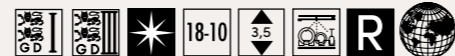

©Patrick ROUGEREAU



105278
FOURCHETTE DE TABLE
TABLE FORK
TENEDOR DE MESA
20,8 CM - 8 IN^{3/16}



105274
COUTEAU DE TABLE
MONOCOQUE MANCHE ORFÈVRE
LAME SCIE
TABLE KNIFE HOLLOW HANDLE SERRATED
CUCHILLO DE MESA ENMANGADO
HOJA SIERRA
24,6 CM - 9 IN^{17/16}



105310
CUILLÈRE DE TABLE
TABLE / PASTA SPOON
CUCHARA DE MESA
20,8 CM - 8 IN^{3/16}



105294
CUILLÈRE À DESSERT
DESSERT/SOUP SPOON, OVAL
CUCHARA DE POSTRE
18 CM - 7 IN^{11/16}



105290
FOURCHETTE À DESSERT
DESSERT/SALAD FORK
TENEDOR DE POSTRE
17,8 CM - 7 IN



105305
COUTEAU À DESSERT
MONOCOQUE MANCHE
ORFÈVRE LAME UNIE
DESSERT KNIFE HOLLOW HANDLE
CUCHILLO DE POSTRE ENMANGADO
HOJA LISA
20,5 CM - 8 IN^{17/16}



105303
CUILLÈRE À CAFÉ
COFFEE/TEA SPOON
CUCHARA DE CAFÉ
14 CM - 5 IN^{1/2}



105293
CUILLÈRE À MOKA
DEMI TASSE SPOON
CUCHARA DE MOKA
11 CM - 4 IN^{5/16}



©Patrick ROUGEREAU



105831
FOURCHETTE DE TABLE
TABLE FORK
TENEDOR DE MESA
20,8 CM - 8 IN^{3/16}



182460
COUTEAU DE TABLE MONOBLOC LOURD LAME SCIE
TABLE KNIFE HEAVY SOLID HANDLE SERRATED
CUCHILLO DE MESA PESADO HOJA SIERRA
24,6 CM - 9 IN^{1/16}



105886
COUTEAU DE TABLE MONOCOQUE MANCHE ORFÈVRE LAME UNIE
TABLE KNIFE HOLLOW HANDLE CUCHILLO DE MESA ENMANGADO HOJA LISA
24,6 CM - 9 IN^{1/16}



105860
COUTEAU DE TABLE MONOCOQUE MANCHE ORFÈVRE LAME SCIE
TABLE KNIFE HOLLOW HANDLE SERRATED CUCHILLO DE MESA ENMANGADO HOJA SIERRA
24,6 CM - 9 IN^{1/16}



105801
COUTEAU À STEAK MONOCOQUE MANCHE ORFÈVRE LAME SCIE
STEAK KNIFE HOLLOW HANDLE SERRATED CUCHILLO DE STEAK ENMANGADO HOJA SIERRA
23,9 CM - 9 IN^{7/16}



105798
CUILLÈRE DE TABLE
TABLE/PASTA SPOON
CUCHARA DE MESA
20,8 CM - 8 IN^{3/16}



112692
CUILLÈRE À SOUPE ANGLAISE
BOUILLON SPOON, ROUND
CUCHARA DE CONSOMÉ
17,2 CM - 6 IN^{3/4}



105861
CUILLÈRE À DESSERT
DESSERT/SOUP SPOON, OVAL
CUCHARA DE POSTRE
18 CM - 7 IN^{1/16}



105885
FOURCHETTE À DESSERT
DESSERT/SALAD FORK
TENEDOR DE POSTRE
17,8 CM - 7 IN



182463
COUTEAU À DESSERT MONOBLOC LOURD LAME UNIE
DESSERT KNIFE HEAVY SOLID HANDLE CUCHILLO DE POSTRE PESADO HOJA LISA
21,1 CM - 8 IN^{5/16}



105832
COUTEAU À DESSERT MONOCOQUE MANCHE ORFÈVRE LAME UNIE
DESSERT KNIFE HOLLOW HANDLE CUCHILLO DE POSTRE ENMANGADO HOJA LISA
20,5 CM - 8 IN^{1/16}



190420
COUTEAU À BEURRE MONOBLOC LOURD LAME UNIE
BUTTER KNIFE HEAVY SOLID HANDLE CUCHILLO DE MANTEQUILLA PESADO HOJA LISA
19 CM - 7 IN^{1/2}



003332
COUTEAU À BEURRE MONOCOQUE MANCHE ORFÈVRE LAME UNIE
BUTTER KNIFE HOLLOW HANDLE CUCHILLO DE MANTEQUILLA ENMANGADO HOJA LISA
18,7 CM - 7 IN^{3/8}



108918
FOURCHETTE À POISSON
FISH FORK
TENEDOR DE PESCADO
17,8 CM - 7 IN



108920
COUTEAU À POISSON
FISH KNIFE
CUCHILLO DE PESCADO
19,7 CM - 7 IN^{3/4}



105910
CUILLÈRE À SAUCE GOURMET
GOURMET/SAUCE SPOON
CUCHARA PARA SALSA
17,9 CM - 7 IN^{1/16}



105833
CUILLÈRE À CAFÉ
COFFEE/TEA SPOON
CUCHARA DE CAFÉ
14 CM - 5 IN^{1/2}



105906
CUILLÈRE À MOKA
DEMI TASSE SPOON
CUCHARA DE MOKA
11 CM - 4 IN^{5/16}



105800
CUILLÈRE À SODA
ICED TEA SPOON
CUCHARA DE SODA/HELADO
18,2 CM - 7 IN^{3/16}



105795
FOURCHETTE À GÂTEAUX/ COCKTAIL
PASTRY/COCKTAIL FORK
TENEDOR DE PASTEL
13,8 CM - 5 IN^{7/16}

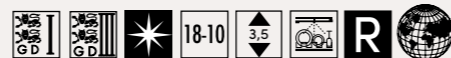



123440
FOURCHETTE À HUITRES
OYSTER FORK
TENEDOR DE OSTRAS
12,9 CM - 5 IN^{17/16}



132782
FOURCHETTE À ESCARGOTS
SNAIL FORK
TENEDOR DE CARACOLES
13,5 CM - 5 IN^{5/16}



130994
CUILLÈRE À TOASTS
APPETIZER SPOON
CUCHARA PARA APERITIVO
11,8 CM - 7 IN^{27/16}



003390
**COUTEAU À FROMAGES
MONOCOQUE MANCHE
ORFÈVRE LAME UNIE**
CHEESE KNIFE HOLLOW HANDLE
CUCHILLO DE QUESO ENMANGADO
19,3 CM - 7 IN^{5/8}



002185
FOURCHETTE DE SERVICE
SERVING FORK
TENEDOR DE SERVICIO/ENSALADA
24,8 CM - 9 IN^{3/4}



002186
CUILLÈRE DE SERVICE
SERVING SPOON
CUCHARA DE SERVICIO/ENSALADA
25 CM - 9 IN^{13/16}



040646
SERVICE À SALADE
SALAD SERVING SET
SET SERVICIO DE ENSALADA
25,8 CM - 10 IN^{37/16}



083340
**PELLE À TARTE
MONOBLOC**
PASTRY SERVER SOLID HANDLE
PALA PARA TARTA
24,9 CM - 9 IN^{13/16}



097717
LOUCHE
SOUP LADLE
CAZO
29,8 CM - 11 IN^{3/4}



002179
LOUCHE À SAUCE
SAUCE LADLE
CAZO PARA SALSAS
15,7 CM - 6 IN^{3/16}



002191
PINCE À SUCRE
SUGAR TONG
PINZA PARA AZÚCAR
11,5 CM - 4 IN^{1/2}

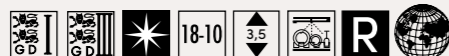

©Patrick ROUGÉREAU





105021
FOURCHETTE DE TABLE
TABLE FORK
TENEDOR DE MESA
20,9 CM - 8 IN^{3/16}



190415
COUTEAU DE TABLE MONOBLOC LOURD
LAME SCIE
TABLE KNIFE SOLID HANDLE SERRATED
CUCHILLO DE MESA PESADO
HOJA SIERRA
24,8 CM - 9 IN^{3/4}



105006
COUTEAU DE TABLE MONOCOQUE MANCHE
ORFÈVRE LAME SCIE
TABLE KNIFE HOLLOW HANDLE SERRATED
CUCHILLO DE MESA ENMANGADO
HOJA SIERRA
24,7 CM - 9 IN^{3/4}



122746
COUTEAU À STEAK MONOCOQUE MANCHE
ORFÈVRE LAME SCIE
STEAK KNIFE HOLLOW HANDLE SERRATED
CUCHILLO DE STEAK ENMANGADO
HOJA SIERRA
23,8 CM - 9 IN^{3/8}



104988
CUILLÈRE DE TABLE
TABLE/ PASTA SPOON
CUCHARA DE MESA
21,1 CM - 8 IN^{5/16}



104975
CUILLÈRE À SOUPE ANGLAISE
BOUILLON SPOON, ROUND
CUCHARA DE CONSOMÉ
17,4 CM - 6 IN^{7/8}



104985
CUILLÈRE À DESSERT
DESSERT/SOUP SPOON, OVAL
CUCHARA DE POSTRE
18 CM - 7 IN^{1/16}



105013
FOURCHETTE À DESSERT
DESSERT/SALAD FORK
TENEDOR DE POSTRE
17,9 CM - 7 IN^{1/8}



190416
COUTEAU À DESSERT MONOBLOC LOURD
LAME UNIE
DESSERT KNIFE SOLID HANDLE
CUCHILLO DE POSTRE PESADO
HOJA LISA
21,3 CM - 8 IN^{3/8}



104989
COUTEAU À DESSERT MONOCOQUE MANCHE
ORFÈVRE LAME UNIE
DESSERT KNIFE HOLLOW HANDLE
CUCHILLO DE POSTRE
ENMANGADO HOJA LISA
20,6 CM - 8 IN^{1/8}



190414
COUTEAU À BEURRE MONOBLOC LOURD
LAME UNIE
BUTTER KNIFE SOLID HANDLE
CUCHILLO DE MANTEQUILLA
PESADO HOJA LISA
19,7 CM - 7 IN^{3/4}



016394
COUTEAU À BEURRE MONOCOQUE MANCHE
ORFÈVRE LAME UNIE
BUTTER KNIFE HOLLOW HANDLE
CUCHILLO DE MANTEQUILLA
ENMANGADO HOJA LISA
18,9 CM - 7 IN^{7/16}



104994
FOURCHETTE À POISSON
FISH FORK
TENEDOR DE PESCADO
17,9 CM - 7 IN^{1/16}



104995
COUTEAU À POISSON
FISH KNIFE
CUCHILLO DE PESCADO
20 CM - 7 IN^{7/8}



104977
CUILLÈRE À SAUCE GOURMET
GOURMET/SAUCE SPOON
CUCHARA PARA SALSA
18 CM - 7 IN^{1/16}



104986
CUILLÈRE À CAFÉ
COFFEE/TEA SPOON
CUCHARA DE CAFÉ
14,1 CM - 5 IN^{37/16}



104993
CUILLÈRE À MOKA
DEMI TASSE SPOON
CUCHARA DE MOKA
11,2 CM - 4 IN^{1/16}



105012
FOURCHETTE À GÂTEAUX/ COCKTAIL
PASTRY/COCKTAIL FORK
TENEDOR DE PASTEL
13,9 CM - 5 IN^{1/2}



LES COUVERTS
FLATWARE - CUBIERTOS





104485
FOURCHETTE DE TABLE
TABLE FORK
TENEDOR DE MESA
20,8 CM - 8 IN^{3/16}



182466
COUTEAU DE TABLE MONOBLOC LOURD LAME SCIE
TABLE KNIFE HEAVY SOLID HANDLE SERRATED
CUCHILLO DE MESA PESADO SIERRA
24,6 CM - 9 IN^{1/16}



161390
COUTEAU DE TABLE MONOCOQUE MANCHE ORFÈVRE LAME UNIE
TABLE KNIFE HOLLOW HANDLE
CUCHILLO DE MESA ENMANGADO HOJA LISA
24,6 CM - 9 IN^{1/16}



161391
COUTEAU DE TABLE MONOCOQUE MANCHE ORFÈVRE LAME SCIE
TABLE KNIFE HOLLOW HANDLE SERRATED
CUCHILLO DE MESA ENMANGADO HOJA SIERRA
24,6 CM - 9 IN^{1/16}



122759
COUTEAU À STEAK MONOCOQUE MANCHE ORFÈVRE LAME SCIE
STEAK KNIFE HOLLOW HANDLE SERRATED
CUCHILLO DE STEAK ENMANGADO HOJA SIERRA
23,9 CM - 9 IN^{7/16}



104526
CUILLÈRE DE TABLE
TABLE/PASTA SPOON
CUCHARA DE MESA
20,8 CM - 8 IN^{3/16}



112695
CUILLÈRE À SOUPE ANGLAISE
BOUILLON SPOON, ROUND
CUCHARA DE CONSOMÉ
17,2 CM - 6 IN^{3/4}



104484
CUILLÈRE À DESSERT
DESSERT/SOUP SPOON, OVAL
CUCHARA DE POSTRE
18 CM - 7 IN^{1/16}



104543
FOURCHETTE À DESSERT
DESSERT/SALAD FORK
TENEDOR DE POSTRE
17,8 CM - 7 IN



182467
COUTEAU À DESSERT MONOBLOC LOURD LAME UNIE
DESSERT KNIFE HEAVY SOLID HANDLE
CUCHILLO DE POSTRE PESADO HOJA LISA
20,5 CM - 8 IN^{1/16}



161394
COUTEAU À DESSERT MONOCOQUE MANCHE ORFÈVRE LAME UNIE
DESSERT KNIFE HOLLOW HANDLE
CUCHILLO DE POSTRE ENMANGADO HOJA LISA
20,5 CM - 8 IN^{1/16}



190419
COUTEAU À BEURRE MONOBLOC LOURD LAME UNIE
BUTTER KNIFE HEAVY SOLID HANDLE
CUCHILLO DE MANTEQUILLA PESADO HOJA LISA
18,7 CM - 7 IN^{3/8}



122760
COUTEAU À BEURRE MONOCOQUE MANCHE ORFÈVRE LAME UNIE
BUTTER KNIFE HOLLOW HANDLE
CUCHILLO DE MANTEQUILLA ENMANGADO HOJA LISA
18,7 CM - 7 IN^{3/8}



108922
FOURCHETTE À POISSON
FISH FORK
TENEDOR DE PESCADO
17,8 CM - 7 IN



108924
COUTEAU À POISSON
FISH KNIFE
CUCHILLO DE PESCADO
19,7 CM - 7 IN^{3/4}



145451
CUILLÈRE À SAUCE GOURMET
GOURMET/SAUCE SPOON
CUCHARA PARA SALSA
17,9 CM - 7 IN^{1/16}



104561
CUILLÈRE À CAFÉ
COFFEE/TEA SPOON
CUCHARA DE CAFÉ
14 CM - 5 IN^{1/2}



161398
CUILLÈRE À MOKA
DEMI TASSE SPOON
CUCHARA DE MOKA
11 CM - 4 IN^{5/16}



124259
CUILLÈRE À SODA
ICED TEA SPOON
CUCHARA DE SODA/HELADO
18,2 CM - 7 IN^{3/16}



104480
FOURCHETTE À GÂTEAUX/ COCKTAIL
PASTRY/COCKTAIL FORK
TENEDOR DE PASTEL
13,8 CM - 5 IN^{7/16}





123434
FOURCHETTE À HÙITRES
OYSTER FORK
TENEDOR DE OSTRAS
12,9 CM - 5 IN^{17/16}



189208
**COUTEAU À FROMAGE
MONOCOQUE MANCHE
ORFÈVRE LAME UNIE**
CHEESE KNIFE HOLLOW HANDLE
CUCHILLO QUESO ENMANGADO
19,3 CM - 7 IN^{5/8}



195757
FOURCHETTE DE SERVICE
SERVING FORK
TENEDOR DE SERVICIO/ENSALADA
24,8 CM - 9 IN^{3/4}



195755
CUILLÈRE DE SERVICE
SERVING SPOON
CUCHARA DE SERVICIO/ENSALADA
25 CM - 9 IN^{37/16}



195757
FOURCHETTE À DÉCOUPER
CARVING FORK
TENEDOR TRINCHANTE
24,8 CM - 9 IN^{3/4}

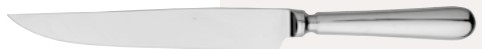

189511
**COUTEAU À DÉCOUPER
MONOCOQUE/MANCHE
ORFÈVRE LAME UNIE**
CARVING KNIFE HOLLOW HANDLE
CUCHILLO TRINCHANTE ENMANGADO
HOJA LISA
28,7 CM - 11 IN^{57/16}



195750
SERVICE À SALADE
SALAD SERVING SET
SET SERVICIO/ENSALADA
25,7 CM - 10 IN¹⁹



195753
**PELLE À TARTE
MONOBLOC**
PASTRY SERVER SOLID HANDLE
PALA PARA TARTA
24,9 CM - 9 IN^{137/16}



195762
LOUCHE
SOUP LADLE
CAZO
29,8 CM - 11 IN^{3/4}



195759
LOUCHE À SAUCE
SAUCE LADLE
CAZO PARA SALSA
15,7 CM - 6 IN^{37/16}



©Patrick ROUGEREAU



235927
FOURCHETTE DE TABLE
TABLE FORK
TENEDOR DE MESA
19,9 CM - 7 IN^{37/16}



235931
COUTEAU DE TABLE MONOBLOC LAME SCIE
TABLE KNIFE SOLID HANDLE SERRATED
CUCHILLO DE MESA HOJA SIERRA
23,2 CM - 9 IN^{17/8}



235928
CUILLÈRE DE TABLE
TABLE SPOON
CUCHARA DE MESA
19,9 CM - 7 IN^{37/16}



235938
CUILLÈRE À SOUPE ANGLAISE
BOUILLON SPOON, ROUND
CUCHARA DE CONSOMÉ
18,4 CM - 7 IN¹⁴



235934
CUILLÈRE À DESSERT
DESSERT/SOUP SPOON, OVAL
CUCHARA DE POSTRE
18,4 CM - 7 IN¹⁴



235933
FOURCHETTE À DESSERT
DESSERT/SALAD FORK
TENEDOR DE POSTRE
18,4 CM - 7 IN¹⁴



235936
COUTEAU À DESSERT MONOBLOC LAME SCIE
DESSERT KNIFE SOLID HANDLE
SERRATED
CUCHILLO DE POSTRE HOJA SIERRA
20,9 CM - 8 IN^{37/16}



235939
COUTEAU À BEURRE MONOBLOC LAME UNIE
BUTTER KNIFE SOLID HANDLE
CUCHILLO DE MANTEQUILLA HOJA LISA
16,5 CM - 6 IN^{17/2}



235929
CUILLÈRE À CAFÉ
COFFEE/TEA SPOON
CUCHARA DE CAFÉ
13,9 CM - 5 IN^{17/2}



235932
CUILLÈRE À MOKA
DEMI TASSE SPOON
CUCHARA DE MOKA
10,9 CM - 4 IN^{9/16}



235937
FOURCHETTE À COCKTAIL
COCKTAIL FORK
TENEDOR DE COCKTAIL
14,1 CM - 5 IN^{9/16}



231218
FOURCHETTE DE SERVICE
SERVING FORK
TENEDOR DE SERVICIO/ENSALADA
26,6 CM - 10 IN^{1/2}



231219
CUILLÈRE DE SERVICE
SERVING SPOON
CUCHARA DE SERVICIO/ENSALADA
26,6 CM - 10 IN^{1/2}



231221
PELLE À TARTE MONOBLOC
PASTRY SERVER SOLID HANDLE
PALA PARA TARTA
25,2 CM - 9 IN^{15/16}



231220
LOUCHE
SOUP LADLE
CAZO
29 CM - 11 IN^{27/8}



LES COUVERTS
FLATWARE - CUBIERTOS

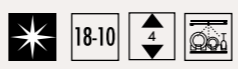























©Patrick ROUCEREAU

MIKADO MIROIR

LES COUVERTS
FLATWARE - CUBIERTOS



- | | | | |
|---|---|--|--|
|  | 141089
FOURCHETTE DE TABLE
TABLE FORK
TENEDOR DE MESA
20,3 CM - 8 IN |  | 103550
CUILLÈRE À CAFÉ
COFFEE/TEA SPOON
CUCHARA DE CAFÉ
13,5 CM - 5 IN ^{5/16} |
|  | 113017
COUTEAU DE TABLE
MONOBLOC LOURD
LAME SCIE
TABLE KNIFE SOLID HANDLE SERRATED
CUCHILLO DE MESA PESADO
HOJA SIERRA
24,4 CM - 9 IN ^{5/8} |  | 109465
CUILLÈRE À MOKA
DEMI TASSE SPOON
CUCHARA DE MOKA
11 CM - 4 IN ^{5/16} |
|  | 160427
COUTEAU À STEAK
MONOBLOC LAME SCIE
STEAK KNIFE SOLID HANDLE SERRATED
CUCHILLO DE STEAK
HOJA SIERRA
23,2 CM - 9 IN ^{5/8} |  | 124259
CUILLÈRE À SODA
ICED TEA SPOON
CUCHARA DE SODA/HELADO
18,2 CM - 7 IN ^{3/16} |
|  | 141086
CUILLÈRE DE TABLE
TABLE/ PASTA SPOON
CUCHARA DE MESA
20,4 CM - 8 IN ^{7/16} |  | 109466
FOURCHETTE À GÂTEAUX/
COCKTAIL
PASTRY/COCKTAIL FORK
TENEDOR DE PASTEL
15 CM - 5 IN ^{7/8} |
|  | 112695
CUILLÈRE À SOUPE ANGLAISE
BOUILLON SPOON, ROUND
CUCHARA DE CONSOMÉ
17,2 CM - 6 IN ^{3/4} |  | 123434
FOURCHETTE À HUÎTRES
OYSTER FORK
TENEDOR DE OSTRAS
12,9 CM - 5 IN ^{1/16} |
|  | 108236
CUILLÈRE À DESSERT
DESSERT/SOUP SPOON, OVAL
CUCHARA DE POSTRE
17,9 CM - 7 IN ^{17/16} |  | 195757
FOURCHETTE DE SERVICE
SERVING FORK
TENEDOR DE SERVICIO/ENSALADA
24,8 CM - 9 IN ^{3/4} |
|  | 108238
FOURCHETTE À DESSERT
DESSERT/SALAD FORK
TENEDOR DE POSTRE
17,8 CM - 7 IN |  | 195755
CUILLÈRE DE SERVICE
SERVING SPOON
CUCHARA DE SERVICIO/ENSALADA
25 CM - 9 IN ^{13/16} |
|  | 113019
COUTEAU À DESSERT
MONOBLOC LOURD
LAME UNIE
DESSERT KNIFE SOLID HANDLE
CUCHILLO DE POSTRE PESADO
HOJA LISA
21 CM - 8 IN ^{1/4} |  | 195750
SERVICE À SALADE
SALAD SERVING SET
SET SERVICIO/ENSALADA
25,7 CM - 10 IN ^{1/8} |
|  | 189971
COUTEAU À BEURRE
MONOBLOC
LAME UNIE
BUTTER KNIFE SOLID HANDLE
CUCHILLO DE MANTEQUILLA
HOJA LISA
18,9 CM - 7 IN ^{7/16} |  | 195753
PELLE À TARTE
MONOBLOC
PASTRY SERVER SOLID HANDLE
PALA PARA TARTA
24,9 CM - 9 IN ^{13/16} |
|  | 108922
FOURCHETTE À POISSON
FISH FORK
TENEDOR DE PESCADO
17,8 CM - 7 IN |  | 195762
LOUCHE
SOUP LADLE
CAZO
29,8 CM - 11 IN ^{3/4} |
|  | 108924
COUTEAU À POISSON
FISH KNIFE
CUCHILLO DE PESCADO
19,7 CM - 7 IN ^{3/4} |  | 195759
LOUCHE À SAUCE
SAUCE LADLE
CAZO PARA SALSAS
15,7 CM - 6 IN ^{3/16} |



©Patrick ROUGEREAU

MIKADO VINTAGE

LES COUVERTS
FLATWARE - CUBIERTOS



DEGRÈNE



230285
FOURCHETTE DE TABLE
TABLE FORK
TENEDOR DE MESA
20,3 CM - 8 IN

230287
**COUTEAU DE TABLE
MONOBLOC LOURD**
LAME SCIE
TABLE KNIFE SOLID HANDLE SERRATED
CUCHILLO DE MESA PESADO
HOJA SIERRA
24,4 CM - 9 IN^{5/8}

230293
**COUTEAU À STEAK
MONOBLOC LAME SCIE**
STEAK KNIFE SOLID HANDLE SERRATED
CUCHILLO DE STEAK
HOJA SIERRA
23,2 CM - 9 IN^{1/8}

230286
CUILLÈRE DE TABLE
TABLE / PASTA SPOON
CUCHARA DE MESA
20,4 CM - 8 IN^{1/16}

230291
CUILLÈRE À DESSERT
DESSERT/SOUP SPOON, OVAL
CUCHARA DE POSTRE
17,9 CM - 7 IN^{1/16}

230290
FOURCHETTE À DESSERT
DESSERT/SALAD FORK
TENEDOR DE POSTRE
17,8 CM - 7 IN

230292
**COUTEAU À DESSERT
MONOBLOC LOURD**
LAME UNIE
DESSERT KNIFE SOLID HANDLE
CUCHILLO DE POSTRE PESADO
HOJA LISA
21 CM - 8 IN^{1/4}

232308
**COUTEAU À BEURRE
MONOBLOC**
LAME UNIE
BUTTER KNIFE SOLID HANDLE
CUCHILLO DE MANTEQUILLA
HOJA LISA
18,9 CM - 7 IN^{7/16}

230288
CUILLÈRE À CAFÉ
COFFEE/TEA SPOON
CUCHARA DE CAFÉ
13,5 CM - 5 IN^{5/16}

230289
CUILLÈRE À MOKA
DEMI TASSE SPOON
CUCHARA DE MOKA
11 CM - 4 IN^{5/16}

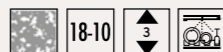

©Patrick ROUGEREAU



141094
FOURCHETTE DE TABLE
TABLE FORK
TENEDOR DE MESA
20,3 CM - 8 IN



103857
**COUTEAU DE TABLE
MONOBLOC LAME SCIE**
TABLE KNIFE SOLID HANDLE SERRATED
CUCHILLO DE MESA
HOJA SIERRA
23,7CM - 9 IN^{5/16}



160433
**COUTEAU À STEAK
MONOBLOC LAME SCIE**
STEAK KNIFE SOLID HANDLE SERRATED
CUCHILLO DE STEAK
HOJA SIERRA
23,6 CM - 9 IN^{5/16}



141092
CUILLÈRE DE TABLE
TABLE/ PASTA SPOON
CUCHARA DE MESA
20,4 CM - 8 IN^{1/8}



112692
CUILLÈRE À SOUPE ANGLAISE
BOUILLON SPOON, ROUND
CUCHARA DE CONSOMÉ
17,2 CM - 6 IN^{3/4}



108232
CUILLÈRE À DESSERT
DESSERT/SOUP SPOON, OVAL
CUCHARA DE POSTRE
17,9 CM - 7 IN^{1/16}



108234
FOURCHETTE À DESSERT
DESSERT/SALAD FORK
TENEDOR DE POSTRE
17,8 CM - 7 IN



210628
**COUTEAU À DESSERT
MONOBLOC LAME SCIE**
DESSERT KNIFE SOLID HANDLE
CUCHILLO DE POSTRE PESADO
HOJA LISA
20,6 CM - 8 IN^{1/8}



108918
FOURCHETTE À POISSON
FISH FORK
TENEDOR DE PESCADO
17,8 CM - 7 IN



108920
COUTEAU À POISSON
FISH KNIFE
CUCHILLO DE PESCADO
19,7 CM - 7 IN^{3/4}



103564
CUILLÈRE À CAFÉ
COFFEE/TEA SPOON
CUCHARA DE CAFÉ
13,5 CM - 5 IN^{5/16}



109471
CUILLÈRE À MOKA
DEMI TASSE SPOON
CUCHARA DE MOKA
11 CM - 4 IN^{5/16}



105800
CUILLÈRE À SODA
ICED TEA SPOON
CUCHARA DE SODA/HELADO
18,2 CM - 7 IN^{3/16}



109472
**FOURCHETTE À GÂTEAUX/
COCKTAIL**
PASTRY/COCKTAIL FORK
TENEDOR DE PASTEL
15 CM - 5 IN^{7/8}



123440
FOURCHETTE À HÙÎTRES
OYSTER FORK
TENEDOR DE OSTRAS
12,9 CM - 5 IN^{1/16}



132782
FOURCHETTE À ESCARGOTS
SNAIL FORK
TENEDOR DE CARACOLES
13,5 CM - 5 IN^{5/16}



002185
FOURCHETTE DE SERVICE
SERVING FORK
TENEDOR DE SERVICIO/ENSALADA
24,8 CM - 9 IN^{3/4}



002186
CUILLÈRE DE SERVICE
SERVING SPOON
CUCHARA DE SERVICIO/ENSALADA
25 CM - 9 IN^{13/16}



040646
SERVICE À SALADE
SALAD SERVING SET
SET SERVICIO DE ENSALADA
25,8 CM - 10 IN^{3/16}



083340
**PELLE À TARTE
MONOBLOC**
PASTRY SERVER SOLID HANDLE
PALA PARA TARTA
24,9 CM - 9 IN^{13/16}

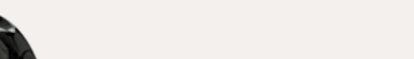

097717
LOUCHE
SOUP LADLE
CAZO
29,8 CM - 11 IN^{3/4}



002179
LOUCHE À SAUCE
SAUCE LADLE
CAZO PARA SALSAS
15,7 CM - 6 IN^{3/16}



©Patrick ROJUREAU

VIEUX PARIS SATINÉ

LES COUVERTS
FLATWARE - CUBIERTOS



105804
FOURCHETTE DE TABLE
TABLE FORK
TENEDOR DE MESA
21 CM - 8 IN^{1/4}



105837
FOURCHETTE À POISSON
FISH FORK
TENEDOR DE PESCADO
18 CM - 7 IN^{1/16}



105892
**COUTEAU DE TABLE
MONOBLOC LAME SCIE**
TABLE KNIFE SOLID HANDLE SERRATED
CUCHILLO DE MESA
HOJA SIERRA
25 CM - 9 IN^{13/16}



105912
COUTEAU À POISSON
FISH KNIFE
CUCHILLO DE PESCADO
20 CM - 7 IN^{7/8}



105864
**COUTEAU DE TABLE
MONOCOQUE MANCHE
ORFÈVRE LAME UNIE**
TABLE KNIFE HOLLOW HANDLE
CUCHILLO DE MESA ENMANGADO
HOJA LISA
24,7 CM - 9 IN^{3/4}



105838
CUILLÈRE À CAFÉ
COFFEE/TEA SPOON
CUCHARA DE CAFÉ
14,1 CM - 5 IN^{9/16}



105913
**COUTEAU DE TABLE
MONOCOQUE MANCHE
ORFÈVRE LAME SCIE**
TABLE KNIFE HOLLOW HANDLE SERRATED
CUCHILLO DE MESA ENMANGADO
HOJA SIERRA
24,7 CM - 9 IN^{3/4}



105891
CUILLÈRE À MOKA
DEMI TASSE SPOON
CUCHARA DE MOKA
11 CM - 4 IN^{5/16}



160424
**COUTEAU À STEAK
MONOBLOC LAME SCIE**
STEAK KNIFE SOLID HANDLE SERRATED
CUCHILLO DE STEAK
HOJA SIERRA
23,2 CM - 9 IN^{1/8}



105805
**FOURCHETTE À GÂTEAUX/
COCKTAIL**
PASTRY/COCKTAIL FORK
TENEDOR DE PASTEL
13,9 CM - 5 IN^{1/2}



105911
CUILLÈRE DE TABLE
TABLE/ PASTA SPOON
CUCHARA DE MESA
21 CM - 8 IN^{1/4}



105803
FOURCHETTE À HÙITRES
OYSTER FORK
TENEDOR DE OSTRAS
13,2 CM - 5 IN^{3/16}



105863
CUILLÈRE À DESSERT
DESSERT/SOUP SPOON, OVAL
CUCHARA DE POSTRE
18 CM - 7 IN^{1/16}



000490
FOURCHETTE DE SERVICE
SERVING FORK
TENEDOR DE SERVICIO/ENSALADA
24,6 CM - 9 IN^{11/16}



105890
FOURCHETTE À DESSERT
DESSERT/SALAD FORK
TENEDOR DE POSTRE
18 CM - 7 IN



000491
CUILLÈRE DE SERVICE
SERVING SPOON
CUCHARA DE SERVICIO/ENSALADA
24,9 CM - 9 IN^{13/16}



210626
**COUTEAU À DESSERT
MONOBLOC LAME SCIE**
DESSERT KNIFE SOLID HANDLE
CUCHILLO DE POSTRE PESADO
HOJA LISA
20,7 CM - 8 IN^{1/8}



105802
**COUTEAU À DESSERT
MONOCOQUE MANCHE
ORFÈVRE LAME UNIE**
DESSERT KNIFE HOLLOW HANDLE
CUCHILLO DE POSTRE ENMANGADO
HOJA LISA
20,5 CM - 8 IN^{1/16}

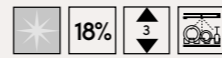



PLATERIE

A travers des objets en acier dédiés à la table, au service et à la dégustation, DEGRENNE exprime la richesse de son métier d'orfèvre. Des pièces de forme aux **lignes raffinées** jusqu'aux accessoires présentés sur la table des convives, **la collection platerie DEGRENNE s'accorde parfaitement avec l'ensemble des gammes** pour offrir un service élégant et moderne.

HOLLOWARE

DEGRENNE expresses its highly-varied metal-working expertise through steel products designed for the table, service and tasting and appreciating. From shaped pieces with **sophisticated lines** to accessories showcased on the guests' table, **DEGRENNE's holloware collection fits perfectly with all the other ranges**, making for an elegant and contemporary service.

ORFEBRERÍA

A través de los objetos de acero dedicados a la mesa, al servicio y a la degustación, DEGRENNE expresa la riqueza de su oficio de orfebre. Desde piezas de forma con **líneas refinadas** hasta accesorios presentados en la mesa de los invitados, **la colección de platería DEGRENNE combina perfectamente con el conjunto de las gamas** para ofrecer un servicio elegante y moderno.

NEWPORT
182614 - CLOCHE ASSIETTE
DOME COVER STAINLESS STEEL - CAMPANA

P.168



PLATEAUX – SERVING TRAYS – BANDEJAS

PLATEAUX EMPILABLES
STACKABLE SERVING TRAYS
APILABLES BANDEJAS



185018 + 186458
**PLATEAU RECTANGULAIRE
AVEC ANSES**
RECTANGULAR SERVING TRAYS
WITH HANDLES
BANDEJA RECTANGULAR CON ASAS
77 X 55 CM – 30 IN^{5/16} X 21 IN^{5/8}

185023 + 186459
**PLATEAU RECTANGULAIRE
AVEC ANSES GASTRONORM 2/1**
RECTANGULAR SERVING TRAYS
WITH HANDLES
BANDEJA RECTANGULAR CON ASAS
65 X 53 CM – 25 IN^{9/16} X 20 IN^{7/8}

185022 + 186460
**PLATEAU RECTANGULAIRE
AVEC ANSES**
RECTANGULAR SERVING TRAYS
WITH HANDLES
BANDEJA RECTANGULAR CON ASAS
60 X 40 CM – 23 IN^{5/8} X 15 IN^{3/4}



185021 + 186461
**PLATEAU RECTANGULAIRE
SANS ANSES GASTRONORM 1/1**
RECTANGULAR SERVING TRAYS
WITHOUT HANDLES
BANDEJA RECTANGULAR SIN ASAS
53 X 32,5 CM – 20 IN^{7/8} X 12 IN^{13/16}



185020 + 186462
**PLATEAU RECTANGULAIRE
SANS ANSES**
RECTANGULAR SERVING TRAYS
WITHOUT HANDLES
BANDEJA RECTANGULAR SIN ASAS
40 X 27 CM – 15 IN^{3/4} X 10 IN^{5/8}



185019 + 186463
**PLATEAU RECTANGULAIRE
SANS ANSES GASTRONORM 1/2**
RECTANGULAR SERVING TRAYS
WITHOUT HANDLES
BANDEJA RECTANGULAR SIN ASAS
32,5 X 26,5 CM – 12 IN^{13/16} X 10 IN^{7/16}



227767 + 227768
**PLATEAU RECTANGULAIRE
SANS ANSES**
RECTANGULAR SERVING TRAYS
WITHOUT HANDLES
BANDEJA RECTANGULAR SIN ASAS
22 X 14 CM – 8 IN^{11/16} X 5 IN^{1/2}



185024 + 186457
PLATEAU ROND
ROUND TRAY
BANDEJA REDONDA
42 CM – 16 IN^{9/16}

NORMANDY

NEW
232972 +
PLATEAU RECTANGULAIRE
RECTANGULAR SERVING TRAY
BANDEJA RECTANGULAR
26 X 18 CM – 10 IN^{1/4} X 7 IN^{17/16}



NEWPORT CUBIQUE

PLATEAUX - SERVING TRAYS - BANDEJAS

PLATEAUX EMPILABLES
STACKABLE SERVING TRAYS
APILABLES BANDEJAS

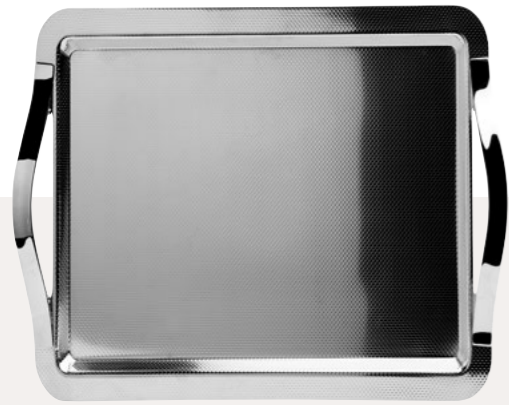

211886 + 213857
**PLATEAU RECTANGULAIRE
AVEC ANSES GATRONORM 2/1**
RECTANGULAR SERVING TRAYS
WITH HANDLES
BANDEJA RECTANGULAR CON ASAS
65 X 53 CM - 25 IN^{9/16} X 20 IN^{7/8}

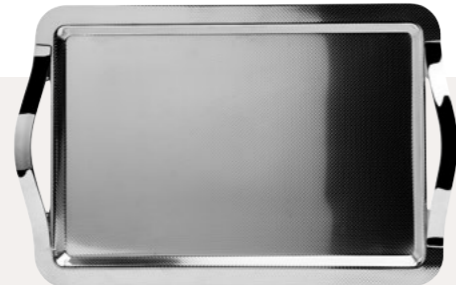

211887 + 213858
**PLATEAU RECTANGULAIRE
AVEC ANSES**
RECTANGULAR SERVING TRAYS
WITH HANDLES
BANDEJA RECTANGULAR CON ASAS
60 X 40 CM - 23 IN^{5/8} X 15 IN^{3/4}

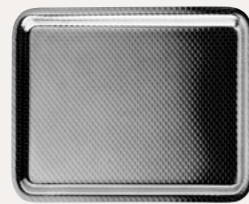

211888 + 213859
**PLATEAU RECTANGULAIRE
SANS ANSES GASTRONORM 1/2**
RECTANGULAR SERVING TRAYS
WITHOUT HANDLES
BANDEJA RECTANGULAR SIN ASAS
32,5 X 26,5 CM - 12 IN^{13/16} X 10 IN^{7/16}

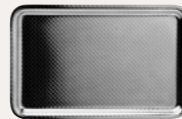

211889 + 213860
**PLATEAU RECTANGULAIRE
SANS ANSES**
RECTANGULAR SERVING TRAYS
WITHOUT HANDLES
BANDEJA RECTANGULAR SIN ASAS
22 X 14 CM - 8 IN^{7/16} X 5 IN^{1/2}

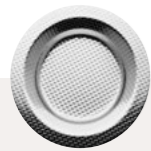

230872 + 230874
DESSOUS DE BOUTEILLE
BOTTLE COASTER
POSABOTELLA
13,5 CM - 5 IN^{5/16}



NEWPORT

SERVICE À TABLE - TABLE SERVICE - SERVICIO DE MESA



183019 + 186451
PLAT OVALE
OVAL DISH
FUENTE OVOLADO
46 X 31 CM - 18 IN^{1/8} X 12 IN^{3/16}



183018 + 186450
PLAT OVALE
OVAL DISH
FUENTE OVOLADO
41 X 28 CM - 16 IN^{1/8} X 11 IN



183017 + 186449
PLAT OVALE
OVAL DISH
FUENTE OVOLADO
38 X 25 CM - 14 IN^{5/16} X 9 IN^{13/16}



183021 + 186453
PLAT À POISSON
FISH DISH
FUENTE PARA PESCADO
60 X 27 CM - 23 IN^{5/8} X 10 IN^{5/8}



220120 + 220121
PLAT ROND CREUX
ROUND DEEP DISH
BANDEJA REDONDA
33,5 CM - 13 IN^{3/16}



186198 + 186456
SAUCIÈRE
SAUCE BOAT
SALSERA
19 X 7,6 CM - 7 IN^{1/2} X 3 IN
20 CL - 6 OZ^{3/4}



185307 + 186455
BEURRIER
BUTTER DISH
MANTEQUILLERA INDIV.
Ø 19 X 7,6 CM
Ø 3 IN X 2 IN^{3/4}



190255
**SOCLE BEURRIER
PORCELAINE**
BUTTER DISH BASE PORCELAIN
MANTEQUILLERA SIN TAPA
Ø 5 X 3,2 CM
Ø 1 IN^{5/16} X 1 IN^{1/4}



211397 +
**PORTE SUCRE
CENTRE DE TABLE**
SUGAR HOLDER/TABLE
CENTER PIECE
CENTRO DE MESA
Ø 6,4 X H 6 CM
Ø 2 IN^{1/2} X H 2 IN^{3/8}



208862 +
**PORTE SUCRE
CENTRE DE TABLE**
SUGAR HOLDER/TABLE
CENTER PIECE
CENTRO DE MESA
Ø 5 X H 6 CM
Ø 1 IN^{5/16} X H 2 IN^{3/8}



NEWPORT

CAFÉTERIE - COFFEEWARE - CAFETERA



213850 + 219563
VERSEUSE
COFFEE/TEA POT
CAFETERA/TETERA
1,5 L - 50 OZ^{3/4}
18,1 CM X H 22,4 CM
7 IN^{1/8} X H 8 IN^{3/16}



213851 + 219564
VERSEUSE
COFFEE/TEA POT
CAFETERA/TETERA
70 CL - 23 OZ^{1/16}
14,8 CM X H 14,6 CM
5 IN^{3/16} X H 5 IN^{3/4}



213852 + 219565
VERSEUSE
COFFEE/TEA POT
CAFETERA/TETERA
35 CL - 11 OZ^{13/16}
12,9 CM X H 9,3 CM
5 IN^{1/16} X H 3 IN^{1/16}



213849 + 219561
PICHET
JUG
JARRA
2 L - 67 OZ^{5/8}
18,1 CM X H 23 CM
7 IN^{1/8} X H 9 IN^{1/16}

POT ISOTHERME - INSULATED POT - JARRA ISOTÉRMICA



213846 + 219557
POT ISOTHERME
INSULATED POT
JARRA ISOTÉRMICA
1,2 L - 40 OZ^{9/16}
18,1 CM X H 22,7 CM
7 IN^{1/8} X H 8 IN^{15/16}



213847 + 219558
POT ISOTHERME
INSULATED POT
JARRA ISOTÉRMICA
70 CL - 23 OZ^{1/3}
15,6 CM X H 19,2 CM
6 IN^{1/8} X H 7 IN^{9/16}



213848 + 219559
POT ISOTHERME
INSULATED POT
JARRA ISOTÉRMICA
30 CL - 40 OZ
13,4 CM X H 12,7 CM
5 IN^{1/4} X H 5 IN



BEC VERSEUR ANTI GOUTTES
AN ANTI-SPILL
UNA BOQUILLA ANTIGOTEADO



213853 + 219566
CRÉMIER
CREAM JUG
LECHERA
35 CL - 11 OZ^{13/16}
12,9 CM X H 9 CM
5 IN^{1/16} X H 3 IN^{9/16}



213854 + 219567
CRÉMIER
CREAM JUG
LECHERA
15 CL - 5 OZ^{1/16}
9 CM X H 9 CM
3 IN^{9/16} X H 3 IN^{9/16}



182341 + 184612
SUCRIER
SUGAR BOWL
LECHERA
35 CL - 11 OZ^{13/16}

NEWPORT P. 38-43



002191 + 129797
PINCE À SUCRE
SUGAR TONG
PINZAS PARA AZÚCAR
11,5 CM - 4 IN^{1/2}



Photo non contractuelle



NEWPORT

BAR



184180 ✱ 188895 ✱
**SEAU À CHAMPAGNE
2 BOUTEILLES**
CHAMPAGNE BUCKET 2 BOTTLES
CHAMPANERA 2 BOTELLAS
Ø 24 X H 25,5 CM
Ø 9 IN^{7/16} X H 10 IN^{17/16}



186030 ✱ 188894 ✱
**SEAU À CHAMPAGNE
1 BOUTEILLE**
CHAMPAGNE BUCKET 1 BOTTLE
CHAMPANERA 1 BOTELLA
Ø 20 X H 22,5 CM
Ø 7 IN^{7/8} X H 8 IN^{7/8}



184181 ✱ 188896 ✱
**SEAU À GLACE
AVEC COUVERCLE**
ICE BUCKET WITH LID
CUBITERA CON TAPA
Ø 15 X H 16 CM
Ø 5 IN^{7/8} X H 6 IN^{5/16}

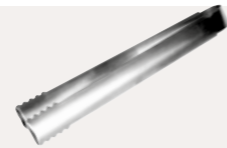

004014
PINCE À GLACE
ICE TONG
PINZA PARA HIELO
16 CM - 6 IN^{5/16}

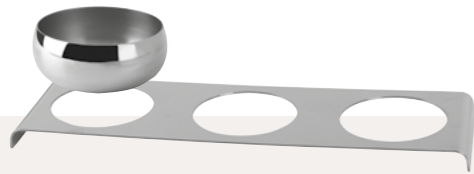

214185
COUPE ACIER
STAINLESS STEEL BOWL
TAZÓN ACERO
Ø 1,5 CM
Ø 4 IN^{1/2}

214182
PRÉSENTOIR ACIER 3 TROUS
THREE HOLES STAINLESS STEEL STAND
MIRROR FINISH
EXPOSITOR DE ACERO EN BRILLO 3 AGUJEROS
41 X 12,5 X 2,3 CM
16 IN^{1/8} X 4 IN^{5/16} X IN^{7/8}

NEWPORT
LOUNGE



NEW
234320 ✱
DESSOUS DE BOUTEILLE
BOTTLE COASTER
POSABOTELLA
9,5 CM - 3 IN^{3/4}



185607 ✱ 188893 ✱
**PORTE SEAU À CHAMPAGNE
(1 OU 2 BOUTEILLES)**
CHAMPAGNE BUCKET STAND
(1 OR 2 BOTTLES)
PORTACUBO (1/2 BOTELLAS)
H 63,5 CM - 25 IN



216919 ✱
VERRINE SEL AIMANTÉE
SALT CELLAR W/MAGNET
SALERO CON IMÁN
4,1 X 6,7 CM
1 IN^{5/8} X 2 IN^{5/8}



216920 ✱
VERRINE POIVRE AIMANTÉE
PEPPER CELLAR W/MAGNET
PIMENTERO CON IMÁN
4,1 X 6,7 CM
1 IN^{5/8} X 2 IN^{5/8}



216922 ✱
**ENSEMBLE SEL & POIVRE
AIMANTÉ**
SALT & PEPPER CELLAR W/MAGNET
CONJUNTO SALERO/PIMENTERO
CON IMÁN
8,5 X 10,6 CM
3 IN^{3/8} X 4 IN^{3/16}

ACCESSOIRES - ACCESSORIES - ACCESORIOS



182614 + 184477
CLOCHE ASSIETTE
DOME COVER, STAINLESS STEEL
CAMPANA
Ø 24 CM - 9 IN^{7/8}



182301 + 184476
CLOCHE ASSIETTE
DOME COVER, STAINLESS STEEL
CAMPANA
Ø 14,8 CM - 5 IN^{13/16}



EMPILABLES - STACKABLE - APILABLES

044113 + 101512
CLOCHE ASSIETTE
DOME COVER, STAINLESS STEEL
CAMPANA
Ø 26 CM - 10 IN^{1/4}



044112 + 101510
CLOCHE ASSIETTE
DOME COVER, STAINLESS STEEL
CAMPANA
Ø 22 CM - 8 IN^{7/8}

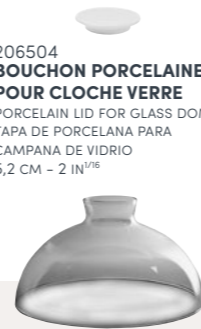

206504
BOUCHON PORCELAINE POUR CLOCHE VERRE
PORCELAIN LID FOR GLASS DOME COVER
TAPA DE PORCELANA PARA CAMPANA DE VIDRIO
5,2 CM - 2 IN^{7/8}

204043
CLOCHE VERRE BOROSILICATE
GLASS DOME COVER
CAMPANA VIDRIO BOROSILICATO
17X9 CM - 6 IN^{11/16} X 3 IN^{3/8}



120522 + 131115
CORBEILLE À PAIN RONDE EN FIL
ROUND BREAD BASKET
PANERA REDONDA
Ø 20,5 X H 7,5 CM
Ø 8 IN^{1/16} X H 2 IN^{5/16}



128910 + 131114
CORBEILLE À PAIN RONDE EN FIL
ROUND BREAD BASKET
PANERA REDONDA
Ø 17,5 X H 6 CM
Ø 6 IN^{7/8} X H 2 IN^{3/8}

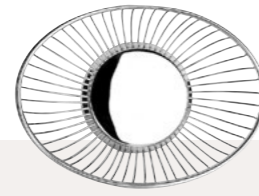

128912 + 131117
CORBEILLE À PAIN OVALE EN FIL
OVAL BREAD BASKET
PANERA OVALADA
Ø 24 X 17 CM - H 7,5 CM
Ø 9 IN^{7/16} X 6 IN^{11/16} - H 2 IN^{15/16}

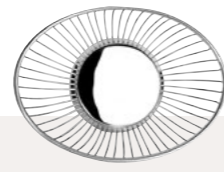

128911 + 131118
CORBEILLE À PAIN OVALE EN FIL
OVAL BREAD BASKET
PANERA OVALADA
Ø 20 X 15 CM - H 6 CM
Ø 7 IN^{7/8} X 5 IN^{7/8} - H 2 IN^{3/8}



159597 + 101453
BOL RINCE DOIGTS
FINGER BOWL
LAVADEDOS
Ø 11 X H 4 CM
Ø 4 IN^{5/16} X H 1 IN^{9/16}

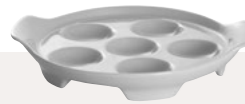

164138
PLAT À ESCARGOTS
SNAIL TRAY 6 SPACES
BANDEJA CARACOLAS 6 COMPARTIMENTOS
16,6 CM - 6 IN^{9/16}



004013
PINCE À ESCARGOTS
SNAIL TONG
PINZAS CARACOLAS
16 CM - 6 IN^{5/16}



204498 + 101492
PINCE À PAIN
BREAD TONG
PINZAS PAN
23 CM - 9 IN^{1/16}



204497 + 101493
PINCE À HOMARD
LOBSTER CRACKER
TENACILLAS PARA BOGAVANTE
18,5 CM - 7 IN^{5/16}



184492
PINCE À CRUSTACÉ
SEAFOOD CRACKER
TENACILLAS PARA CRUSTACEOS
16,5 CM - 6 IN^{1/2}



204499 + 184355
PINCE À SERVIR
SERVING TONG
PINZAS PARA SERVIR
29,5 CM - 11 IN^{5/8}



204496 + 101494
CISEAUX À GÂTEAUX
PASTRY CISSORS/TONG
PINZAS PARA PASTELES
20 CM - 7 IN^{7/8}



130994
CUILLÈRE À TOASTS
APPETIZER SPOON
CUCHARA APERITIVO
11,8 CM - 7 IN^{7/16}

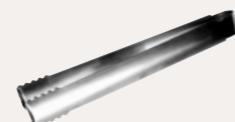

004014
PINCE À GLACE
ICE TONG
PINZAS PARA HIELO
16 CM - 6 IN^{5/16}



002191 + 129797
PINCE À SUCRE
SUGAR TONG
PINZA PARA AZÚCAR
11,5 CM - 4 IN^{1/2}



168845
CUILLÈRE À SPAGHETTI
SPAGHETTI SERVING SPOON
CUCHARA PARA ESPAGUETIS
29 CM - 11 IN^{7/16}



168846
LOUCHETTE
GRAVY LADLE
CUCHARÓN
29 CM - 11 IN^{7/16}



168844
FOURCHETTE À VIANDE
MEAT FORK
TENEDOR DE CARNE
29 CM - 11 IN^{7/16}



168843
CUILLÈRE DE SERVICE
SERVING SPOON
CUCHARA DE SERVICIO/
ENSALADA
32 CM - 12 IN^{5/8}





VERRES

Les collections de verres DEGRENNE invitent au partage et à la dégustation. Leurs qualités esthétiques ainsi que leur résistance exceptionnelle, garantissent une utilisation en toute occasion. Pour choisir en toute simplicité le verre qui révélera tous les arômes du vin, découvrez Origine : cette collection composée de 5 verres à pied permet d'associer de manière évidente un vin avec le bon verre. Pour compléter harmonieusement la table, les verres de couleur DEGRENNE, teintés dans la masse, offrent une esthétique et une qualité à l'épreuve du temps et des lavages au lave-vaisselle. Soufflée bouche de manière artisanale, chaque pièce est unique !

GLASSWARE

DEGRENNE'S glassware collections are an invitation to socialize and enjoy a drink. Our glassware's looks and exceptional sturdiness mean that it can be used at any occasion. Opt for Origine if you are looking for a glass to reveal all the flavour nuances of wine: this collection of five stemmed glasses makes it easy to combine wine with the right glass. DEGRENNE's integrally dyed glasses are a harmonious addition to the dining table and offer looks and quality that withstand the test of time and repeated washing in the dishwasher. Each hand-blown glass is unique!

CRISTALERÍA

Las colecciones de copas DEGRENNE invitan a compartir y a degustar. Sus cualidades estéticas así como su resistencia, excepcional, garantizan un uso en cualquier ocasión. Para elegir con total sencillez la copa que revele todos los aromas del vino, descubra Origine: esta colección compuesta por 5 copas de vino permite asociar de manera evidente un vino con la copa adecuada. Para completar la mesa con armonía, las copas de color DEGRENNE, pintadas en masa, ofrecen una estética y una calidad que supera el paso del tiempo y los lavados en el lavavajillas. Soplada en boca de manera artesanal, ¡cada pieza es única !





184584
FLÛTE À CHAMPAGNE
CHAMPAGNE FLÛTE
FLAUTA CHAMPÁN
27 CL - 9 OZ^{1/8}
Ø 8 X H 24,3 CM
Ø 3 IN^{1/8} X H 9 IN^{5/16}



184583
VERRE À VIN BLANC
WHITE WINE GLASS
COPA DE VINO BLANCO
35 CL - 11 OZ^{1/16}
Ø 8 X H 22,3 CM
Ø 3 IN^{1/8} X H 8 IN^{3/4}



184582
VERRE À VIN ROUGE
RED WINE GLASS
COPA DE VINO TINTO
42 CL - 14 OZ^{1/16}
Ø 8,3 X H 23,1 CM
Ø 3 IN^{1/4} X H 9 IN^{1/8}



184581
VERRE À EAU
WATER GLASS
COPA DE AGUA
48 CL - 16 OZ^{1/4}
Ø 8,9 X H 23,5 CM
Ø 3 IN^{1/2} X H 9 IN^{1/4}





184551
FLÛTE À CHAMPAGNE
CHAMPAGNE FLÛTE
FLAUTA CHAMPÁN
19 CL - 6 OZ^{7/16}
Ø 6,3 X H 22,4 CM
Ø 2 IN^{1/2} X H 8 IN^{3/16}

184549
VERRE À VIN BLANC
WHITE WINE GLASS
COPA DE VINO BLANCO
28 CL - 9 OZ^{7/16}
Ø 7,4 X H 20,8 CM
Ø 2 IN^{5/16} X H 8 IN^{3/16}

184548
VERRE À VIN ROUGE
RED WINE GLASS
COPA DE VINO TINTO
35 CL - 11 OZ^{13/16}
Ø 8 X H 21,4 CM
Ø 3 IN^{1/8} X H 8 IN^{7/16}

184547
VERRE À EAU
WATER GLASS
COPA DE AGUA
45 CL - 15 OZ^{3/16}
Ø 8,4 X H 22,5 CM
Ø 3 IN^{5/16} X H 8 IN^{1/16}

184550
VERRE À BORDEAUX
BORDEAUX GLASS
COPA DE CAVA
64,5 CL - 21 OZ^{13/16}
Ø 9,5 X H 23,8 CM
Ø 3 IN^{3/4} X H 9 IN^{3/16}

210812
VERRE À BOURGOGNE
BURGUNDY GLASS
COPA BOURGOGNE
70 CL - 23 OZ^{11/16}
Ø 10,5 X H 23,1 CM
Ø 4 IN^{1/8} X H 9 IN^{1/8}



184555
GOBELET HAUT
HIGH TUMBLER
VASO ALTO
36 CL - 12 OZ^{3/16}
Ø 6,8 X H 14,2 CM
Ø 2 IN^{11/16} X H 5 IN^{9/16}

184554
GOBELET BAS
LOW TUMBLER
VASO BAJO
33 CL - 11 OZ^{3/16}
Ø 8 X H 10,2 CM
Ø 3 IN^{1/8} X H 4 IN

184553
GOBELET BAS
LOW TUMBLER
VASO BAJO
23 CL - 7 OZ^{3/4}
Ø 7,6 X H 9,2 CM
Ø 3 IN X H 3 IN^{5/8}

184552
GOBELET BAS/VERRINE
LOW TUMBLER/APPETIZER GLASS
VASO BAJO/VASITOS
15 CL - 5 OZ^{7/16}
Ø 6,4 X H 8 CM
Ø 2 IN^{1/2} X H 3 IN^{1/8}

L'ABUS D'ALCOOL EST DANGEREUX POUR LA SANTÉ
DEGRENNÉ PROMOTES RESPONSIBLE DRINKING AND DISCOURAGES ALCOHOL MISUSE
EL ABUSO DE ALCOHOL ES PELIGROSO PARA LA SALUD



©Patrick ROUGEREAU





184556
FLÛTE À CHAMPAGNE
CHAMPAGNE FLÛTE
FLAUTA CHAMPÁN
20 CL - 6 OZ^{3/4}
Ø 6,7 X H 21,2 CM
Ø 2 IN^{5/16} X H 8 IN^{3/8}



190537
VERRE À VIN
WINE GLASS
COPA DE VINO
35 CL - 11 OZ^{13/16}
Ø 7,8 X H 19,6 CM
Ø 3 IN^{17/16} X H 7 IN^{11/16}



190536
VERRE À EAU
WATER GLASS
COPA DE AGUA
45 CL - 15 OZ^{3/16}
Ø 8,4 X H 20,5 CM
Ø 3 IN^{5/16} X H 8 IN^{17/16}



190538
GOBELET
TUMBLER
VASO
47 CL - 15 OZ^{7/8}
Ø 8,5 X H 12,1 CM
Ø 3 IN^{3/16} X H 4 IN^{3/4}



DÉCOR TAILLÉ DANS LE VERRE
CUT-GLASS DESIGN
DECORACIÓN TALLADA EN CRISTAL



Relais Bernard Loiseau





À CHAQUE VERRE SON VIN - A GLASS FOR EACH AND EVERY WINE - UN VASO PARA CADA VINO

DEGRENNÉ S'EST ASSOCIÉ À **MANUEL PEYRONDET**, MEILLEUR OUVRIER DE FRANCE SOMMELIER 2013 POUR CRÉER **ORIGINE**, LA PREMIÈRE GAMME DE 5 VERRES À PIED PERMETTANT D'ASSOCIER DE MANIÈRE SIMPLE ET ÉVIDENTE UN VIN AVEC LE BON VERRE.



DEGRENNÉ HAS JOINED FORCES WITH **MANUEL PEYRONDET**, THE 2013 WINNER OF THE PRESTIGIOUS MEILLEUR OUVRIER DE FRANCE SOMMELIER AWARD, TO CREATE **ORIGINE**, THE FIRST RANGE OF FIVE STEMMED GLASSES, MAKING IT EASY TO CHOOSE THE RIGHT GLASS FOR YOUR WINE.

DEGRENNÉ SE HA ASOCIADO CON **MANUEL PEYRONDET**, EL MEJOR OBRADOR DE FRANCIA SUMILLER DE 2013 PARA CREAR **ORIGINE**, LA PRIMERA GAMA DE 5 COPAS DE VINO, QUE PERMITE ASOCIAR DE MANERA SENCILLA Y EVIDENTE UN VINO CON LA COPA ADECUADA.

N°1

CHAMPAGNE
PROSECCO



216733
EFFERVESCENCE
EFFERVESCENCE
ESPUMA
22,5 CL - 7 OZ^{5/8}
Ø 7,1 X H 21 CM
Ø 2 IN^{3/16} X H 8 IN^{1/4}

N°2

RIESLING, SAUVIGNON,
CHENIN, GAMAY,
CABERNET, FRANC



216730
FRAÎCHEUR
FRESHNESS
FRESCURA
50 CL - 16 OZ^{5/16}
Ø 8,9 X H 21,5 CM
Ø 3 IN^{1/2} X H 8 IN^{7/16}

N°3

GRENACHE, MERLOT,
MALBEC, SYRHA
CABERNET SAUVIGNON



216731
PUISSANCE
STRENGTH
POTENCIA
50 CL - 16 OZ^{5/16}
Ø 9,5 X H 21,5 CM
Ø 3 IN^{3/4} X H 8 IN^{7/16}

N°4

PINOT NOIR,
CHARDONNAY,
BOURGOGNE



216732
SUBTILITÉ
SUBTLETY
SUTILEZA
60 CL - 20 OZ^{5/16}
Ø 10,2 X H 21,5 CM
Ø 4 IN X H 8 IN^{7/16}

N°5

POUR LES VINS MOELLEUX ET LIQUEUREUX
FOR SWEET & SYRUPY WINES
PARA LOS VINOS MELOSOS
Y LICOROSOS



216734
DOUCEUR
SWEETNESS
DULZOR
20 CL - 6 OZ^{3/4}
Ø 6,9 X H 20 CM
Ø 2 IN^{11/16} X H 7 IN^{7/16}

OUVERTURE DU BUVANT
THE OPENING OF THE RIM
LA APERTURA DE LA BOCA



POUR AFFIRMER LA TEXTURE DU VIN
AFFIRM THE WINE'S TEXTURE
PARA AFIRMAR LA TEXTURA DEL VINO

HAUTEUR DE PARAISSON
THE HEIGHT OF THE BULB
LA ALTURA DEL FONDO



POUR JOUER SUR L'EXPANSION DES BOUQUETS
ALLOW THE BOUQUETS TO FLOURISH
PARA JUGAR SOBRE LA AMPLIACIÓN DE LOS BUQUÉS

DIAMÈTRE DE PARAISSON
THE DIAMETER OF THE BULB
EL DIÁMETRO DEL FONDO

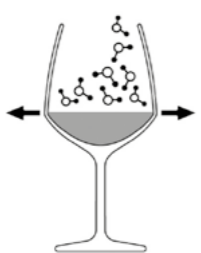

POUR LAISSER LE VIN S'OXYGÉNER
ALLOW THE WINE TO AERATE
PARA DEJAR QUE EL VINO OXIGENE

3 LEVIERS ONT ÉTÉ IDENTIFIÉS
3 KEY FACTORS WERE IDENTIFIED
SE HAN IDENTIFICADO 3 PARÁMETROS

HAUTEUR COMPATIBLE LAVE-VAISSELLE
DISHWASHER COMPATIBLE HEIGHT
ALTURA COMPATIBLE CON LAVA-VAJILLAS

SERVICE FACILITÉ PAR LA JAUGE NATURELLE DE 12 CL
SERVICE IS FACILITATED BY THE 12 CL MARKING
SERVICIO FACILITADO POR EL INDICADOR DE NIVEL NATURAL DE 12 CL



LA VERRERIE
GLASSWARE - CRISTALERÍA



184566
FLÛTE À CHAMPAGNE
CHAMPAGNE FLÛTE
FLAUTA CHAMPÁN
19 CL - 6 OZ^{7/8}
Ø 5,3 X H 21,9 CM
Ø 2 IN^{7/8} X H 8 IN^{5/8}

184563
VERRE À VIN BLANC
WHITE WINE GLASS
COPA DE VINO BLANCO
28 CL - 9 OZ^{7/8}
Ø 7,3 X H 21,2 CM
Ø 2 IN^{7/8} X H 8 IN^{3/8}

184562
VERRE À VIN ROUGE
RED WINE GLASS
COPA DE VINO TINTO
37 CL - 12 OZ^{1/2}
Ø 7,7 X H 21,4 CM
Ø 3 IN^{1/8} X H 8 IN^{7/8}

184561
VERRE À EAU
WATER GLASS
COPA DE AGUA
49,5 CL - 16 OZ^{3/4}
Ø 8,6 X H 22,7 CM
Ø 3 IN^{3/8} X H 8 IN^{5/8}

184564
VERRE À BORDEAUX
BORDEAUX GLASS
COPA DE CAVA
65 CL - 22 OZ
Ø 9,4 X H 23,9 CM
Ø 3 IN^{11/8} X H 9 IN^{7/8}

184565
VERRE À BOURGOGNE
BURGUNDY GLASS
COPA BOURGOGNE
75 CL - 25 OZ^{3/8}
Ø 10,7 X H 22,5 CM
Ø 4 IN^{3/8} X H 8 IN^{7/8}





184580
FLÛTE À CHAMPAGNE
CHAMPAGNE FLÛTE
FLAUTA CHAMPÁN
21 CL - 7 OZ^{1/8}
Ø 7 X H 21 CM
Ø 2 IN^{3/4} X H 8 IN^{1/4}

184578
VERRE À VIN
WINE GLASS
COPA DE VINO
20 CL - 6 OZ^{1/4}
Ø 7 X H 17,4 CM
Ø 2 IN^{3/4} X H 6 IN^{7/8}

184577
VERRE À VIN BLANC
WHITE WINE GLASS
COPA DE VINO BLANCO
25 CL - 8 OZ^{7/8}
Ø 7,5 X H 18,4 CM
Ø 2 IN^{5/8} X H 7 IN^{1/4}

184576
VERRE À VIN ROUGE
RED WINE GLASS
COPA DE VINO TINTO
32 CL - 10 OZ^{13/16}
Ø 7,8 X H 19,8 CM
Ø 3 IN^{7/8} X H 7 IN^{3/8}

184575
VERRE À EAU
WATER GLASS
COPA DE AGUA
42 CL - 14 OZ^{5/8}
Ø 8,7 X H 20,5 CM
Ø 3 IN^{7/8} X H 8 IN^{1/8}

184579
VERRE À BOURGOGNE
BURGUNDY GLASS
COPA BOURGOGNE
58 CL - 19 OZ^{5/8}
Ø 10 X H 20 CM
Ø 3 IN^{5/8} X H 7 IN^{7/8}

MONTMARTRE
JAUGÉ



14 CL - 4 oz^{3/4}
12,5 CL - 4 oz^{1/4}

208481
**VERRE À VIN ROUGE
AVEC DOUBLE JAUGE**
RED WINE GLASS WITH 2 GAUGE
COPA DE VINO TINTO
CON DOBLE INDICATOR
32 CL - 10 OZ^{13/16}
Ø 7,8 X H 19,8 CM
Ø 3 IN^{7/8} X H 7 IN^{3/8}

HYPNOTIC
JAUGÉ **NEW**



213816
**VERRE À VIN
AVEC DOUBLE JAUGE**
RED WINE GLASS WITH 2 GAUGE
COPA DE VINO TINTO
CON DOBLE INDICATOR
36,5 CL - 13 OZ
Ø 8,2 X H 22 CM
Ø 3 IN^{1/4} X H 8 IN^{11/16}

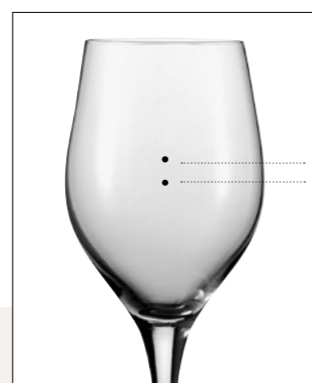

AVEC DOUBLE JAUGE
WITH 2 GAUGE
CON DOBLE INDICATOR
14 CL - 4 oz^{3/4}
12,5 CL - 4 oz^{1/4}





234148
CARAFE
PITCHER
BOTELLA
75 CL - 25 OZ^{3/8}
Ø 9,1 X H 24 CM
Ø 3 IN^{9/16} X H 4 IN^{3/8}



234149
VERRE À PIED
STEMMED GLASS
COPA
26 CL - 8 OZ^{3/4}
Ø 7,9 X H 11,1 CM
Ø 3 IN^{9/16} X H 4 IN^{3/8}



234150
GOBELET
TUMBLER
VASO
26 CL - 8 OZ^{3/4}
Ø 7,1 X H 9,1 CM
Ø 2 IN^{13/16} X H 3 IN^{9/16}



234151
VERRE À TAPAS
TAPAS GLASS
VASO DE TAPAS
17 CL - 5 OZ^{3/4}
Ø 7,9 X H 6,3 CM
Ø 3 IN^{9/16} X H 2 IN^{1/2}



VERRES EMPILABLES
STACKABLE GLASSES
VASOS APILABLES

L'ABUS D'ALCOOL EST DANGEREUX POUR LA SANTÉ
DEGRENE PROMOTES RESPONSIBLE DRINKING AND DISCOURAGES ALCOHOL MISUSE
EL ABUSO DE ALCOHOL ES PELIGROSO PARA LA SALUD



©Patrick ROUGEREAU



CARAFES DÉCANTEURS



169728
DÉCANTEUR MILLÉSIME
DECANTER
DECANTADOR
1,35 L - 45 OZ^{5/8}
Ø 20,5 X H 23,5 CM
Ø 8 IN^{7/16} X H 9 IN^{1/4}



188969
DÉCANTEUR VINDÉMIA
DECANTER
DECANTADOR
1,35 L - 45 OZ^{5/8}
Ø 23 X H 24 CM
Ø 9 IN^{7/16} X H 9 IN^{7/16}



210904
DÉCANTEUR NECTAR
DECANTER
DECANTADOR
1 L - 33 OZ^{13/16}
Ø 13,5 X H 24,5 CM
Ø 5 IN^{5/16} X H 9 IN^{5/16}



199027
CARAFE À WHISKY ANYTIME
WHISKY CARAFE
JARRA DE WHISKY
1,2 L - 40 OZ^{13/16}
Ø 9,5 X H 26 CM
Ø 3 IN^{3/4} X H 10 IN^{1/4}



202639
CARAFE À JUS DE FRUITS EVENTO
JUICE/BEVERAGE CARAFE
BOTELLA PARA ZUMOS
1,2 L - 40 OZ^{13/16}
Ø 10,5 X H 27,5 CM
Ø 4 IN^{1/8} X H 10 IN^{13/16}



202855
BOUCHON DE CARAFE SILICONE EVENTO
SILICONE STOPPER
FOR CARAFE
TAPÓN PARA BOTELLA
SILICONA
Ø 6,5 CM - 2 IN^{9/16}



NEW
234148
CARAFE EMPILEO
PITCHER
BOTELLA
75 CL - 25 OZ^{3/8}
Ø 9,1 X H 24 CM
Ø 3 IN^{9/16} X H 4 IN^{3/8}



CHAMPAGNE - CHAMPÁN



184567
FLÛTE À CHAMPAGNE
CHAMPAGNE FLÛTE
FLAUTA CHAMPÁN
15 CL - 5 OZ^{1/8}
Ø 6,3 X H 19,3 CM
Ø 2 IN^{1/2} X H 7 IN^{5/8}



184567
VERRE À CHAMPAGNE
CHAMPAGNE GLASS
FLAUTA CHAMPÁN
21 CL - 7 OZ^{1/8}
Ø 6,8 X H 20,5 CM
Ø 2 IN^{11/16} X H 8 IN^{1/8}



210281
COUPE À CHAMPAGNE
CHAMPAGNE GLASS
COPA CHAMPÁN
23 CL - 7 OZ^{3/4}
Ø 9,5 X H 14,7 CM
Ø 3 IN^{3/4} X H 5 IN^{13/16}

BIÈRE - BEER - CERVEZA



184569
VERRE À BIÈRE
BEER GLASS
VASO CERVEZA
39 CL - 13 OZ^{3/16}
Ø 7,3 X H 17,7 CM
Ø 2 IN^{7/8} X H 6 IN^{15/16}

COCKTAILS - COCTELES



195628
VERRE À MARTINI
MARTINI GLASS
COPA DE MARTINI
25 CL - 8 OZ^{2/16}
Ø 10,6 X H 16,8 CM
Ø 4 IN^{3/16} X H 6 IN^{5/8}



209814
VERRE À MARGARITA
MARGARITA GLASS
COPA DE MARGARITA
34 CL - 11 OZ^{1/2}
Ø 11,1 X H 17,2 CM
Ø 4 IN^{3/8} X H 6 IN^{1/4}



209815
VERRE À COCKTAIL
COCKTAIL GLASS
COPA COCKTAIL
48 CL - 16 OZ^{1/4}
Ø 8 X H 20,9 CM
Ø 3 IN^{1/8} X H 8 IN^{1/4}

DIGESTIF - LIQUEUR WINE - DIGESTIVOS



184570
VERRE À COGNAC
COGNAC GLASS
VASO COÑAC
61 CL - 20 OZ^{5/8}
Ø 10,4 X H 15,5 CM
Ø 4 IN^{1/8} X H 6 IN^{5/8}



190700
**VERRE À PORTO/
SHERRY**
SHERRY GLASS
COPA JEREZ/OPORTO
10,4 CL - 3 OZ^{1/2}
Ø 5,6 X H 16,9 CM
Ø 2 IN^{5/16} X H 6 IN^{5/8}



209813
VERRE À SHOOTER
SHOT GLASS
COPA SHOOTER
4,5 CL - 1 OZ^{1/2}
Ø 4,6 X H 8 CM
Ø 1 IN^{15/16} X H 3 IN^{1/8}

VERRINES - APPETIZER GLASSES - VASITOS



181874
VERRINE RONDO
APPETIZER GLASS
VASITO
13 CL - 4 OZ^{1/8}
Ø 5,5 X H 6 CM
Ø 2 IN^{3/16} X H 2 IN^{3/8}



109439
COUPELLE BRAZIL
APPETIZER GLASS
VASO
30 CL - 10 OZ^{1/8}
Ø 13,2 X H 8,7 CM
Ø 5 IN^{37/16} X H 3 IN^{7/16}



210811
OSLO BOL
BOWL
COPA/VASITO
30 CL - 10 OZ^{1/8}





184555
GOBELET HAUT
HIGH TUMBLER
VASO ALTO
36 CL - 12 OZ^{3/16}
Ø 6,8 X H 14,2 CM
Ø 2 IN^{11/16} X H 5 IN^{9/16}



184554
GOBELET BAS
LOW TUMBLER
VASO BAJO
33 CL - 11 OZ^{3/16}
Ø 8 X H 10,2 CM
Ø 3 IN^{11/8} X H 4 IN



184553
GOBELET BAS
LOW TUMBLER
VASO BAJO
23 CL - 7 OZ^{3/4}
Ø 7,6 X H 9,2 CM
Ø 3 IN X H 3 IN^{5/8}



184552
GOBELET BAS/VERRINE
LOW TUMBLER/APPETIZER
GLASS
VASO BAJO/VASITOS
15 CL - 5 OZ^{1/16}
Ø 6,4 X H 8 CM
Ø 2 IN^{1/2} X H 3 IN^{1/8}



184601
GOBELET HAUT
HIGH TUMBLER
VASO ALTO
39 CL - 13 OZ^{3/16}
Ø 6,6 X H 14,5 CM
Ø 2 IN^{5/8} X H 5 IN^{11/16}



184600
GOBELET BAS
LOW TUMBLER
VASO BAJO
35 CL - 11 OZ^{13/16}
Ø 7,9 X H 9,1 CM
Ø 3 IN^{11/8} X H 3 IN^{9/16}



184598
GOBELET BAS/VERRINE
LOW TUMBLER/APPETIZER
GLASS
VASO BAJO/VASITOS
19 CL - 6 OZ^{7/16}
Ø 6,7 X H 8,1 CM
Ø 2 IN^{5/8} X H 3 IN^{3/16}



184589
GOBELET HAUT
HIGH TUMBLER
VASO ALTO
35 CL - 11 OZ^{13/16}
Ø 6,5 X H 14,4 CM
Ø 2 IN^{5/16} X H 5 IN^{11/16}



184588
GOBELET HAUT
HIGH TUMBLER
VASO ALTO
29 CL - 9 OZ^{13/16}
Ø 7 X H 10,7 CM
Ø 2 IN^{3/4} X H 4 IN^{3/16}



189774
GOBELET BAS
LOW TUMBLER
VASO BAJO
42 CL - 14 OZ^{2/16}
Ø 8,5 X H 10,6 CM
Ø 3 IN^{3/4} X H 4 IN^{3/16}



184586
GOBELET BAS
LOW TUMBLER
VASO BAJO
32 CL - 10 OZ^{13/16}
Ø 8 X H 9,4 CM
Ø 3 IN^{1/2} X H 3 IN^{11/16}



DOLCE



VERRES SOUFFLÉS BOUCHE TEINTÉS DANS LA MASSE
HAND-BLOWN INTEGRALLY DYED GLASSES
VASOS SOPLADOS A BOCA, PINTADOS EN MASA



169851
**Gobelet Haut
Transparent**
Transparent High Tumbler
Vaso Alto Transparent
57 CL - 19 OZ^{1/4}
Ø 6,7 X H 11,5 CM
Ø 2 IN^{5/8} X H 4 IN^{1/2}



169852
**Gobelet Bas
Transparent**
Transparent Low Tumbler
Vaso Bajo Transparent
43 CL - 14 OZ^{2/16}
Ø 6,1 X H 10 CM
Ø 2 IN^{3/8} X H 3 IN^{15/16}



169854
**Gobelet Bas
Mauve**
Purple Low Tumbler
Vaso Bajo Malva
43 CL - 14 OZ^{2/16}
Ø 6,1 X H 10 CM
Ø 2 IN^{3/8} X H 3 IN^{15/16}



169856
**Gobelet Bas
Gris**
Grey Low Tumbler
Vaso Bajo Gris
43 CL - 14 OZ^{2/16}
Ø 6,1 X H 10 CM
Ø 2 IN^{3/8} X H 3 IN^{15/16}



231470
**Gobelet Bas
Transparent Sablé**
Transparent Sand Low Tumbler
Vaso Bajo Transparent Arena
43 CL - 14 OZ^{2/16}
Ø 6,1 X H 10 CM
Ø 2 IN^{3/8} X H 3 IN^{15/16}



VERRES SOUFFLÉS BOUCHE TEINTÉS DANS LA MASSE
HAND-BLOWN INTEGRALLY DYED GLASSES
VASOS SOPLADOS A BOCA, PINTADOS EN MASA



NEW
234489
**Gobelet
Transparent**
Transparent Tumbler
Vaso Transparent
40 CL - 13 OZ^{1/2}
Ø 8 X H 12,1 CM
Ø 3 IN^{1/8} X H 4 IN^{3/4}



206936
**Gobelet
Transparent**
Transparent Tumbler
Vaso Transparent
29 CL - 9 OZ^{13/16}
Ø 7,2 X H 9,5 CM
Ø 2 IN^{13/16} X H 3 IN^{3/4}



NEW
234491
**Gobelet
Gris**
Grey Tumbler
Vaso Gris
40 CL - 13 OZ^{1/2}
Ø 8 X H 12,1 CM
Ø 3 IN^{1/8} X H 4 IN^{3/4}



225517
**Gobelet
Gris**
Grey Tumbler
Vaso Gris
29 CL - 9 OZ^{13/16}
Ø 7,2 X H 9,5 CM
Ø 2 IN^{13/16} X H 3 IN^{3/4}



NEW
234490
**Gobelet
Bleu Nuit**
Blue Night Tumbler
Vaso Azul
40 CL - 13 OZ^{1/2}
Ø 8 X H 12,1 CM
Ø 3 IN^{1/8} X H 4 IN^{3/4}



199461
**Gobelet
Bleu Nuit**
Blue Night Tumbler
Vaso Azul
29 CL - 9 OZ^{13/16}
Ø 7,2 X H 9,5 CM
Ø 2 IN^{13/16} X H 3 IN^{3/4}



180939
**Gobelet
Blanc**
White Tumbler
Vaso Blanco
29 CL - 9 OZ^{13/16}
Ø 7,2 X H 9,5 CM
Ø 2 IN^{13/16} X H 3 IN^{3/4}



225516
**Gobelet
Rouge**
Red Tumbler
Vaso Rojo
29 CL - 9 OZ^{13/16}
Ø 7,2 X H 9,5 CM
Ø 2 IN^{13/16} X H 3 IN^{3/4}



180936
**Gobelet
Noir**
Black Tumbler
Vaso Negro
29 CL - 9 OZ^{13/16}
Ø 7,2 X H 9,5 CM
Ø 2 IN^{13/16} X H 3 IN^{3/4}



199462
**Gobelet
Vert Pomme**
Apple Green Tumbler
Vaso Verde
29 CL - 9 OZ^{13/16}
Ø 7,2 X H 9,5 CM
Ø 2 IN^{13/16} X H 3 IN^{3/4}



174510
**Gobelet
Cassis**
Purple Tumbler
Vaso Púrpura
29 CL - 9 OZ^{13/16}
Ø 7,2 X H 9,5 CM
Ø 2 IN^{13/16} X H 3 IN^{3/4}

ALLEGRO



MAMBO



VERRES SOUFFLÉS BOUCHE TEINTÉS DANS LA MASSE
HAND-BLOWN INTEGRALLY DYED GLASSES
VASOS SOPLADOS A BOCA, PINTADOS EN MASA



171631
GOBELET GRIS
GREY TUMBLER
VASO GRIS
34 CL - 11 OZ^{1/2}
Ø 8,5 X H 10 CM
Ø 3 IN^{3/8} X H 3 IN^{15/16}



171632
GOBELET VERT
GREEN TUMBLER
VASO VERDE
34 CL - 11 OZ^{1/2}
Ø 8,5 X H 10 CM
Ø 3 IN^{3/8} X H 3 IN^{15/16}



171633
GOBELET VIOLET
PURPLE TUMBLER
VASO VIOLETA
34 CL - 11 OZ^{1/2}
Ø 8,5 X H 10 CM
Ø 3 IN^{3/8} X H 3 IN^{15/16}



171630
GOBELET ROUGE
RED TUMBLER
VASO ROJO
34 CL - 11 OZ^{1/2}
Ø 8,5 X H 10 CM
Ø 3 IN^{3/8} X H 3 IN^{15/16}



VERRES SOUFFLÉS BOUCHE TEINTÉS DANS LA MASSE
HAND-BLOWN INTEGRALLY DYED GLASSES
VASOS SOPLADOS A BOCA, PINTADOS EN MASA



NEW
235133
GOBELET ARGILE VERTE
GREEN CLAY TUMBLER
VASO ARCILLA VERDE
30 CL - 10 OZ^{2/5}
Ø 8,8 X H 8,8 CM
Ø 3 IN^{7/16} X H 3 IN^{7/16}



230891
GOBELET GRIS
GREY TUMBLER
VASO GRIS
30 CL - 10 OZ^{2/5}
Ø 8,8 X H 8,8 CM
Ø 3 IN^{7/16} X H 3 IN^{7/16}



230890
GOBELET SABLE ROSE
PINK TUMBLER
VASO ROSE
30 CL - 10 OZ^{2/5}
Ø 8,8 X H 8,8 CM
Ø 3 IN^{7/16} X H 3 IN^{7/16}



230889
GOBELET BLEU DE ROCHE
BLUE TUMBLER
VASO AZUL
30 CL - 10 OZ^{2/5}
Ø 8,8 X H 8,8 CM
Ø 3 IN^{7/16} X H 3 IN^{7/16}



VERRES EMPILABLES
STACKABLE GLASSES
VASOS APILABLES



BILBAO





LE BUFFET EVENTO

Du petit-déjeuner au dîner, des buffets sucrés aux buffets salés, la collection **EVENTO** répond à tous les scénarios de réception. Un design **homogène, harmonieux, fonctionnel et modulable**. La **richesse de ses combinaisons** et la **diversité de ses matériaux** (acier, porcelaine, verre, grès, mélamine pierre et bois etc...) **s'adaptent à votre style** et à la **dimension de votre établissement**. La collection **EVENTO** valorise avec une touche de chic la mise en scène de vos buffets, selon le moment de la journée, de la saison...

KITCHENWARE FOR YOUR BUFFET

From **breakfast to dinner**, from sweet buffets to savoury spreads, the **EVENTO** collection works for all your reception needs. A **unified, harmonious, practical and modular** design. With a **host of combinations** and a **range of materials** to choose from (steel, porcelain, glass, stoneware, melamine, stone and wood...), you can find what **works for your style** and the **size of your space**. The **EVENTO** collection adds a chic touch to your buffet presentations to reflect the time of day or the season.

CREACIÓN DE UN BUFÉ

La colección **EVENTO** resulta perfecta para cualquier recepción, tanto para bufés dulces como salados, del **desayuno a la cena**. Un diseño **homogéneo, armonioso, funcional y modulable**. La **riqueza de sus combinaciones** y la **diversidad de sus materiales** (acero, porcelana, cristal, gres, melamina de piedra y madera...) **se amoldan a su estilo** y a las **dimensiones de su establecimiento**. La colección **EVENTO** aporta un toque sofisticado para realzar la presentación de sus bufés según el momento del día, de la temporada.

EVENTO
PLATEAUX POUR MODULES FROIDS P.204
PLATTERS FOR REFRIGERATED UNITS - BANDEJAS PARA LOS MODULOS REFRIGERADOS
234562 - PLATEAU ROND MÉLAMINE PIERRE P.212
STONE MELAMINE ROUND TRAY - BANDEJA REDONDA MELAMINA PIEDRA



CHAFING DISHES*

LE CHAFING DISH, PAR SON DESIGN CONTEMPORAIN ALLIANT ACIER, PORCELAINE ET VERRE OFFRE À VOTRE BUFFET UNE PRÉSENTATION SOIGNÉE ET RAFFINÉE.

THE CHAFING DISH, WITH ITS CONTEMPORARY DESIGN THAT COMBINES STEEL, PORCELAIN AND GLASS, BRINGS A SMART AND SOPHISTICATED TOUCH TO YOUR BUFFET DISPLAY.

EL CHAFING DISH, POR SU DISEÑO CONTEMPORÁNEO QUE COMBINA ACERO, PORCELANA Y CRISTAL OFRECE A SU BUFFET UNA PRESENTACIÓN CUIDADA Y REFINADA.

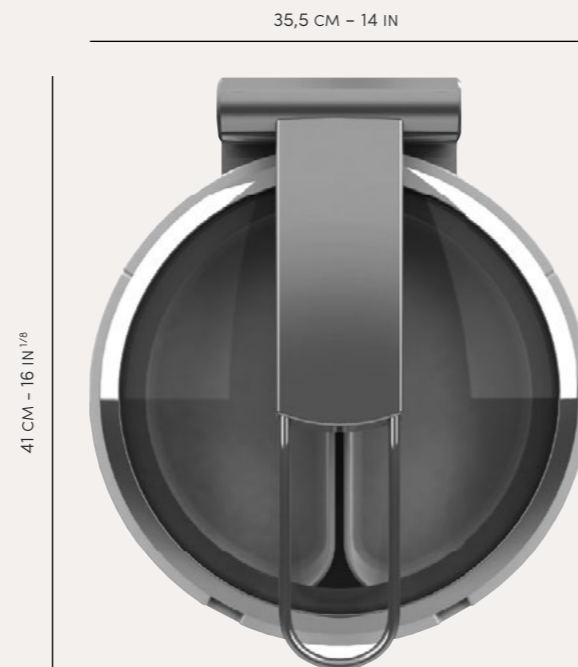

Ø 35,5 CM X P 41 CM X H 15 CM
Ø 14 IN X D 16 IN^{1/8} X H 5 IN^{7/8}

Charnière avec vérin et amortisseur pour un réel confort d'utilisation et une fermeture en douceur

The hydraulic buffering hinge offers user comfort and convenience with its soft closure mechanism

La bisagra con amortiguación hidraulica ofrece al usuario comodidad y conveniencia con su mecanismo de cierre suave

Couvercle en verre transparent pour percevoir le contenu et rendre le buffet plus gourmand

Clear glass cover allows contents to be viewed instantly and makes the buffet more enticing

Cubierta de vidrio transparente permite que el contenido pueda ser visto instantáneamente y hace que el buffet más atractivo



Encoches pour les couverts de service

The notch for the serving cutlery

El agua condensada se recoge mediante un sistema de la ranura para las piezas de servicio

Système de récupération d'eau de condensation

Condensation water collection system in the porcelain insert

El agua condensada se recoge mediante un sistema de recolección en la base de porcelana

Compatible plaque induction, avec résistance électrique ou porte-brûleur avec gel combustible

Compatible with induction, electrical and/or «sterno» fuel heating system

Compatible con induccion, eléctrico o sistema de color externo

*CERTAINES PIÈCES SONT DISPONIBLES EN PIÈCES DÉTACHÉES
SOME ITEMS ARE AVAILABLE INDIVIDUALLY
ALGUNOS DE ESTOS ARTICULOS ESTÁN DISPONIBLES COMO PIEZAS SEPARADAS



236195 **NEW**

CHAFING DISH SANS BAC FINITION MIROIR

CHAFING DISH WITHOUT INSERT MIRROR FINISH
CHAFING DISH SIN BANDEJA ACABADO BRILLO
Ø 35,5 CM - P 41 CM - H 15 CM
Ø 14 IN - D 16 IN^{7/8} - H 5 IN^{7/8}

Acier inoxydable, couvercle avec gouttière, verre trempé
Stainless steel, lid with groove, tempered glass
Acero inoxidable, tapa con canalón vidrio templado



216143 **CHAFING DISH BAC ACIER INCLUS FINITION MIROIR**
CHAFING DISH INSERT MIRROR FINISH
CHAFING DISH CON BANDEJA ACABADO BRILLO



215722 **CHAFING DISH BAC PORCELAINE INCLUS FINITION MIROIR**
CHAFING DISH MIRROR FINISH PORCELAIN INSERT INCLUDED
CHAFING DISH CON BANDEJA ACABADO BRILLO - PORCELANA



203005 **FINITION MIROIR**
MIRROR FINISH
ACABADO BRILLO

236194 **NEW**

CHAFING DISH SANS BAC FINITION BROSSÉE

CHAFING DISH WITHOUT INSERT BRUSHED FINISH
CHAFING DISH SIN BANDEJA ACABADO SATINADO
Ø 35,5 CM - P 41 CM - H 15 CM
Ø 14 IN - D 16 IN^{7/8} - H 5 IN^{7/8}

Acier inoxydable, couvercle avec gouttière, verre trempé
Stainless steel, lid with groove, tempered glass
Acero inoxidable, tapa con canalón vidrio templado



216144 **CHAFING DISH BAC ACIER INCLUS FINITION BROSSÉE**
CHAFING DISH INSERT BRUSHED FINISH
CHAFING DISH SIN BANDEJA ACABADO SATINADO



215723 **CHAFING DISH BAC PORCELAINE INCLUS FINITION BROSSÉE**
CHAFING DISH BRUSHED FINISH PORCELAIN INSERT INCLUDED
CHAFING DISH CON BANDEJA ACABADO SATINADO - PORCELANA

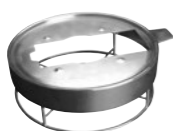

202859 **FINITION BROSSÉE**
BRUSHED FINISH
ACABADO SATINADO



203470 **COUVERCLE AVEC GOUTTIÈRE ACIER, VERRE TREMPÉ**
LID WITH STAINLESS STEEL GUTTER, TEMPERED GLASS
TAPA EN ACERO INOX Y VIDRIO TEMPLADO
Ø 33 CM - 13 IN



202635 **1/2 BAC PORCELAINE POUR CHAFING DISH**
1/2 CHAFING PORCELAIN INSERT
1/2 BANDEJA DE PORCELANA PARA CHAFING
L 29 X L15 X H 4,5 CM
CONTENANCE 1L
11 IN^{7/8} X 5 IN^{7/8} X 1 IN^{3/4}
CAPACITY 33 OZ^{15/16}



215721 **BAC PORCELAINE POUR CHAFING DISH**
CHAFING PORCELAIN INSERT
BANDEJA DE PORCELANA PARA CHAFING
Ø 35,6 X H 7 CM
CONTENANCE 3L
Ø 14 X 2 IN^{3/4}
CAPACITY 100 OZ



216142 **BAC ACIER POUR CHAFING DISH**
CHAFING STAINLESS STEEL INSERT
BANDEJA DE ACERO INOXIDABLE PARA CHAFING
Ø 35,6 X H 7 CM
CONTENANCE 3L
Ø 14 X 2 IN^{3/4}
CAPACITY 100 OZ



202860 **RÉSISTANCE AVEC RÉGULATEUR DE TEMPÉRATURE**
HEATING ELEMENT - HEAT ADJUSTABLE
RESISTENCIA CON REGULADOR DE TEMPERA
202860 - 220 /240 V
203468 - 110 /120 V
20 X 20 CM
7 IN^{7/8} X 7 IN^{7/8}



202861 **PORTE-BRÛLEUR POUR GEL COMBUSTIBLE ACIER**
BURNER HOLDER STEEL
QUEMADOR ACERO INOXIDABLE
Ø 9 CM - H 6 CM
Ø 3 IN^{9/16} X 2 IN^{1/8}



MODULES FROIDS*

REFRIGERATED UNITS - MODULOS REFRIGERADOS

LE MODULE RÉFRIGÉRÉ REÇOIT UNE LARGE GAMME DE CONTENANTS, PLATEAUX ET ACCESSOIRES MULTI-MATÉRIAUX AU FORMAT GN EN PORCELAINE, VERRE, ACIER, BAMBOU, ACRYLIQUE, MÉLAMINE PIERRE ET MÉLAMINE BOIS. ILS PERMETTENT UNE INFINITÉ DE COMBINAISONS.

THE REFRIGERATED UNIT WILL HOLD A WIDE RANGE OF PLATTERS AND MULTI-MATERIAL ACCESSORIES IN INDUSTRY STANDARD FORMAT IN PORCELAIN, GLASS, STEEL, BAMBOO, ACRYLIC STONE AND WOOD MELAMINE ALLOWING ENDLESS COMBINATIONS.

EL MÓDULO REFRIGERADO PRESENTA UNA AMPLIA VARIEDAD DE BANDEJAS Y ACCESORIOS DE MÚLTIPLES MATERIALES EN FORMATO GN EN PORCELANA, VIDRIO, ACERO, BAMBÚ, ACRÍLICO, MELAMINA DE PIEDRA Y MELAMINA MADERA QUE PERMITEN UN NÚMERO INFINITO DE COMBINACIONES.



MODULE ACIER GN 1/1⁽¹⁾
+ BAC PLASTIQUE

REFRIGERATED SET
+ PLASTIC TRAY GN 1/1
MODULO DE ACERO
+ BANDEJA GN 1/1
L 56,5 CM - P 36 CM - H 9,5 CM
22 IN^{1/4} - D 14 IN^{3/16} X 3 IN^{3/4}

202864
FINITION MIROIR
STAINLESS STEEL MIRROR
ACABADO BRILLO

202865
FINITION BROSSÉE
STAINLESS STEEL BRUSHED
ACABADO SATINADO

202869
NOIR MÉTALLISÉ
METALLIC BLACK
ACABADO NEGRO METALICO

202866
BAC PLASTIQUE
PLASTIC TRAY
BANDEJA

MODULE ACIER GN 1/2⁽¹⁾
+ BAC PLASTIQUE

REFRIGERATED SET
+ PLASTIC TRAY GN 1/2
MODULO DE ACERO
+ BANDEJA GN 1/2
L 29,5 X 35,6 CM
11 IN^{5/8} X 14 IN

235356
FINITION MIROIR
STAINLESS STEEL MIRROR
ACABADO BRILLO

235361
FINITION BROSSÉE
STAINLESS STEEL BRUSHED
ACABADO SATINADO

235362
NOIR MÉTALLISÉ
METALLIC BLACK
ACABADO NEGRO METALICO

(1) GARANTIE LAVE-VAISSELLE
DISH WASHER SAFE
GARANTIA LAVA-VAJILLAS

* CERTAINES PIÈCES SONT DISPONIBLES EN PIÈCES DÉTACHÉES
SOME ITEMS ARE AVAILABLE INDIVIDUALLY
ALGUNOS DE ESTOS ARTICULOS ESTÁN DISPONIBLES COMO PIEZAS SEPARADAS

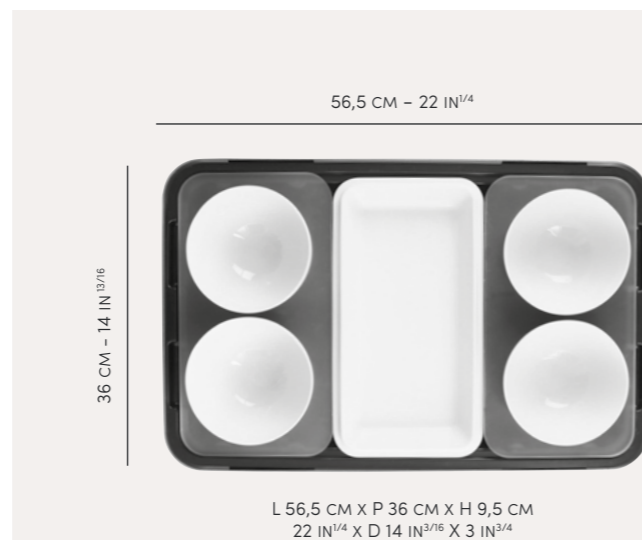

202871
COUVERCLE MODULE
RÉFRIGÉRÉ POIGNÉE INOXYDABLE

LID FOR REFRIGERATED SET/
STAINLESS STEEL HANDLE
CUBIERTA PARA EL MÓDULO
REFRIGERADO/ASA ACERO INOXIDABLE
56 X 35 X 19 CM
22 IN^{1/8} X 13 IN^{3/4} X 7 IN^{1/2}

208357
PLAQUE EUTECTIQUE POUR
MODULE FROID GN1/1

BLACK COOLING
EUTECTIQUE BLOCK FOR UNIT GN1/1
NEGRO ACUMULADOR DE
REFRIGERACION 1/1
48 X 28 X 3 CM
18 IN^{7/8} X 11 IN X 1 IN^{3/16}

234568
PLAQUE EUTECTIQUE POUR
MODULE FROID GN 1/2

BLACK COOLING
EUTECTIQUE BLOCK FOR UNIT GN1/2
NEGRO ACUMULADOR DE
REFRIGERACION 1/2
18 X 25 CM
7 IN^{5/16} X 9 IN^{13/16}



PLATEAUX POUR MODULES FROIDS

PLATTERS FOR REFRIGERATED UNITS
BANDEJAS PARA LOS MODULOS REFRIGERADOS

	GN 1/1 53,5 X 32,5 CM 20 IN 7/8 X 12 IN 13/16	GN 2/3 35,4 X 32,5 CM 13 IN 15/16 X 12 IN 13/16	GN 1/2 26,4 X 32,5 CM 10 IN 3/8 X 12 IN 13/16	GN 1/3 17,5 X 32,5 CM 6 IN 7/8 X 12 IN 13/16	GN 1/6 8,7 X 32,5 CM 3 IN 7/16 X 12 IN 13/16
PLATEAU GRÈS CARBONE⁽²⁾ GRES STONEWARE TRAY BANDEJA GRES TONO CARBONO		NEW 		NEW NEW 	
234550 - GN2/3 234555 - GN1/3					
PLAT CREUX GRÈS CARBONE⁽²⁾ GRES STONEWARE DEEP DISH BANDEJA GRES TONO CARBONO					
234556 - GN1/3					
PLATEAU PORCELAINE WHITE ENAMELLED PORCELAIN TRAY BANDEJA PORCELANA					
202628 - GN2/3 202629 - GN1/2 202627 - GN1/3					
PLAT CREUX PORCELAINE WHITE ENAMELLED PORCELAIN DEEP DISH BANDEJA PORCELANA					
202630 - GN1/3					
PLATEAU BAMBOU ÉPAISSEUR 1,5 CM OILED BAMBOO TRAY THICKNESS 3/16 BANDEJA BAMBOU GROSOR 1,5 CM					
202919 - GN1/1 202920 - GN2/3					
PLATEAU MÉLAMINE BOIS⁽³⁾ WOOD MELAMINE TRAY BANDEJA MELAMINA MADERA	NEW 	NEW 	NEW 	NEW 	NEW
234546 - GN1/1 234548 - GN2/3 234551 - GN1/2 234553 - GN1/3					
PLATEAU 3 TROUS MÉLAMINE BOIS⁽³⁾ WOOD MELAMINE TRAY 3 HOLES BANDEJA MELAMINA MADERA CON 3 HUELLAS					
234557 - GN1/6					
PLATEAU MÉLAMINE PIERRE⁽³⁾ STONE MELAMINE TRAY BANDEJA MELAMINA PIEDRA	NEW 	NEW 	NEW 	NEW 	NEW
234547 - GN1/1 234549 - GN2/3 234552 - GN1/2 234554 - GN1/3					
PLATEAU 3 TROUS MÉLAMINE PIERRE⁽³⁾ STONE MELAMINE TRAY 3 HOLES BANDEJA MELAMINA PIEDRA CON 3 HUELLAS					
234558 - GN1/6					
PLATEAU ACIER 18-10 NEWPORT FINITION MIROIR SERVING TRAY STAINLESS STEEL 18-10 MIRROR FINISHED BANDEJA RECTANGULAR ACERO 18-10 ACABADO BRILLO					
185021 - GN1/1 185019 - GN1/2					
PLATEAU VERRE ÉPAISSEUR 0,6 CM TEMPERED GLASS TRAY THICKNESS 1/4 BANDEJA CRISTAL GROSOR 0,6 CM					
230752 - GN1/1 230753 - GN2/3					
PLATEAU ACRYLIQUE ÉPAISSEUR 1 CM ACRYLIC TRAY THICKNESS 3/8 BANDEJA ACRÍLICO GROSOR 1 CM					
2 TROUS - 2 HOLES - 2 AGUJEROS 230756 - GN1/1					
1 TROU - 1 HOLE - 1 AGUJERO 230755 - GN1/2 Adapté aux bols 22 cm - Adapted for bowls 8,6 inch - Adaptados a boles de 22 cm					
2 TROUS - 2 HOLES - 2 AGUJEROS 230757 - GN1/3 Adapté aux bols 14 cm - Adapted for bowls 5,5 inch - Adaptados a boles de 14 cm					

(2) GARANTIE LAVE-VAISSELLE
DISH WASHER SAFE
GARANTIA LAVA-VAJILLAS

(2) GARANTIE MICRO-ONDES
MICROWAVE SAFE
GARANTIA MICRO-ONDAS

(3) COMPATIBLE LAVE-VAISSELLE
DISH WASHER SAFE
GARANTIA LAVA-VAJILLAS

(3) NON COMPATIBLE MICRO-ONDES
DON'T USE WITH MICRO-WAVE
NO VA EN EL MICRO-ONDAS



URNES À JUS DE FRUITS*
FRUIT JUICE URNS - DISPENSADORES DE ZUMOS

URNE À JUS DE FRUIT DOTÉE D'UN TUBE CENTRAL EN ACIER POUR GLACE PILÉE :
PARFAIT MAINTIEN DE LA FRAÎCHEUR

FRUIT JUICE URN WITH CENTRAL STEEL TUBE TO HOLD CRUSHED ICE,
FOR PERFECT FRESHNESS

DISPENSADOR DE ZUMOS DOTADO CON UN TUBO CENTRAL DE ACERO
PARA HIELO PICADO **PARA MANTENER LA FRESCURA**

URNE À JUS DE FRUITS 4L - ACIER 18-10
JUICE DISPENSER 135 OZ STAINLESS STEEL
DISPENSADOR DE ZUMO ACERO

231303
MIROIR
MIRROR
ACABADO BRILLO

231304
BROSSÉ
BRUSHED
ACABADO SATINADO

202855
BOUCHON DE CARAFE SILICONE
STOPPER FOR CARAFE - SILICONE
TAPÓN PARA BOTELLA - SILICONA

Ø 6,5 CM - H 4,2 CM
Ø 2 IN^{5/8} X H 1 IN^{5/8}



202639
CARAFE À JUS DE FRUIT
VERRE - 1,2 L
CRISTALLIN SOUFLÉ BOUCHE

JUICE/BEVERAGE CARAFE
40 OZ^{3/16} HAND BLOWN CRYSTALLINE
BOTELLA PARA ZUMOS
CRISTAL SOPLADO EN BOCA
Ø 10,5 CM - H 27,5 CM
Ø 4 IN^{1/8} X H 10 IN^{13/16}

202632
ÉTIQUETTE PORCELAIN
AVEC AIMANT+ SUPPORT ACIER

PORCELAIN STICK + STAINLESS STEEL STAND
WITH MAGNET
ETIQUETA PORCELANA + SOPORTE ACERO
INOX CON IMÁN
10 X 5 CM - 3 IN^{5/16} X 1 IN^{15/16}



* CERTAINES PIÈCES SONT DISPONIBLES EN PIÈCES DÉTACHÉES
SOME ITEMS ARE AVAILABLE INDIVIDUALLY
ALGUNOS DE ESTOS ARTICULOS ESTÁN DISPONIBLES COMO PIEZAS SEPARADAS



BOUCHON VERSEUR
EN SILICONE, POUR UNE
MEILLEURE HYGIÈNE

HYGIENIC SILICONE
POURING STOPPER

TAPÓN DE SILICONA PARA MAYOR
HIGIENE Y CONTROL
DEL VERTIDO

POSSIBILITÉ D'AIMANTER
L'ÉTIQUETTE PORCELAIN
SUR LE COUVERCLE

MAGNETIC PORCELAIN
NAME PLATE ACCESSORY
FOR LID PLACEMENT

PLACA DE **PORCELANA**
MAGNÉTICA PARA COLOCAR
LOS NOMBRES



DISTRIBUTEURS À CÉRÉALES*

CEREAL DISPENSERS - DISPENSADORES DE CEREALES

DISTRIBUTEUR À CÉRÉALES 1 OU 3 TUBES
AVEC AILETTES SOUPLES POUR NE PAS CASSER LES CÉRÉALES

CEREAL DISPENSER 1 OR 3 TUBS WITH
FLEXIBLE SPOUT SO AS NOT TO BREAK THE CEREALS

DISPENSADOR DE CÉRÉALES 1 O 3 TUBOS CON
PESTAÑAS FLEXIBLES PARA NO ROMPER LOS CEREALES



50 CM - 19 IN^{11/16}

214160 - X3
L 50 CM X P 20 CM X H 55,5 CM
W 19 IN^{11/16} X D 7 IN^{7/8} X H 21 IN^{7/8}
CAPACITÉ : 3 X 3,5 L
CAPACITY : 3 X 1 GAL

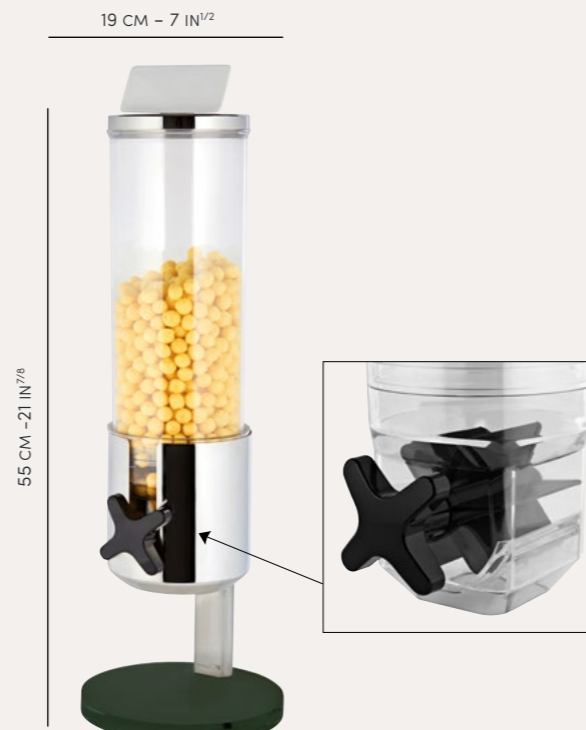

19 CM - 7 IN^{1/2}

55 CM - 21 IN^{7/8}

214159 - X1
L 19 CM X P 20 CM X H 55,5 CM
W 7 IN^{1/2} X D 7 IN^{7/8} X H 21 IN^{7/8}
CAPACITÉ : 3,5 L
CAPACITY : 1 GAL

202855
**BOUCHON DE CARAFE
SILICONE**

STOPPER FOR CARAFE
SILICONE
TAPÓN PARA BOTELLA
SILICONA
Ø 6,5 CM - H 4,2 CM
Ø 2 IN^{9/16} X H 1 IN^{5/8}



202636
**CARAFE À LAIT
PORCELAINE - 1,2 L**

PORCELAIN MILK JUG
40 OZ^{9/16}
BOTELLA PARA LECHE
PORCELANA
Ø 10,5 CM - H 27,5 CM
Ø 4 IN^{1/8} X H 10 IN^{13/16}



154245
BOL MODULO BLANC
WHITE MODULO BOWL
BOL MODULO BLANCO
14 CM - 5 IN^{1/2}



202636
BOL EMPILABLE
PORCELAIN STACKABLE BOWL
BOWL PORCELANA APILABLE
14 CM - 5 IN^{1/2}



* CERTAINES PIÈCES SONT DISPONIBLES EN PIÈCES DÉTACHÉES
SOME ITEMS ARE AVAILABLE INDIVIDUALLY
ALGUNOS DE ESTOS ARTICULOS ESTÁN DISPONIBLES COMO PIEZAS SEPARADAS

SUPPORTS À FIL RECTANGULAIRES
RECTANGULAR TRAYS - SOPORTES RECTANGULAIRES

DES SUPPORTS EN ACIER NOIR MAT DE HAUTEURS DIFFÉRENTES POUR RYTHMER LES PRÉSENTATIONS

BLACK MAT FINISH SUPPORTS OF DIFFERING HEIGHTS CAN BE USED TO CREATE A VARIED PRESENTATION

SOPORTES DE ACERO NEGRO DE DIFERENTES ALTURAS PARA MARCAR EL RITMO DE LAS PRESENTACIONES

230741 SUPPORT RECTANGULAIRE NIVEAU 1

RECTANGULAR TRAY, LEVEL 1
SOPORTE RECTANGULAR, NIVEL 1
L 44 X P 30,8 X H 10,8 CM
W 17 IN^{5/8} X D 12 IN^{7/8} X H 4 IN^{1/4}



230742 SUPPORT RECTANGULAIRE NIVEAU 2

RECTANGULAR TRAY, LEVEL 2
SOPORTE RECTANGULAR, NIVEL 2
L 42 X P 30,8 X H 29,8 CM
W 16 IN^{5/8} X D 12 IN^{7/8} X H 11 IN^{3/4}

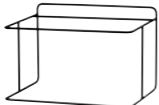

230741 + 230742 SUPPORT RECTANGULAIRE NIVEAU 1+2

RECTANGULAR TRAY, LEVEL 1+2
SOPORTE RECTANGULAR, NIVEL 1+2
L 44 X P 50 X H 29,8 CM
W 17 IN^{5/8} X D 19 IN^{11/16} X H 11 IN^{3/4}

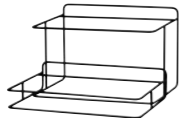

230743 SUPPORT RECTANGULAIRE NIVEAU 3

RECTANGULAR TRAY, LEVEL 3
SOPORTE RECTANGULAR, NIVEL 3
L 40 X P 30,8 X H 48,8 CM
W 15 IN^{3/4} X D 12 IN^{7/8} X H 19 IN^{3/16}

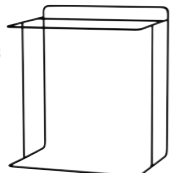

230742+230743 SUPPORT RECTANGULAIRE NIVEAU 2+3

RECTANGULAR TRAY, LEVEL 2+3
SOPORTE RECTANGULAR, NIVEL 2+3
L 42 X P 50 X H 48,8 CM
W 16 IN^{5/8} X D 19 IN^{11/16} X H 19 IN^{3/16}

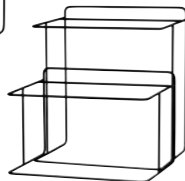

230741 + 230742+230743 SUPPORT RECTANGULAIRE NIVEAU 1+2+3

RECTANGULAR TRAY, LEVEL 1+2+3
SOPORTE RECTANGULAR, NIVEL 1+2+3
L 44 X P 68,2 X H 48,8 CM
W 17 IN^{5/8} X D 26 IN^{7/8} X H 19 IN^{3/16}

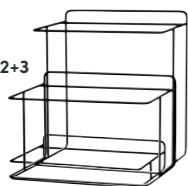

230744 CADRE ACIER POUR SUPPORT RECTANGULAIRE

STEEL FRAME FOR STAND
ESTRUCTURA DE ACERO
L 55,5 X P 35 X H 4,5 CM
W 21 IN^{7/8} X D 13 IN^{3/8} X H 1 IN^{3/4}



230749 PANIERE RECTANGULAIRE - GN 1/1

RECTANGULAR BREAD BASKET
CESTA BOLLERIA RECTANGULAR
54 X 34 X H 7 CM
21 IN^{1/4} X 13 IN^{3/8} X 2 IN^{3/4}



PANIÈRE REVERSIBLE POUR UNE PRÉSENTATION DROITE OU INCLINÉE
REVERSIBLE BASKET FOR A LEVEL OR TITLED DISPLAY
PANERA REVERSIBLE PARA UNA PRESENTACION DERECHA O INCLINADA



185021 - GN1/1 PLATEAU ACIER 18-10 NEWPORT FINITION MIROIR
SERVING TRAY STAINLESS STEEL 18-10 MIRROR FINISHED
BANDEJA RECTANGULAR ACERO 18-10 ACABADO BRILLO



230752 - GN1/1 PLATEAU VERRE ÉPAISSEUR 0,6 CM
TEMPERED GLASS TRAY THICKNESS IN^{1/4}
BANDEJA CRISTAL GROSOR 0,6 CM



202919 - GN1/1 PLATEAU BAMBOU ÉPAISSEUR 1,5 CM
OILED BAMBOO TRAY THICKNESS IN^{9/16}
BANDEJA BAMBOO GROSOR 1,5 CM



234546 - GN1/1 PLATEAU MÉLAMINE BOIS⁽³⁾ **NEW**
WOOD MELAMINE TRAY
BANDEJA MELAMINA MADERA



234547 - GN1/1 PLATEAU MÉLAMINE PIERRE⁽³⁾ **NEW**
STONE MELAMINE TRAY
BANDEJA MELAMINA PIEDRA

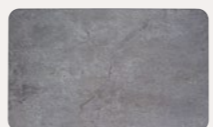

(3) COMPATIBLE LAVE-VAISSELLE
DISH WASHER SAFE
GARANTIA LAVA-VAJILLAS

(3) NON COMPATIBLE MICRO-ONDES
DON'T USE WITH MICRO-WAVE
NO VA EN EL MICRO-ONDAS



SUPPORTS À FIL RONDS
ROUND TRAYS - RONDOS BANDEJAS

POUR PANIÈRES RONDES, PLATEAUX 32 CM ET SALADIERS 28 CM

STANDS FOR ROUND BASKETS, TRAYS 12 IN^{5/8} AND SALAD BOWLS 11 IN

SOPORTES PARA RONDO, BANDEJA, BOL

230745
SUPPORT ROND BAS
ROUND STAND, LOW LEVEL
SOPORTE REDONDO BAJO
Ø 25 CM X H 13 CM
Ø 9 IN^{13/16} X H 5 IN^{1/8}

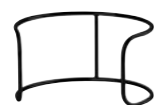

234564
SALADIER BAS GRÈS CARBONE⁽¹⁾
GREY STONEWARE LOW SALAD BOWL
ENSALADERA GRÉS TAMANO BAJO
TONO CARBONO
Ø 25,4 X 7 CM - 2,4 L
Ø 10 IN X 2 IN^{3/4} - 80 OZ^{1/8}



NEW

234563
SALADIER HAUT GRÈS CARBONE⁽¹⁾
GREY STONEWARE HIGH SALAD BOWL
ENSALADERA GRÉS TAMANO ALTO
TONO CARBONO
Ø 25,4 X 13 CM - 5,1 L
Ø 10 IN X 5 IN^{1/8} - 172 OZ^{7/16}



NEW

230748
PANIÈRE RONDE
ROUND BREAD BASKET
CESTA BOLLERÍA REDONDA
Ø 32 CM X H 8 CM
Ø 12 IN^{5/8} X H 3 IN^{1/8}



230750
PANIÈRE INDIVIDUELLE
INDIVIDUAL BREAD BASKET
CESTA BOLLERÍA INDIVIDUAL
Ø 18 CM X H 6 CM
Ø 7 IN^{1/16} X H 2 IN^{3/8}



(1) COMPATIBLE LAVE-VAISSELLE
DISH WASHER SAFE
GARANTIA LAVA-VAJILLAS
(1) COMPATIBLE MICRO-ONDES
MICROWAVE SAFE
GARANTIA MICRO-ONDAS

230746
SUPPORT ROND HAUT
ROUND STAND, HIGH LEVEL
SOPORTE REDONDO ALTO
Ø 25 CM X H 26 CM
Ø 9 IN^{13/16} X H 10 IN^{1/4}



136524
PLATEAU ROND PORCELAINE MODULO
PIE/PIZZA PLATE, FLAT
FUENTE PARA PASTEL
Ø 32 CM - 12 IN^{5/8}



234561
PLATEAU ROND MÉLAMINE BOIS⁽²⁾
WOOD MELAMINE
ROUND TRAY
BANDEJA REDONDA
MELAMINA MADERA
Ø 32 CM - 12 IN^{5/8}



NEW

234562
PLATEAU ROND MÉLAMINE PIERRE⁽²⁾
STONE MELAMINE
ROUND TRAY
BANDEJA REDONDA
MELAMINA PIEDRA
Ø 32 CM - 12 IN^{5/8}



NEW

230754
PLATEAU ROND VERRE GRIS
GREY ROUND TRAY
TEMPERED GLASS
BANDEJA CRISTAL
REDONDA
Ø 32 CM - 12 IN^{5/8}

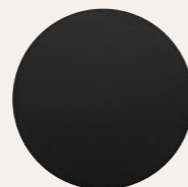

(2) COMPATIBLE LAVE-VAISSELLE
DISH WASHER SAFE
GARANTIA LAVA-VAJILLAS
(2) NON COMPATIBLE MICRO-ONDES
DON'T USE WITH MICRO-WAVE
NO VA EN EL MICRO-ONDAS



ACCESSOIRES
ACCESSORIES - ACCESORIOS

230751
PANIÈRE À BAGUETTE
BAGUETTE BASKET
CESTA PARA BAGUETTE
27 CM X H 52 CM
10 IN^{5/8} X H 20 IN^{1/2}



234559
PLANCHA AVEC MANCHE MÉLAMINE BOIS⁽¹⁾
WOOD MELAMINE BOARD
PLANCHA CON MANGO
MELAMINA MADERA
17,5 X 45 CM - 6 IN^{7/8} X 17 IN^{11/16}



NEW

234560
PLANCHA AVEC MANCHE MÉLAMINE PIERRE⁽¹⁾
STONE MELAMINE BOARD
PLANCHA CON MANGO
MELAMINA PIEDRA
17,5 X 45 CM - 6 IN^{7/8} X 17 IN^{11/16}



NEW

202631
PRÉSENTOIR DE TABLE EN PORCELAINÉ
PORCELAIN TABLE CENTER PIECE
PIEZA DE PORCELANA CENTRO DE MESA
15,5 X 7,5 CM - 6 IN^{1/8} X 2 IN^{15/16}



202632
ETIQUETTE PORCELAINÉ AVEC AIMANT + SUPPORT ACIER
PORCELAIN STICK + STAINLESS STEEL STAND + MAGNET
ETIQUETA PORCELANA + SOPORTE ACERO INOX CON IMAN
10 X 5 CM - 3 IN^{15/16} X 1 IN^{15/16}



202633
SUPPORT COUVERTS DE SERVICE PORCELAINÉ
SERVING CUTLERY DISPLAY
WHITE PORCELAIN
SOPORTE PARA PIEZAS DE SERVICIO
PORCELANA BLANCA
21 X 10 X 5 CM
8 IN^{1/4} X 3 IN^{15/16} X 1 IN^{15/16}



214185
COUPE ACIER
STAINLESS STEEL BOWL
TAZÓN ACERO
Ø 11,5 CM - Ø 4 IN^{1/2}



214182
PRÉSENTOIR ACIER MIROIR 3 TROUS
THREE HOLES STAINLESS STEEL STAND MIRROR FINISH
EXPOSITOR DE ACERO EN BRILLO 3 AGUJEROS
41 X 12,5 X 2,3 CM
16 IN^{1/8} X 4 IN^{15/16} X 1 IN^{7/8}



204499 + 184355
PINCE À SERVIR
SERVING TONG
PINZAS PARA SERVIR
29,5 CM - 11 IN^{5/8}



204498 + 101492
PINCE À PAIN
BREAD TONG
PINZAS PAN
23 CM - 9 IN^{1/16}



204496 + 101494
CISEAUX À GÂTEAUX
PASTRY SCISSORS/TONG
PINZAS PARA PASTELES
20 CM - 7 IN^{7/8}



130994
CUILLÈRE À TOAST
APPETIZER SPOON
CUCHARA APERITIVO
11,8 CM - 4 IN^{5/8}



202854
PLANCHE À PAIN BAMBOU AVEC RÉCUPÉRATEUR DE MIETTES (GN 1/1)
BAMBOO BREAD BOARD WITH CRUMB TRAY (GN 1/1)
PANERA BAMBOO CON RECOGEDOR DE MIGAS (GN 1/1)
53 X 32,5 CM - 20 IN^{7/8} X 12 IN^{13/16}



229516
COUPEAU L'ECONOME BY STARCK® POSITIONNABLE DANS LA PLANCHE
ECONOME BY STARCK® BREAD KNIFE FITS IN A SLOT IN THE BREAD BOARD
CUCHILLO DE PAN ECONOME BY STARCK® SE ENCAJA EN UNA RANURA DE LA PANERA
24 CM - 9 IN^{7/16}



217814
COUPEAU L'ECONOME ECO NATURE® POSITIONNABLE DANS LA PLANCHE
ECONOME ECO NATURE® BREAD KNIFE FITS IN A SLOT IN THE BREAD BOARD
CUCHILLO DE PAN ECONOME ECO NATURE® SE ENCAJA EN UNA RANURA DE LA PANERA
18 CM - 7 IN^{1/16}



209381
PRÉSENTOIR À GÂTEAUX ROND
ROUND APP / PIZZA / PRESENTATION STAND
EXPOSITOR DE TARTAS
Ø 25 CM - 9 IN^{13/16}



209382
Ø 32 CM - 12 IN^{5/8}



230337
BOL EVENTO GRIS PERLE
GREY EVENTO BOWL
BOL EVENTO GRIS
22 CM - 8 IN^{11/16}

202625
BOL EVENTO BLANC
WHITE EVENTO BOWL
BOL EVENTO BLANCO
22 CM - 8 IN^{11/16}

142722
BOL PORCLAINÉ MODULO
DEEP BOWL, LARGE
BOL HONDO
28 CM - 11 IN
CONTENANCE : 2,5 L
CAPACITY : 84 OZ^{21/16}
H : 12 CM - 4 IN^{3/4}

168845
CUILLÈRE À SPAGHETTI
SPAGHETTI SERVING SPOON
CUCHARA PARA ESPAGUETIS
29 CM - 11 IN^{7/16}



168846
LOUCHETTE
GRAVY LADLE
CUCHARÓN
29 CM - 11 IN^{7/16}



168844
FOURCHETTE À VIANDE
MEAT FORK
TENEDOR DE CARNE
29 CM - 11 IN^{7/16}



168843
CUILLÈRE DE SERVICE
SERVING SPOON
CUCHARA DE SERVICIO/ENSALADA
32 CM - 12 IN^{5/8}



130610
REPOSE CUILLÈRE PORCELAINÉ
SPOON REST WITH CERAMIC BOWL
CUCHARA DESCANSA EN PORCELANA
H 23,5 CM X L 11,5 CM - 9 IN^{3/4} X 4 IN^{1/2}



153193
LOUCHE ASTREE MIROIR
SOUP LADLE
CAZO
29,7 CM - 11 IN^{11/16}



(2) COMPATIBLE LAVE-VAISSÈLE
DISH WASHER SAFE
GARRANTIA LAVA-VAJILLAS
(2) NON COMPATIBLE MICRO-ONDES
DON'T USE WITH MICRO-WAVE
NO VA EN EL MICRO-ONDAS



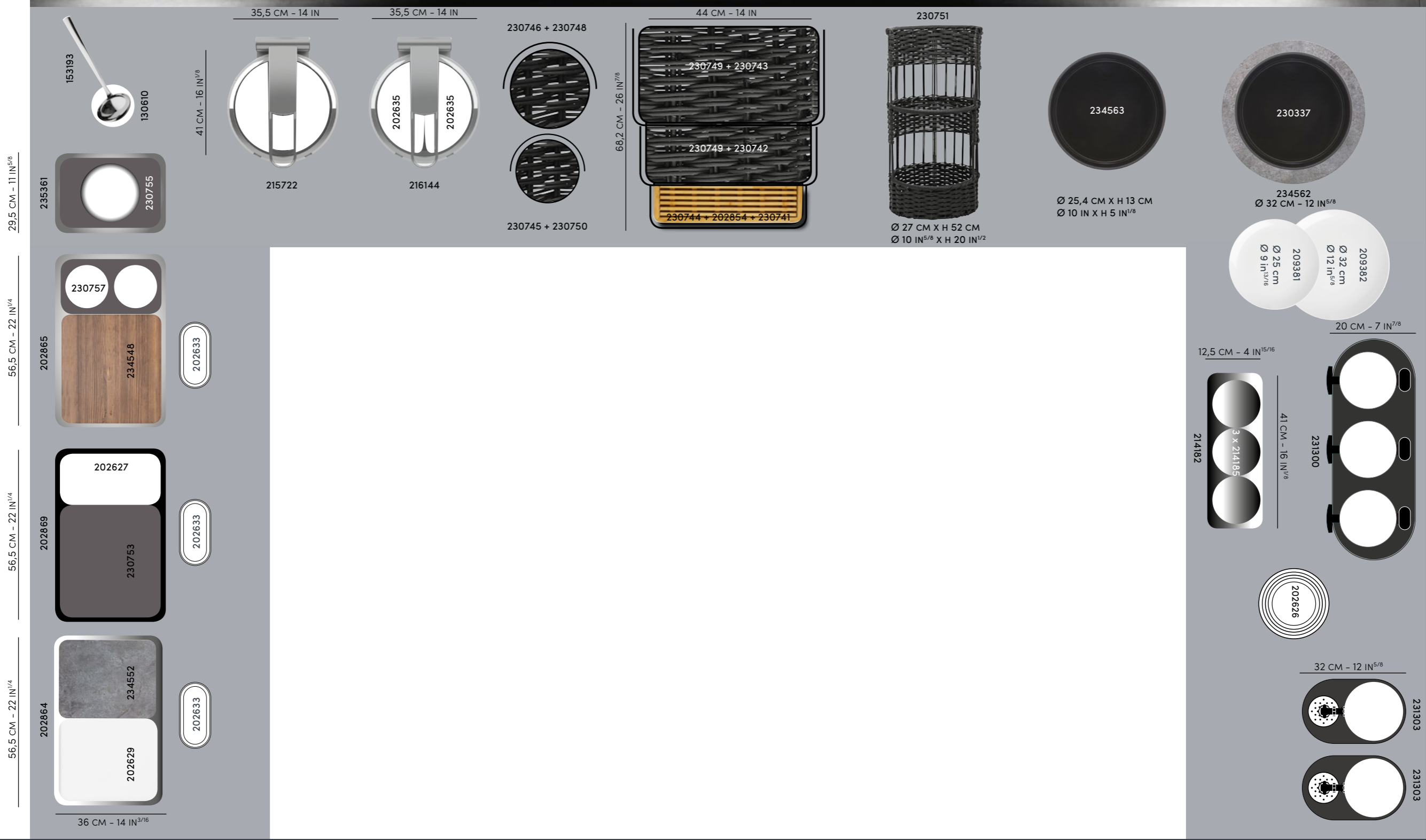

PIÈCES DÉTACHÉES

AVAILABLE INDIVIDUALLY - PIEZAS SEPARADAS

CHAFING DISH

203470
**COUVERCLE AVEC GOUTTIÈRE
ACIER ET VERRE TREMPÉ**
LID WITH STAINLESS STEEL GUTTER,
TEMPERED GLASS
TAPA EN ACERO INOX
Y VIDRIO TEMPLADO
Ø 33 CM - Ø 13 IN

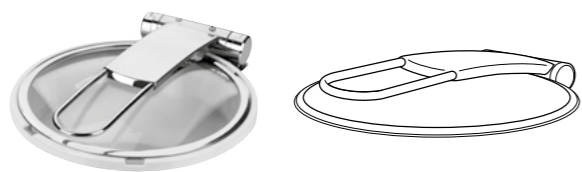

216142
**BAC ACIER
POUR CHAFING DISH**
CHAFING STAINLESS STEEL INSERT
BANDEJA DE ACERO INOXIDABLE
PARA CHAFING
Ø 35,5 X H 6,3 CM
CONTENANCE - CAPACIDAD 3L
Ø 14 X 2 IN^{1/2}
CAPACITY 100 OZ



215721
**BAC PORCELAINE
POUR CHAFING DISH**
CHAFING PORCELAIN INSERT
BANDEJA DE PORCELANA
PARA CHAFING
Ø 35,6 X H 6,3 CM
CONTENANCE - CAPACIDAD 3L
Ø 14 X 2 IN^{1/2}
CAPACITY 100 OZ



202635
**1/2 BAC PORCELAINE
POUR CHAFING DISH**
1/2 CHAFING PORCELAIN INSERT
1/2 BANDEJA DE PORCELANA
PARA CHAFING
L 29 X L15 X H 4,5 CM
CONTENANCE - CAPACIDAD 1L
11 IN^{7/16} X 5 IN^{7/8} X 1 IN^{3/4}
CAPACITY 33 OZ^{15/16}

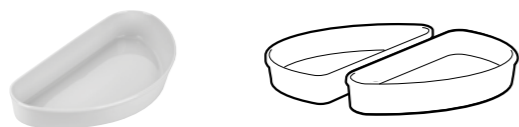

SUPPORT CHAFING
ACIER INOXYDABLE, POUR RÉSISTANCE ÉLECTRIQUE
OU PORTE-BRÛLEUR AVEC GEL COMBUSTIBLE
CHAFING STAND STAINLESS STEEL, FOR ELECTRICAL
AND/OR STERNO HEATING PURPOSES
SOPORTE PARA CHAFING DISH ACERO INOXIDABLE
PARA RESISTENCIA ELÉCTRICA O CALENTADOR
EXTERNO
Ø 35 CM X P 40 CM X H 12,5 CM
Ø 13 IN^{3/4} X D 15 IN^{3/4} X H 4 IN^{15/16}

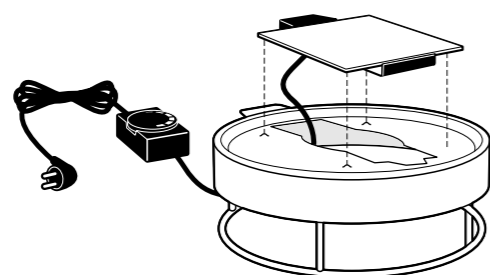

203005
FINITION MIROIR
MIRROR FINISH
ACABADO BRILLO

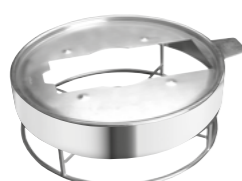

202859
FINITION BROSSÉE
BRUSHED FINISH
ACABADO SATINADO

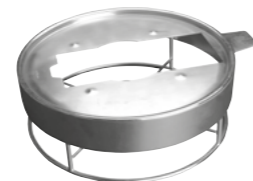

MODULE FROID
REFRIGERATED UNIT - MODULO REFRIGERADOS

202866
BAC PLASTIQUE
PLASTIC TRAY
BANDEJA
56 X 35,5 X 8 CM
22 IN^{1/16} X 14 IN X 3 IN^{1/8}



**RÉSISTANCE AVEC
RÉGULATEUR DE
TEMPÉRATURE**
202860 - 220 /240 V
203468 - 110 /120 V
HEATING ELEMENT - HEAT
ADJUSTABLE
RESISTENCIA CON REGULADOR
DE TEMPERATURA
20 X 20 CM
7 IN^{7/8} X 7 IN^{7/8}



202861
**PORTE-BRÛLEUR POUR
GEL COMBUSTIBLE ACIER**
BURNER HOLDER STEEL
QUEMADOR ACERO INOXIDABLE
Ø 9 CM - H 6 CM
Ø 3 IN^{9/16} X 2 IN^{3/8}



URNE À JUS DE FRUITS
FRUIT JUICÉ URN - DISPENSADOR DE ZUMOS

COUVERCLE URNE ACIER 18-10
LID FOR STAINLESS DISPENSER 18-10
TAPA PARA ACERO DISPENSADOR 18-10
Ø 17,9 CM - 7 IN^{17/16}

202881 202891
MIROIR BROSSÉ
MIRROR BRUSHED
ACABADO BRILLO ACABADO SATINADO



202884
TUBE ACIER POUR GLACE
ICE TUBE STAINLESS STEEL
TUBO PARA HIELO ACERO 18-10
Ø 9 CM - 3 IN^{9/16}

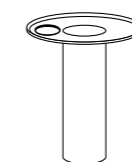

202883
FÛT CYLINDRIQUE URNE
CONTAINER FOR DISPENSER
CONTENEDOR PARA EL DISPENSADOR SAN
5L - 169 OZ^{17/16}
Ø 17,7 CM X H 25,5 CM
Ø 6 IN^{15/16} X H 10 IN^{1/16}

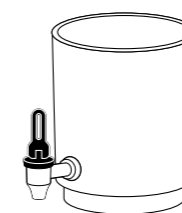

214724
ROBINET ACIER
STAINLESS STEEL FAUCET
GRIFO ACERO
+ ABS NOIR, black, negro



BASE ACIER 18-10 URNE
STAINLESS STEEL STAND FOR DISPENSER 18-10
SOPORTE ACERO PARA DISPENSADOR 18-10
Ø 17,6 CM - H 19 CM
Ø 6 IN^{15/16} X H 7 IN^{1/2}

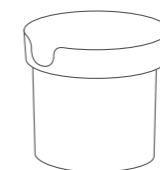

202890 202889
MIROIR BROSSÉ
MIRROR BRUSHED
ACABADO BRILLO ACABADO SATINADO

045963
GRILLE ACIER POUR GOUTTES
STAINLESS STEEL GRID DROP COLLECTOR
REJILLA DE ACERO PARA RECOGER EL GOTEO
18-10
Ø 9 CM - 3 IN^{9/16}



230758
SOCLE NOIR ACRYLIQUE URNE
STAND FOR BLACK DISPENSER
BASE DEL DISPENSADOR NEGRO
20 X 32 CM
7 IN^{7/8} X 12 IN^{5/8}
ÉPAISSEUR/ESPESOR : 2 CM
THICKNESS: 13/16 IN



DISTRIBUTEUR À CÉRÉALES
CEREALES DISPENSER - DISPENSADOR DE CEREALES

213078
**COUVERCLE DISTRIBUTEUR CEREALES
ACIER FINITION MIROIR**
LID FOR CEREAL DISPENSER, STAINLESS STEEL,
MIRROR FINISH
TAPA PARA DISPENSADOR EN BRILLO, ACERO
18-10
Ø 12,5 CM - Ø 4 IN^{15/16}



213076
**FUT CYLINDRIQUE AVEC AILETTE
ET POIGNEE DISTRIBUTEUR CEREALES**
BARREL + HANDLE + ROLLING TAP
FOR CEREAL DISPENSER
CONTENEDOR PARA EL DISPENSADOR
CON ALETA Y ASA
P 16,1 X H 42 CM - D 6 IN^{5/16} X H 16 IN^{9/16}



231301
**BASE + TUBE + SOCLE X1
DISTRIBUTEUR À CEREALES**
STAINLESS STEEL STAND + TUB
+ ACRYLIC STAND FOR CEREAL DISPENSER
BASE + TUBO + ZÓCALO DISPENSADOR
DE CEREALES
L 19 X H 27,5 CM - L 7 IN^{1/2} X H 29 IN^{3/4}



231302
**BASE + TUBE + SOCLE X3
DISTRIBUTEUR À CEREALES**
STAINLESS STEEL STAND + TUB
+ ACRYLIC STAND FOR CEREAL DISPENSER
BASE + TUBO + ZÓCALO
X3 DISPENSADOR DE CEREALES
L 50 X H 27,5 CM - L 19 IN^{17/16} X H 29 IN^{3/4}

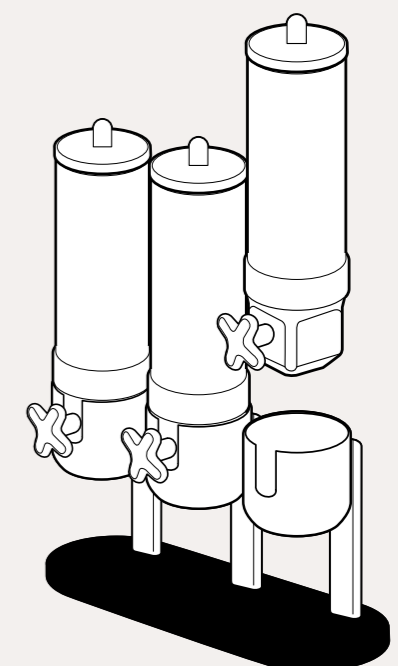



CUISINE

Véritable tradition pour DEGRENNE, le culinaire se décline en **ustensiles de cuisson, de préparation, de découpe et d'affutage**, pour inviter les chefs à la réalisation de recettes savoureuses et délicates. Les gammes coutellerie **l'Unique Sabatier** ainsi que les ustensiles de préparation de la célèbre marque **L'Econome®**, sont **gages de qualité** et témoignent d'un véritable esprit précurseur dans l'histoire de la cuisine française. Experte dans le travail de l'acier et notamment sur l'embouti, DEGRENNE présente également **Newcook Expert, une gamme d'ustensiles de cuisson 100% fabriquée en France**. En alliant **précision, technologie** Multiply et **design**, Newcook Expert promet des moments de création uniques.

KITCHENWARE

Kitchenware is a real tradition at DEGRENNE and our range comprises **cooking, preparation, slicing and sharpening utensils** to encourage chefs to make flavoursome and delicate dishes. The **Unique Sabatier** cutlery ranges and the famous **L'Econome®** brand's food preparation utensils, are a **guarantee of quality** and bear witness to a trailblazing spirit in the history of French cuisine. DEGRENNE has steel-working and specifically metal stamping expertise, and is also presenting **Newcook Expert, a range of cooking utensils entirely made in France**. Newcook Expert promises unique creative moments, as the range combines **precision, Multiply technology** and **great design**.

COCINA

Verdadera tradición para DEGRENNE, lo culinario se declina en **utensilios de cocción, de preparación, de corte y de afilado**, para invitar a los chefs a la preparación de recetas sabrosas y delicadas. Las gamas de cuchillería, **Unique Sabatier**, así como los utensilios de preparación de la famosa marca, **L'Econome®**, son garantía de calidad y dan fe de un verdadero espíritu pionero en la historia de la cocina francesa. Experta en el trabajo del acero, sobre todo en el estampado, DEGRENNE también presenta **Newcook Expert, una gama de utensilios de cocina, 100 % fabricada en Francia**. Aliando **precisión, tecnología** Multiply y **diseño**, Newcook Expert promete momentos de creación únicos.

NEWCOOK EXPERT
223992 - COUVERCLE - LID - TAPA - 28 CM - 11 IN

P.226

COUPEAU OFFICE
PARING KNIFE
CUCHILLO MONDADOR
8 CM - 3 IN^{17/16}
218590 **IDÉAL FORGÉ**



COUPEAU OFFICE
PARING KNIFE
CUCHILLO MONDADOR
10 CM - 4 IN
218587 **IDÉAL FORGÉ**
218591 **IDÉAL FORGÉ OLIVIER**



COUPEAU OFFICE BEC OISEAU
CURVED BLADE PARING KNIFE
CUCHILLON MONDADOR PICO DE PAJARO
8 CM - 3 IN^{17/16}
218585 **IDÉAL FORGÉ**



COUPEAU DE CUISINE
CHEF'S KNIFE
CUCHILLO DE COCINA
15 CM - 6 IN
218593 **IDÉAL FORGÉ**
218595 **IDÉAL FORGÉ OLIVIER**



COUPEAU DE CUISINE
CHEF'S KNIFE
CUCHILLO DE COCINA
20 CM - 8 IN
218596 **IDÉAL FORGÉ**
218599 **IDÉAL FORGÉ OLIVIER**



COUPEAU DE CUISINE
CHEF'S KNIFE
CUCHILLO DE COCINA
25 CM - 10 IN
218600 **IDÉAL FORGÉ**
218602 **IDÉAL FORGÉ OLIVIER**



COUPEAU TRANCELARD
SLICING KNIFE
CUCHILLO PARA CORTAR
15 CM - 6 IN
218609 **IDÉAL FORGÉ**



COUPEAU TRANCELARD
SLICING KNIFE
CUCHILLO PARA CORTAR
20 CM - 8 IN
218613 **IDÉAL FORGÉ**



COUPEAU TRANCELARD
SLICING KNIFE
CUCHILLO PARA CORTAR
25 CM - 10 IN
218616 **IDÉAL FORGÉ**



COUPEAU SANTOKU
SANTOKU KNIFE GRANTON EDGE
CUCHILLO SANTOKU
18 CM - 7 IN^{17/16}
218629 **IDÉAL FORGÉ**
218630 **IDÉAL FORGÉ OLIVIER**



COUPEAU FILET DE SOLE
FILETING KNIFE
CUCHILLO PARA FILETAR
15 CM - 6 IN
218611 **IDÉAL FORGÉ**

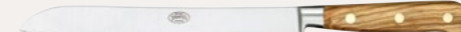
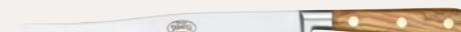

COUPEAU À JAMBON ALVÉOLÉ
HAM SLICER HOLLOW EDGE
CUCHILLO JAMONERO ALVEOLADO
30 CM - 12 IN
218583 **IDÉAL FORGÉ**

COUPEAU À DÉOSSER
BONING KNIFE
CUCHILLO DESHUESADOR
13 CM - 5 IN
218626 **IDÉAL FORGÉ**

COUPEAU À DÉOSSER
BONING KNIFE
CUCHILLO DESHUESADOR
15 CM - 6 IN
218628 **IDÉAL FORGÉ**

FUSIL À AIGUISER-ABS
SHARPENING STEEL-ABS
AFLADOR-ABS
30 CM - 12 IN
218789 **AFFUTAGE COUTELLERIE**

FUSIL À AIGUISER
SHARPENING STEEL
AFLADOR
25 CM - 10 IN
217880 **IDÉAL FORGÉ**

FUSIL À AIGUISER
SHARPENING STEEL
AFLADOR
20 CM - 8 IN
217883 **IDÉAL FORGÉ OLIVIER**

COUPEAU À DÉCOUPER YATAGAN
YATAGAN CARVING KNIFE
CUCHILLO DE TRINCHAR YATAGAN
20 CM - 8 IN
218623 **IDÉAL FORGÉ**
218625 **IDÉAL FORGÉ OLIVIER**

FOURCHETTE À VIANDE
MEAT FORK
TENEDOR DE CARNE
17 CM - 6 IN^{17/16}
217868 **IDÉAL FORGÉ**
217872 **IDÉAL FORGÉ OLIVIER**

COUPEAU À STEAK
STEAK KNIFE
CUCHILLO CHULETERO
13 CM - 5 IN
218579 **IDÉAL FORGÉ**

COUPEAU À PAIN
BREAD KNIFE
CUCHILLO DE PAN
20 CM - 8 IN
218619 **IDÉAL FORGÉ**
218622 **IDÉAL FORGÉ OLIVIER**



L'ÉCONOME® ECO NATURE
NATURAL HUE - TINTE NATURAL

L'ÉCONOME® BOIS LAQUÉ
GLOSS FINISH WOOD - MADERA LACADA

L'ÉCONOME®



217523
ÉCONOME
PEALER
PELADOR
10 CM - 4 IN



217687
COUTEAU OFFICE POINTU
PARING KNIFE
CUCHILLO MONDADOR
9 CM - 3 IN^{15/16}



226270
COUTEAU OFFICE BEC OISEAU
CURVED BLADE PARING KNIFE
CUCHILLON MONDADOR PICO DE PAJARO
6,5 CM - 2 IN^{5/8}



217804
COUTEAU À DÉCOUPER
CARVING KNIFE
CUCHILLO DE TRINCHAR
20 CM - 8 IN



217806
COUTEAU DE CUISINE
CHEF'S KNIFE
CUCHILLO DE COCINA
15 CM - 6 IN



217808
COUTEAU DE CUISINE
CHEF'S KNIFE
CUCHILLO DE COCINA
20 CM - 8 IN



217814
COUTEAU À PAIN
BREAD KNIFE
CUCHILLO DE PAN
18 CM - 7 IN^{7/8}



217528
ÉCONOME® AUBERGINE
PEELER PURPLE
PELADOR BERENJENA
10 CM - 4 IN



217529
ÉCONOME® MANDARINE
PEELER ORANGE
PELADOR MANDARINA
10 CM - 4 IN



217532
ÉCONOME® ANIS
PEELER ANISE
PELADOR ANIS
10 CM - 4 IN



217533
ÉCONOME® FUCHSIA
PEELER FUCHSIA
PELADOR FUCSIA
10 CM - 4 IN



217691
COUTEAU OFFICE POINTU AUBERGINE
PARING KNIFE PURPLE
CUCHILLO MONDADOR BERENJENA
9 CM - 3 IN^{15/16}

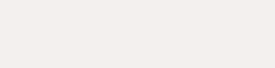

217692
COUTEAU OFFICE POINTU MANDARINE
PARING KNIFE ORANGE
CUCHILLO MONDADOR MANDARINA
9 CM - 3 IN^{15/16}



217695
COUTEAU OFFICE POINTU ANIS
PARING KNIFE ANISE
CUCHILLO MONDADOR ANIS
9 CM - 3 IN^{15/16}



217696
COUTEAU OFFICE POINTU FUCHSIA
PARING KNIFE FUCHSIA
CUCHILLO MONDADOR FUCSIA
9 CM - 3 IN^{15/16}



217795
COUTEAU OFFICE BEC OISEAU AUBERGINE
CURVED BLADE PARING KNIFE PURPLE
CUCHILLON MONDADOR PICO DE PAJARO BERENJENA
6,5 CM - 2 IN^{5/8}

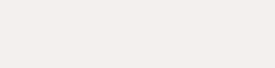

217796
COUTEAU OFFICE BEC OISEAU MANDARINE
CURVED BLADE PARING KNIFE ORANGE
CUCHILLON MONDADOR PICO DE PAJARO MANDARINA
6,5 CM - 2 IN^{5/8}



217799
COUTEAU OFFICE BEC OISEAU ANIS
CURVED BLADE PARING KNIFE ANISE
CUCHILLON MONDADOR PICO DE PAJARO ANIS
6,5 CM - 2 IN^{5/8}

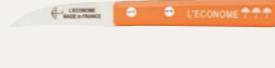

217800
COUTEAU OFFICE BEC OISEAU FUCHSIA
CURVED BLADE PARING KNIFE FUCHSIA
CUCHILLON MONDADOR PICO DE PAJARO FUCSIA
6,5 CM - 2 IN^{5/8}



217528
FLEXICONOME JULIENNE AUBERGINE
JULIENNE FLEXICONOME PURPLE
ABADEJO FLEXICONOME BERENJENA
9 CM - 3 IN^{15/16}



217538
FLEXICONOME TOMATE ANIS
TOMATO FLEXICONOME ANISE
TOMATO FLEXICONOME ANIS
9 CM - 3 IN^{15/16}



217536
FLEXICONOME UNIVERSEL FUCHSIA
UTILITY FLEXICONOME FUCHSIA
UNIVERSAL FLEXICONOME FUCSIA
9 CM - 3 IN^{15/16}



L'ÉCONOME BY STARCK® **NEW**



229514
PACK 4 PIECES - ECONOME / COUTEAU BEC OISEAU / FLEXICONOME / COUTEAU OFFICE
PACK 4 PIEZAS SET - PEELER/ CURVED BLADE PARING KNIFE/FLEXICONOME/ PARING KNIFE
PAQUETE DE 4 PIEZAS - ECONOME/BECK CUCHILLOS /FLEXICONOME/CUCHILLO MONDADOR



229515
COUTEAU DE CUISINE
CHEF'S KNIFE
CUCHILLO DE COCINA
14 CM - 5 IN^{1/2}



229516
COUTEAU À PAIN
BREAD KNIFE
CUCHILLO DE COCINA
24 CM - 9 IN^{7/8}



© MIMAGES

LA CUISINE
KITCHENWARE - COCINA

CASSEROLES SAUCEPAN - CAZO



223972
CASSEROLE
SAUCEPAN
CAZO
14 CM - 5 IN^{1/2}

223973
CASSEROLE
SAUCEPAN
CAZO
16 CM - 6 IN^{5/16}

223974
CASSEROLE
SAUCEPAN
CAZO
18 CM - 7 IN^{7/16}

223975
CASSEROLE
SAUCEPAN
CAZO
20 CM - 7 IN^{7/8}

223993
**ENSEMBLE DE
3 CASSEROLES**
SET OF 3 SAUCEPAN
SET DE 3 CAZOS
16/18/20 CM
6 IN^{5/16} TO 7 IN^{7/8}

POÊLES FRYING PAN - SARTÉN



223977
POÊLE
FRYING PAN
SARTÉN
24 CM - 9 IN^{7/16}

223979
POÊLE
FRYING PAN
SARTÉN
28 CM - 11 IN



223980
**POÊLE
ANTI-ADHÉRENTE**
NON STICK SAUCEPAN
SARTÉN ANTIADHERENTE
24 CM - 9 IN^{7/16}

223981
**POÊLE
ANTI-ADHÉRENTE**
NON STICK SAUCEPAN
SARTÉN ANTIADHERENTE
28 CM - 11 IN

SAUTEUSES SAUCEPAN - SARTÉN PARA SALTEAR



223983
**POÊLE
ANTI-ADHÉRENTE**
NON STICK SAUCEPAN
SARTÉN PARA SALTEAR
24 CM - 9 IN^{7/16}

223984
**SAUTEUSE
ANTI-ADHÉRENTE**
NON STICK SAUCEPAN
SARTÉN PARA SALTEAR
28 CM - 11 IN

COCOTTE FRENCH OVEN - OLLA



223986
**COCOTTE OVALE
AVEC COUVERCLE**
OVAL FRENCH OVEN WITH LID
OLLA OVALADA CON TAPA
24 X 30 CM - 11 IN^{13/16} X 9 IN^{7/16}

FAITOUT STEWOPOT - OLLA



223985
FAITOUT
STEWOPOT
OLLA
24 CM - 9 IN^{7/16}

COUVERCLES LIDS - TAPAS



223987
14 CM - 5 IN^{1/2}

223988
16 CM - 6 IN^{5/16}

223989
18 CM - 7 IN^{1/16}

223990
20 CM - 7 IN^{7/8}

223991
24 CM - 9 IN^{7/16}

223992
28 CM - 11 IN

CONDUCTION HOMOGENE ET OPTIMALE DE LA CHALEUR DU FOND JUSQU'EN HAUT DES PAROIS POUR UNE PARFAITE MAÎTRISE DE LA TEMPÉRATURE DE CUISSON

CORPS EXTÉRIEUR EN FINITION INOX ET INTÉRIEUR BROSSÉ

GRADUATION INTÉRIEURE DES LITRAGES

PERFORMANCES PROCHES DES QUALITÉS DE CUISSON OBTENUES AVEC DES USTENSILES EN CUIVRE OU EN FONTE

COMPATIBLE TOUS FEUX DONT INDUCTION

ACIER INOXYDABLE
STAINLESS STEEL
ACERO INOXIDABLE

ALUMINIUM
ALUMINIUM
ALUMINIO

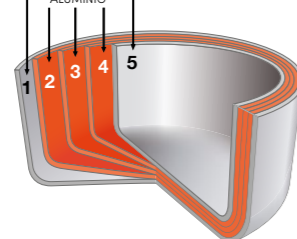

UNIFORM AND OPTIMAL HEAT CONDUCTION FROM THE BASE OF THE PAN TO THE TOP OF THE SIDES FOR A PERFECT CONTROL OF THE COOKING TEMPERATURE

OUTER BODY IN STAINLESS STEEL FINISH AND INSIDE IN BRUSHED STAINLESS STEEL

INTERNAL LITRE SCALE

THE PERFORMANCE IS CLOSE TO COOKING QUALITIES USUALLY OBTAINED FROM COOKING WITH COPPER OR CAST IRON COOKWARE

SUITABLE FOR ALL HOB TYPES INCLUDING INDUCTION

CONDUCCIÓN HOMOGENEA Y ÓPTIMA DEL CALOR DEL FONDO HASTA ARRIBA DE LAS PAREDES PARA UN PERFECTO CONTROL DE LA TEMPERATURA DE COCCIÓN

CUERPO EXTERIOR EN ACABADO DE ACERO INOXIDABLE E INTERIOR EN MATE

GRADUACIÓN INTERIOR DE LOS LITROS

RENDIMIENTOS CERCANOS A LAS CALIDADES DE COCCIÓN OBTENIDAS CON UTENSILIOS DE COBRE O HIERRO FUNDIDO

COMPATIBLE CON TODO TIPO DE FUEGOS, INCLUIDOS LO DE INDUCCIÓN



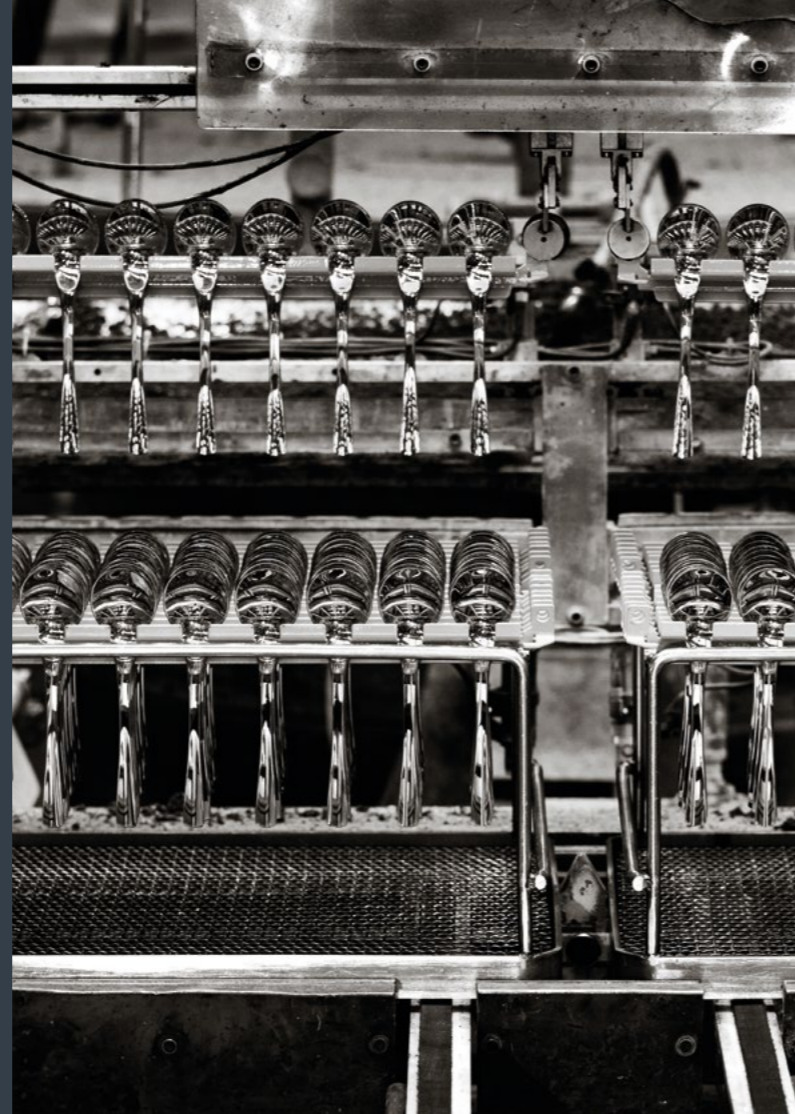

SERVICE DE RÉASSORT



DEGRENNE s'engage à vos côtés en vous offrant la possibilité d'effectuer **une commande de réassort pendant les 3 années qui suivent l'arrêt de commercialisation de nos couverts**. Ce service s'applique aux collections identifiées dans ce catalogue par ce pictogramme. Dans le cadre de ce service, **vous avez la possibilité de commander les pièces qui vous manquent, une fois par an et selon les conditions définies** : contactez nos équipes commerciales pour toute demande. Le service de réassort est valable pour les pièces suivantes : Fourchette de table – Cuillère de table – Couteau de table (excepté couteaux lourds) Fourchette à poisson – Couteau à poisson – Fourchette à dessert – Cuillère à dessert – Couteau à dessert (excepté couteaux lourds) – Cuillère à café – Cuillère à moka.

REPLACEMENT PRODUCT SERVICE



DEGRENNÉ enables you to **order replacement products for a further three years after cutlery is discontinued**. This service applies to the collections bearing the logo in the catalogue. This service enables you to **order any items you need once a year and in accordance with the following terms and conditions**: please contact our sales teams if you need to order any products. The replacement products service is available for the following products: table forks, tablespoons, table knives (excluded heavy knives), tea spoons and moka spoons.

SERVICIOS



DEGRENNÉ se compromete a ofrecerle la **posibilidad de efectuar un pedido de renovación de existencias durante los 3 años siguientes al final de la comercialización de nuestros cubiertos**. Ese servicio se aplica a las colecciones identificadas en este catálogo con el pictograma. En el marco de ese servicio, **tiene la posibilidad de pedir las piezas que le falten, una vez al año y según las condiciones definidas**: póngase en contacto con nuestros equipos comerciales para cualquier solicitud. El servicio de renovación de existencias es válido para las siguientes piezas : Tenedor de mesa – Cuchara de mesa – Cuchillo de mesa (salvo cuchillos pesados) – Tenedor de pescado – Cuchillo de pescado – Tenedor de postre – Cuchara de postre – Cuchillo de postre (salvo cuchillos pesados) – Cucharilla de café – Cucharilla de moka.



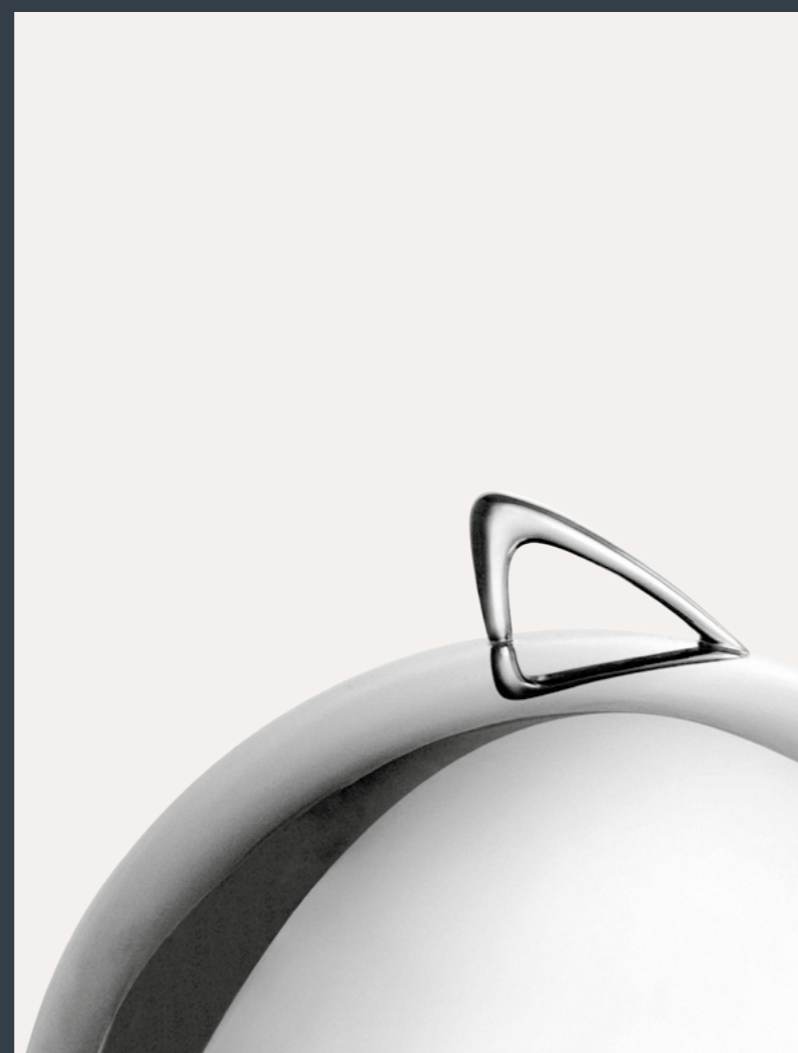

SERVICE DE PERSONNALISATION

Créez votre table personnalisée grâce au savoir-faire DEGRENNE. **DEGRENNE rend votre table unique grâce à ses services de personnalisation** : couverts, verres, plateaux ou vaisselle, découvrez un large choix de produits et de finitions. Chaque projet de personnalisation est un **service sur-mesure** qui fait l'objet d'une **étude personnalisée** par nos commerciaux.

PERSONNALIZATION SERVICE

Use DEGRENNE's expertise to create your own table. **DEGRENNE's personalization service can make your table unique**: explore our wide range of products and finishes, including cutlery, glasses, trays and tableware. Our sales executives deliver a **bespoke service for each and every personalisation order**.

SERVICIO DE PERSONNALIZACIÓN

Cree su mesa personalizada gracias al saber hacer de DEGRENNE. **DEGRENNE hace que su mesa sea única gracias a sus servicios de personalización**: cubiertos, copas, bandejas o vajilla, descubra una amplia elección de productos y de acabados. Cada proyecto de personalización es un **servicio a medida** que es objeto de un **estudio personalizado** por parte de nuestros comerciales.





VERRERIE

GLASSWARE
COPAS

AJOUTEZ VOTRE LOGO SUR LE PIED DU VERRE
AJOUTEZ VOTRE LOGO OU UN TRAIT DE JAUGE SUR LA PARISSON
(LE LOGO SUR LA PARISSON PEUT ÉGALEMENT FAIRE OFFICE DE JAUGE)

ADD YOUR LOGO TO THE BASE OF THE GLASS
ADD YOUR LOGO OR A MEASURE MARKING ON THE BOWL
(THE LOGO ON THE BOWL CAN ALSO BE USED AS THE MEASURE MARKING)

AÑADA SU LOGOTIPO EN LA BASE DE LA COPA
AÑADA SU LOGOTIPO O UN INDICADOR DE NIVEL EN EL CÁLIZ
(EL LOGOTIPO EN EL CÁLIZ TAMBIÉN PUEDE SERVIR COMO INDICADOR DE NIVEL)



VAISSELLE

TABLEWARE
VAJILLA

AJOUTEZ VOTRE LOGO
RÉALISEZ UN DÉCOR SPÉCIFIQUE
APPLIQUEZ UN FILET DE LA COULEUR DE VOTRE CHOIX

ADD YOUR LOGO
ADD A SPECIAL PATTERN
APPLY A THIN STRIPE OF THE COLOUR OF YOUR CHOICE

AÑADA SU LOGOTIPO
REALICE UNA DECORACIÓN ESPECÍFICA
APLIQUE UN BORDE DE COLOR DE SU ELECCIÓN





COUVERTS & PLATERIE

FLATWARE
CUBIERTOS

HOLLOWWARE
ORFEBRERÍA

AJOUTEZ VOTRE LOGO : EN FONCTION DE VOS ATTENTES, NOUS PROPOSONS LA GRAVURE LASER POUR UNE GRANDE PRÉCISION OU LE MARQUAGE AU POINÇON POUR UNE TENUE INALTÉRABLE DANS LE TEMPS

ADD YOUR LOGO : IN ACCORDANCE WITH YOUR REQUIREMENTS, WE OFFER LASER ENGRAVING IF HIGH PRECISION IS NEEDED, OR ALTERNATIVELY METAL STAMPING FOR ITEMS NEEDING TO STAND THE TEST OF TIME

AÑADA SU LOGOTIPO: EN FUNCIÓN DE SUS EXPECTATIVAS, LE PROPONEMOS EL GRABADO LÁSER PARA UNA GRAN PRECISIÓN O EL MARCADO CON PUNZÓN PARA UNA RESISTENCIA EN EL TIEMPO INALTERABLE



PERSONNALISEZ VOTRE FINITION

PERSONALIZE THE FINISH
PERSONALICE SU ACABADO



L'ARGENTURE AVEC POINÇON DE MAÎTRE : ARGENTURE DE CLASSE I (33 MICRONS POUR LES ARTICLES À USAGE FRÉQUENT) OU ARGENTURE QUALITÉ HÔTELIÈRE (10 MICRONS)

SILVER PLATING WITH A MAKER'S MARK: CLASS I SILVER PLATING (33 MICRONS FOR FREQUENTLY USED ITEMS) OR HOTEL QUALITY SILVER-PLATING (10 MICRONS)

LA PLATEADURA CON PUNZÓN DE MAESTRO: PLATEADURA DE CLASE I (33 MICRONES PARA LOS ARTÍCULOS DE USO FRECUENTE) O PLATEADURA DE CALIDAD HOTELERA (10 MICRONES)



LA DORURE : DORURE À L'OR FIN DES COUVERTS OU DE CERTAINES PARTIES DES COUVERTS

GILDING : CUTLERY OR ALTERNATIVELY SOME SECTIONS OF CUTLERY CAN BE GILDED WITH FINE GOLD

LA DORADURA : DORADURA CON ORO FINO DE LOS CUBIERTOS O DE ALGUNAS PARTES DE LOS CUBIERTOS



LA FINITION BROSSÉE OU SATINÉE : POLISSAGE SPÉCIFIQUE DES COUVERTS OU DES ACCESSOIRES DE PLATERIE POUR UN RENDU MAT

BRUSHED OR SATIN FINISH: SPECIALLY POLISHED CUTLERY AND HOLLOWWARE ACCESSORIES FOR A MATT FINISH

EL ACABADO MATE O SATINADO : PULIDO ESPECÍFICO DE LOS CUBIERTOS O DE LOS ACCESORIOS DE PLATERÍA PARA UN ACABADO MATE



LA FINITION ÉTAÏN : POLISSAGE SPÉCIFIQUE DES COUVERTS POUR UN EFFET VIEILLI FAÇON ÉTAÏN

PEWTER FINISH: SPECIALLY POLISHED CUTLERY FOR A PEWTER-STYLE ANTIQUE EFFECT

EL ACABADO DE ESTAÑO : PULIDO ESPECÍFICO DE LOS CUBIERTOS PARA UN EFECTO ENVEJECIDO TIPO ESTAÑO

LA FINITION PVD : PROCÉDÉ DE MÉTALLISATION QUI PERMET DE RÉALISER UN PLACAGE IONIQUE, DISPONIBLE DANS LES COLORIS NOIR, DORÉ, CUIVRE ET HOLOGRAPHIC SOUS CONDITIONS PARTICULIÈRES, CONTACTEZ NOS ÉQUIPES.

PVD FINISH: VACUUM DEPOSIT METALLIZATION PROCESS. AVAILABLE IN BLACK, GOLD, COPPER AND HOLOGRAPHIC COLORS UNDER SPECIAL CONDITIONS, CONTACT OUR SALES TEAMS.

RECUBRIMIENTO PVD: PROCEDIMIENTO DE METALIZACIÓN POR DEPÓSITO AL VACÍO. DISPONIBLE EN LOS COLORIDOS NEGRO, DORADO, COBRE Y HOLOGRÁFICA BAJO CONDICIONES PARTICULARES, PÓNGASE EN CONTACTO CON NUESTROS EQUIPOS.



Handwriting practice area on the left page, consisting of 25 horizontal dotted lines.

Handwriting practice area on the right page, consisting of 25 horizontal dotted lines.



Handwriting practice area on the left page, consisting of 25 horizontal dotted lines.

Handwriting practice area on the right page, consisting of 25 horizontal dotted lines.





DESCENTE INTERNATIONALE
INTERNATIONAL RANGE
GAMA INTERNACIONAL



SÉLECTION DEGRENNE :
Produits emblématiques de la
marque disponibles rapidement
pour vos commandes prioritaires

DEGRENNÉ'S SELECTION :
The brand's flagship products made available
quickly for your priority product orders

SELECCION DEGRENNE :
Productos emblemáticos de la marca
disponibles rápidamente para sus pedidos
prioritarios



GARANTIE MICRO-ONDES
MICROWAVE SAFE
GARANTÍA MICRO-ONDAS



GARANTIE LAVE-VAISSELLE
DISHWASHER SAFE
GARANTÍA LAVA-VAJILLAS



GARANTIE CONGÉLATEUR
FREEZER SAFE
GARANTÍA CONGELADOR



GARANTIE FOUR
OVEN SAFE
GARANTÍA HORNO



**FINITION MÉTAL ARGENTÉ - ARGENTURE
CLASSE 1 - 33 MICRONS (POUR LES
ARTICLES À USAGE FRÉQUENT)**
SILVER PLATED FINISH - CLASS 1 SILVERPLATING -
33 MICRONS
ACABADO PLATEADO - TIPO CLASE 1 - 33 MICRAS



**ARGENTURE QUALITÉ HÔTELIÈRE -
10 MICRONS**
SILVER PLATED HOTEL QUALITY- 10 MICRONS
ACABADO HOTEL QUALITY - 10 MICRONES



FINITION MIROIR
MIRROR FINISH
ACABADO BRILLO



FINITION SATINÉE
SATIN FINISH
ACABADO CEPILLADO



FINITION VINTAGE
VINTAGE FINISH
ACABADO VINTAGE



FORGÉ
FORGED
FORJADO

18%

18-10

ACIER INOXYDABLE
STAINLESS STEEL
ACERO INOXIDABLE



EPAISSEUR FOURCHETTE DE TABLE
THICKNESS TABLE FORK
ESPESOR TENEDOR DE MESA



RÉASSORT
REPLACEMENT
RENOVACIÓN



REVÊTEMENT PVD
PVD COATING
REVESTIMIENTO PVD



VERRE
GLASS
CRISTAL



**SHQ/ SODOCALCIQUE
HAUTE QUALITÉ**
HIGH QUALITY SODA - LIME
SODOCALCICO ALTA CALIDAD



CRISTALLIN HAUTE QUALITÉ
HQ LOW LEAD CRYSTAL
CRISTALINO ALTA CALIDAD



**VERRE SOUFFLÉ BOUCHE TEINTÉ
DANS LA MASSE**
HAND-BLOWN INTEGRALLY DYED GLASS
VASO SOPLADO A BOCA, PINTADO EN MASA



1000 CYCLES GARANTIS MINIMUM
1000 WASH CYCLES GUARANTEED
1000 CICLOS DE LAVADO GARANTIZADOS



PORCELAINE
PORCELAIN
PORCELANA



PORCELAINE DE LIMOGES
LIMOGES PORCELAIN
PORCELANA DE LIMOGES



AIMANTÉ
WITH MAGNET
CON IMÁN



GRÈS
STONEWARE
ARENISCA

MARQUES DÉPOSÉES/COPYRIGHTS / MARCAS REGISTRADAS



L'ECONOME®

LAGUIOLLE®
ROSSIGNOL

FRANCE USA

SIEGE SOCIAL / HEAD OFFICE / SEDE SOCIAL
SERVICE CLIENTS / CUSTOMER SERVICES / ATENCIÓN AL CLIENTE

RUE GUY DEGRENNE - BP 50056
14502 VIRE CEDEX
FRANCE
TEL : +33 (0)2 31 66 44 15

OTHER COUNTRIES / OTROS PAÍSES
TEL : +33 (0)2 31 66 44 92

infohotel@degrenne.fr

FILIALE USA - US SUBSIDIARY

DNA/DEGRENNÉ NORTH AMERICA INC.
390 GEORGE STREET - SUITE 404 - NEW BRUNSWICK
NJ 08901 USA
TEL : 732 565 0820
FAX : 732 565 0828

csrv.dna@degrenneparis.com
www.degrenneparis.us

DIRECTION GÉNÉRALE / GENERAL MANAGEMENT / DIRECCIÓN GENERAL
DIRECTION MARKETING - MARKETING DIVISION - DIRECCIÓN DE MARKETING
DIRECTION COMMERCIALE - SALES DIVISION - DIRECCIÓN COMERCIAL

SHOWROOMS (SUR RENDEZ-VOUS)
PARIS (89 RUE LA BOÉTIE - 75008 PARIS)
NEW YORK (41 MADISON)

89 RUE LA BOÉTIE
75008 PARIS
FRANCE



FRANCE
infohotel@degrenne.fr
Tel : +33 (0)2 31 66 44 15

OTHER COUNTRIES/OTROS PAISES
infohotel@degrenne.fr
Tel : +33 (0)2 31 66 44 92

FILIALE USA/US SUBSIDIARY
csr.v.dna@degrenneparis.com
Tel : 732 565 0820



www.pro.degrenne.fr